

**Agilent E5052A Signal Source Analyzer**

# **VBA Programmer's Guide**

**Third Edition**

**FIRMWARE REVISIONS**

This manual applies directly to instruments that have the firmware revision 1.50.  
For additional information about firmware revisions, see Appendix A.



**Agilent Technologies**

**Agilent Part No. E5052-90022**

**February 2005**

Printed in Japan

---

## Notices

The information contained in this document is subject to change without notice.

This document contains proprietary information that is protected by copyright. All rights are reserved. No part of this document may be photocopied, reproduced, or translated to another language without the prior written consent of Agilent Technologies.

Microsoft®, MS-DOS®, Windows®, Visual C++®, Visual Basic®, VBA® and Excel® are registered

UNIX is a registered trademark in U.S. and other countries, licensed exclusively through X/Open Company Limited.

Portions ©Copyright 1996, Microsoft Corporation. All rights reserved.

© Copyright 2004, 2005 Agilent Technologies

---

## Manual Printing History

The manual's printing date and part number indicate its current edition. The printing date changes when a new edition is printed (minor corrections and updates that are incorporated at reprint do not cause the date to change). The manual part number changes when extensive technical changes are incorporated.

August 2004	First Edition (part number: E5052-90002)
October 2004	Second Edition (part number: E5052-90012, changes for firmware version 1.10)
February 2005	Third Edition (part number: E5052-90022, changes for firmware version 1.50)

---

## Typeface Conventions

Sample (bold)	Boldface type is used when a term is defined or emphasized.
<i>Sample (Italic)</i>	Italic type is used for emphasis and for titles of manuals and other publications.
<b>[Sample]</b>	Indicates the hardkey whose key label is “Sample”.
<b>[Sample] - Item</b>	Indicates a series of key operations in which you press the <b>[Sample]</b> key, make the item called “Item” on the displayed menu blink by using the [ ↓ ] or in other ways, and then press the <b>[Enter]</b> key.

---

## Documentation Map

The following manuals are available for the Agilent E5052A.

- ***User’s Guide (Part Number E5052-900x0, attached to Option ABA)***  
This manual describes most of the basic information needed to use the E5052A. It provides a function overview, detailed operation procedure for each function (from preparation for measurement to analysis of measurement results), measurement examples, specifications, and supplemental information. For programming guidance on performing automatic measurement with the E5052A, please see the *Programming Manual*.
- ***Programmer’s Guide (Part Number E5052-900x1, attached to Option ABA)***  
This manual provides programming information for performing automatic measurement with the E5052A. It includes an outline of remote control, procedures for detecting measurement start (trigger) and end (sweep end), application programming examples, a command reference, and related information.
- ***VBA Programmer’s Guide (Part Number E5052-900x2, attached to Option ABA)***  
This manual describes programming information for performing automatic measurement with internal controller. It includes an outline of VBA programming, some sample programming examples, a COM object reference, and related information.

---

### NOTE

The number position shown by “x” in the part numbers above indicates the edition number.



<b>1. Making Effective Use of This Manual</b>	
Contents of This Manual . . . . .	24
How to Use This Manual . . . . .	26
Looking Up COM Objects . . . . .	26
How to Code the Corresponding Commands . . . . .	26
<b>2. Introduction to VBA Programming</b>	
Introduction to the E5052A Macro Function . . . . .	28
Overview of Control System Based on Macro Function . . . . .	29
Implementing a control system . . . . .	29
Control methods . . . . .	30
E5052A Overview of COM Objects . . . . .	31
About COM objects . . . . .	31
Using COM objects to control the E5052A . . . . .	32
Major control difference between COM objects and SCPI commands . . . . .	32
<b>3. Operation Basics of the E5052A's VBA</b>	
Displaying Visual Basic Editor . . . . .	34
Initial Screen of Visual Basic Editor . . . . .	34
Closing Visual Basic Editor . . . . .	35
Switching to the E5052A Measurement Screen . . . . .	36
Necessary Preparation Before Coding . . . . .	37
A Project and Three Types of Modules . . . . .	37
Displaying a Code Window . . . . .	38
Coding a VBA Program . . . . .	42
User Interface Elements of a Code Window . . . . .	42
Auto-complete Feature . . . . .	44
Saving a VBA Program . . . . .	45
Saving a project file . . . . .	45
Saving a module (exporting) . . . . .	46
Loading a VBA Program . . . . .	48
Loading a project . . . . .	48
Loading a module (importing) . . . . .	49
Running a VBA Program . . . . .	51
Running a previous loaded VBA program . . . . .	51
Loading and executing program in batch process . . . . .	53
Stopping a VBA Program . . . . .	54
Breaking a running macro via the dialog box . . . . .	54
Abruptly terminating a VBA program . . . . .	55
Errors and Debugging . . . . .	56
Types of errors . . . . .	56
Using a debug tool . . . . .	58
Printing Output Values in the Echo Window . . . . .	64
Entering values output to the echo window . . . . .	64
Opening the echo window . . . . .	64
Clearing output values in the echo window . . . . .	64
Changing character size in echo window . . . . .	64
Using VBA Online Help . . . . .	65

---

# Contents

Accessing VBA Online Help .....	65
Using Advanced Techniques .....	67
Accessing a list of E5052A COM objects .....	67
Using automatic library references .....	68
<b>4. Controlling the E5052A</b>	
Detecting End of Measurement .....	70
Using the Status Register .....	70
Using Event Interruption feature .....	71
Reading/Writing Measurement Data .....	72
Limit Test .....	74
Using Commands to define Limit Lines .....	74
Reading Limit Lines from Files .....	75
Executing a Procedure with a Softkey (user menu function) .....	76
Preparing to use the User Menu Function .....	76
How to use the User Menu Function .....	77
Simple usage example .....	78
Argument for event occurrence .....	80
Controlling VBA Externally .....	81
Executing VBA Using External Controller .....	81
Receiving the Termination of VBA Using External Controller .....	81
Using User-defined Register .....	82
Using User-defined Variables .....	85
<b>5. User Defined Window</b>	
Overview .....	88
How to use the User Defined Window .....	89
Printing Measurement Data in the User Define Window .....	89
Analysis Functions and Save/Recall Functions .....	92
<b>6. Controlling Peripherals</b>	
Overview .....	94
Preparation .....	94
Programming with VISA .....	95
STEP 1. Starting Up VISA System .....	96
STEP 2. Connection .....	96
STEP 3. Communication .....	97
STEP 4. Disconnection .....	98
<b>7. COM Object Reference</b>	
COM Object Model .....	100
Application Objects .....	100
SCPI Objects .....	101
Notational Rules of COM Objects .....	102
Syntax .....	102
Description .....	102
Variable .....	103
Examples .....	103

Equivalent Key . . . . .	103
Application Objects . . . . .	104
NAME . . . . .	104
Parse . . . . .	104
VBVersion . . . . .	105
SCPI Objects . . . . .	106
SCPI.ABORT . . . . .	106
SCPI.CALCulate.FP(1-1).ALLTrace.ACTive . . . . .	106
SCPI.CALCulate.FP(1-1).ALLTrace.BDMarker.X.COUPle.STATe . . . . .	106
SCPI.CALCulate.FP(1-1).ALLTrace.LIMit.FAIL . . . . .	107
SCPI.CALCulate.FP(1-1).ALLTrace.MARKer.COUPle.STATe . . . . .	107
SCPI.CALCulate.FP(1-1).ALLTrace.MARKer.DISCrete.STATe . . . . .	108
SCPI.CALCulate.FP(1-1).ALLTrace.MARKer.REFerence.NUMBer . . . . .	108
SCPI.CALCulate.FP(1-1).ALLTrace.MARKer.REFerence.STATe . . . . .	108
SCPI.CALCulate.FP(1-1).DATA.RDATa . . . . .	109
SCPI.CALCulate.FP(1-1).DATA.TDATa . . . . .	109
SCPI.CALCulate.FP(1-1).DATA.XDATa . . . . .	110
SCPI.CALCulate.FP(1-1).TRACe(1-4).ALLMarker.ACTive . . . . .	110
SCPI.CALCulate.FP(1-1).TRACe(1-4).ALLMarker.SEARCh.DOMain.X . . . . .	110
SCPI.CALCulate.FP(1-1).TRACe(1-4).ALLMarker.SEARCh.DOMain.Y . . . . .	111
SCPI.CALCulate.FP(1-1).TRACe(1-4).ALLMarker.SEARCh.PEAK . . . . .	111
SCPI.CALCulate.FP(1-1).TRACe(1-4).BDMarker.X.CENTer . . . . .	111
SCPI.CALCulate.FP(1-1).TRACe(1-4).BDMarker.X.SPAN . . . . .	112
SCPI.CALCulate.FP(1-1).TRACe(1-4).BDMarker.X.STARt . . . . .	112
SCPI.CALCulate.FP(1-1).TRACe(1-4).BDMarker.X.STATe . . . . .	112
SCPI.CALCulate.FP(1-1).TRACe(1-4).BDMarker.X.STOP . . . . .	113
SCPI.CALCulate.FP(1-1).TRACe(1-4).BDMarker.Y.CENTer . . . . .	113
SCPI.CALCulate.FP(1-1).TRACe(1-4).BDMarker.Y.SPAN . . . . .	114
SCPI.CALCulate.FP(1-1).TRACe(1-4).BDMarker.Y.STARt . . . . .	114
SCPI.CALCulate.FP(1-1).TRACe(1-4).BDMarker.Y.STATe . . . . .	115
SCPI.CALCulate.FP(1-1).TRACe(1-4).BDMarker.Y.STOP . . . . .	115
SCPI.CALCulate.FP(1-1).TRACe(1-4).DATA.COPY . . . . .	115
SCPI.CALCulate.FP(1-1).TRACe(1-4).DATA.FDATa . . . . .	116
SCPI.CALCulate.FP(1-1).TRACe(1-4).DATA.FMEMory . . . . .	116
SCPI.CALCulate.FP(1-1).TRACe(1-4).DATA.UDATa . . . . .	117
SCPI.CALCulate.FP(1-1).TRACe(1-4).DATA.UMEMory . . . . .	117
SCPI.CALCulate.FP(1-1).TRACe(1-4).FORMat.FREQuency . . . . .	118
SCPI.CALCulate.FP(1-1).TRACe(1-4).FUNCTion.DOMain.X . . . . .	118
SCPI.CALCulate.FP(1-1).TRACe(1-4).FUNCTion.DOMain.Y . . . . .	119
SCPI.CALCulate.FP(1-1).TRACe(1-4).FUNCTion.STATistics.DATA . . . . .	119
SCPI.CALCulate.FP(1-1).TRACe(1-4).FUNCTion.STATistics.MEMory_Q . . . . .	119
SCPI.CALCulate.FP(1-1).TRACe(1-4).FUNCTion.TYPE . . . . .	120
SCPI.CALCulate.FP(1-1).TRACe(1-4).HOLD . . . . .	120
SCPI.CALCulate.FP(1-1).TRACe(1-4).LIMit.FAIL . . . . .	120
SCPI.CALCulate.FP(1-1).TRACe(1-4).LIMit.LOWer.LDATa . . . . .	121
SCPI.CALCulate.FP(1-1).TRACe(1-4).LIMit.LOWer.SEGMent.CLEar . . . . .	121
SCPI.CALCulate.FP(1-1).TRACe(1-4).LIMit.LOWer.SEGMent.COUNT . . . . .	121
SCPI.CALCulate.FP(1-1).TRACe(1-4).LIMit.LOWer.SEGMent.DATA . . . . .	122
SCPI.CALCulate.FP(1-1).TRACe(1-4).LIMit.REPort.DATA . . . . .	122

SCPI.CALCulate.FP(1-1).TRACe(1-4).LIMit.STATe . . . . .	122
SCPI.CALCulate.FP(1-1).TRACe(1-4).LIMit.UPPer.LDATA . . . . .	123
SCPI.CALCulate.FP(1-1).TRACe(1-4).LIMit.UPPer.SEGMent.CLEAr . . . . .	123
SCPI.CALCulate.FP(1-1).TRACe(1-4).LIMit.UPPer.SEGMent.COUNt . . . . .	123
SCPI.CALCulate.FP(1-1).TRACe(1-4).LIMit.UPPer.SEGMent.DATA . . . . .	124
SCPI.CALCulate.FP(1-1).TRACe(1-4).MARKer(1-6).SEARch.EXECute.LPEAk . . . . .	124
SCPI.CALCulate.FP(1-1).TRACe(1-4).MARKer(1-6).SEARch.EXECute.LTARget . . . . .	124
SCPI.CALCulate.FP(1-1).TRACe(1-4).MARKer(1-6).SEARch.EXECute.MAXimum . . . . .	125
SCPI.CALCulate.FP(1-1).TRACe(1-4).MARKer(1-6).SEARch.EXECute.MINimum . . . . .	125
SCPI.CALCulate.FP(1-1).TRACe(1-4).MARKer(1-6).SEARch.EXECute.PEAK . . . . .	125
SCPI.CALCulate.FP(1-1).TRACe(1-4).MARKer(1-6).SEARch.EXECute.RPEAk . . . . .	125
SCPI.CALCulate.FP(1-1).TRACe(1-4).MARKer(1-6).SEARch.EXECute.RTARget . . . . .	125
SCPI.CALCulate.FP(1-1).TRACe(1-4).MARKer(1-6).SEARch.EXECute.TARGet . . . . .	126
SCPI.CALCulate.FP(1-1).TRACe(1-4).MARKer(1-6).SEARch.PEAK.EXCursion . . . . .	126
SCPI.CALCulate.FP(1-1).TRACe(1-4).MARKer(1-6).SEARch.PEAK.POLarity . . . . .	126
SCPI.CALCulate.FP(1-1).TRACe(1-4).MARKer(1-6).SEARch.TARGet.TRANsition . . . . .	127
SCPI.CALCulate.FP(1-1).TRACe(1-4).MARKer(1-6).SEARch.TARGet.Y . . . . .	127
SCPI.CALCulate.FP(1-1).TRACe(1-4).MARKer(1-6).SEARch.TRACKing.TYPE . . . . .	128
SCPI.CALCulate.FP(1-1).TRACe(1-4).MARKer(1-6).STATe . . . . .	128
SCPI.CALCulate.FP(1-1).TRACe(1-4).MARKer(1-6).X . . . . .	128
SCPI.CALCulate.FP(1-1).TRACe(1-4).MARKer(1-6).Y . . . . .	129
SCPI.CALCulate.FP(1-1).TRACe(1-4).MATH.FUNCTion . . . . .	129
SCPI.CALCulate.FP(1-1).TRACe(1-4).MATH.MEMorize . . . . .	129
SCPI.CALCulate.FP(1-1).TRACe(1-4).PARAmeter . . . . .	130
SCPI.CALCulate.FP(1-1).TRACe(1-4).REFerence.FREQuency . . . . .	130
SCPI.CALCulate.FP(1-1).TRACe(1-4).SAPerture . . . . .	130
SCPI.CALCulate.FP(1-1).TRACe(1-4).SMOothing.APERture . . . . .	131
SCPI.CALCulate.FP(1-1).TRACe(1-4).SMOothing.STATe . . . . .	131
SCPI.CALCulate.PN(1-1).ALLTrace.LIMit.FAIL . . . . .	131
SCPI.CALCulate.PN(1-1).ALLTrace.MARKer.COUPle.STATe . . . . .	132
SCPI.CALCulate.PN(1-1).ALLTrace.MARKer.DISCrete.STATe . . . . .	132
SCPI.CALCulate.PN(1-1).ALLTrace.MARKer.REFerence.NUMBer . . . . .	133
SCPI.CALCulate.PN(1-1).ALLTrace.MARKer.REFerence.STATe . . . . .	133
SCPI.CALCulate.PN(1-1).DATA.CARRier . . . . .	133
SCPI.CALCulate.PN(1-1).DATA.PDATA . . . . .	134
SCPI.CALCulate.PN(1-1).DATA.RDATA . . . . .	134
SCPI.CALCulate.PN(1-1).DATA.XDATA . . . . .	135
SCPI.CALCulate.PN(1-1).TRACe(1-1).ALLMarker.ACTive . . . . .	135
SCPI.CALCulate.PN(1-1).TRACe(1-1).ALLMarker.SEARch.DOMain.X . . . . .	135
SCPI.CALCulate.PN(1-1).TRACe(1-1).ALLMarker.SEARch.DOMain.Y . . . . .	136
SCPI.CALCulate.PN(1-1).TRACe(1-1).ALLMarker.SEARch.PEAK . . . . .	136
SCPI.CALCulate.PN(1-1).TRACe(1-1).BDMarker.X.CENTer . . . . .	136
SCPI.CALCulate.PN(1-1).TRACe(1-1).BDMarker.X.SPAN . . . . .	137
SCPI.CALCulate.PN(1-1).TRACe(1-1).BDMarker.X.STARt . . . . .	137
SCPI.CALCulate.PN(1-1).TRACe(1-1).BDMarker.X.STATe . . . . .	138
SCPI.CALCulate.PN(1-1).TRACe(1-1).BDMarker.X.STOP . . . . .	138
SCPI.CALCulate.PN(1-1).TRACe(1-1).BDMarker.Y.CENTer . . . . .	138
SCPI.CALCulate.PN(1-1).TRACe(1-1).BDMarker.Y.SPAN . . . . .	139
SCPI.CALCulate.PN(1-1).TRACe(1-1).BDMarker.Y.STARt . . . . .	139



SCPI.CALCulate.PN(1-1).TRACe(1-1).BDMarker.Y.STATe . . . . . 140

SCPI.CALCulate.PN(1-1).TRACe(1-1).BDMarker.Y.STOP . . . . . 140

SCPI.CALCulate.PN(1-1).TRACe(1-1).DATA.COPY . . . . . 141

SCPI.CALCulate.PN(1-1).TRACe(1-1).DATA.FDATA . . . . . 141

SCPI.CALCulate.PN(1-1).TRACe(1-1).DATA.FMEMory . . . . . 142

SCPI.CALCulate.PN(1-1).TRACe(1-1).DATA.PDATA . . . . . 142

SCPI.CALCulate.PN(1-1).TRACe(1-1).DATA.PMEMory . . . . . 143

SCPI.CALCulate.PN(1-1).TRACe(1-1).DATA.SDATA . . . . . 143

SCPI.CALCulate.PN(1-1).TRACe(1-1).DATA.SMEMory . . . . . 143

SCPI.CALCulate.PN(1-1).TRACe(1-1).DATA.UDATA . . . . . 143

SCPI.CALCulate.PN(1-1).TRACe(1-1).DATA.UMEMory . . . . . 144

SCPI.CALCulate.PN(1-1).TRACe(1-1).FUNCTion.DOMain.X . . . . . 144

SCPI.CALCulate.PN(1-1).TRACe(1-1).FUNCTion.DOMain.Y . . . . . 145

SCPI.CALCulate.PN(1-1).TRACe(1-1).FUNCTion.INTegral.DATA\_Q integ\_noise, freq\_range, rms\_rad,  
rms\_deg, jitter, residual\_fm . . . . . 145

SCPI.CALCulate.PN(1-1).TRACe(1-1).FUNCTion.INTegral.MEMory\_Q integ\_noise, freq\_range,  
rms\_rad, rms\_deg, jitter, residual\_fm . . . . . 145

SCPI.CALCulate.PN(1-1).TRACe(1-1).FUNCTion.STATistics.DATA\_Q . . . . . 145

SCPI.CALCulate.PN(1-1).TRACe(1-1).FUNCTion.STATistics.MEMory\_Q . . . . . 146

SCPI.CALCulate.PN(1-1).TRACe(1-1).FUNCTion.TYPE . . . . . 146

SCPI.CALCulate.PN(1-1).TRACe(1-1).HOLD . . . . . 146

SCPI.CALCulate.PN(1-1).TRACe(1-1).LIMit.FAIL . . . . . 147

SCPI.CALCulate.PN(1-1).TRACe(1-1).LIMit.LOWer.LDATA . . . . . 147

SCPI.CALCulate.PN(1-1).TRACe(1-1).LIMit.LOWer.SEGMent.CLEAr . . . . . 148

SCPI.CALCulate.PN(1-1).TRACe(1-1).LIMit.LOWer.SEGMent.COUNt . . . . . 148

SCPI.CALCulate.PN(1-1).TRACe(1-1).LIMit.LOWer.SEGMent.DATA . . . . . 148

SCPI.CALCulate.PN(1-1).TRACe(1-1).LIMit.REPort.DATA . . . . . 149

SCPI.CALCulate.PN(1-1).TRACe(1-1).LIMit.STATe . . . . . 149

SCPI.CALCulate.PN(1-1).TRACe(1-1).LIMit.UPPer.LDATA . . . . . 149

SCPI.CALCulate.PN(1-1).TRACe(1-1).LIMit.UPPer.SEGMent.CLEAr . . . . . 150

SCPI.CALCulate.PN(1-1).TRACe(1-1).LIMit.UPPer.SEGMent.COUNt . . . . . 150

SCPI.CALCulate.PN(1-1).TRACe(1-1).LIMit.UPPer.SEGMent.DATA . . . . . 150

SCPI.CALCulate.PN(1-1).TRACe(1-1).MARKer(1-6).SEARch.EXECute.LPEAk . . . . . 151

SCPI.CALCulate.PN(1-1).TRACe(1-1).MARKer(1-6).SEARch.EXECute.LTARget . . . . . 151

SCPI.CALCulate.PN(1-1).TRACe(1-1).MARKer(1-6).SEARch.EXECute.MAXimum . . . . . 151

SCPI.CALCulate.PN(1-1).TRACe(1-1).MARKer(1-6).SEARch.EXECute.MINimum . . . . . 151

SCPI.CALCulate.PN(1-1).TRACe(1-1).MARKer(1-6).SEARch.EXECute.PEAK . . . . . 152

SCPI.CALCulate.PN(1-1).TRACe(1-1).MARKer(1-6).SEARch.EXECute.RPEAk . . . . . 152

SCPI.CALCulate.PN(1-1).TRACe(1-1).MARKer(1-6).SEARch.EXECute.RTARget . . . . . 152

SCPI.CALCulate.PN(1-1).TRACe(1-1).MARKer(1-6).SEARch.EXECute.TARGet . . . . . 152

SCPI.CALCulate.PN(1-1).TRACe(1-1).MARKer(1-6).SEARch.PEAK.EXCURsion . . . . . 152

SCPI.CALCulate.PN(1-1).TRACe(1-1).MARKer(1-6).SEARch.PEAK.POLarity . . . . . 153

SCPI.CALCulate.PN(1-1).TRACe(1-1).MARKer(1-6).SEARch.TARGet.TRANSition . . . . . 153

SCPI.CALCulate.PN(1-1).TRACe(1-1).MARKer(1-6).SEARch.TARGet.Y . . . . . 154

SCPI.CALCulate.PN(1-1).TRACe(1-1).MARKer(1-6).SEARch.TRACking.TYPE . . . . . 154

SCPI.CALCulate.PN(1-1).TRACe(1-1).MARKer(1-6).STATe . . . . . 155

SCPI.CALCulate.PN(1-1).TRACe(1-1).MARKer(1-6).X . . . . . 155

SCPI.CALCulate.PN(1-1).TRACe(1-1).MARKer(1-6).Y . . . . . 156

SCPI.CALCulate.PN(1-1).TRACe(1-1).MATH.FUNCTion . . . . . 156

SCPI.CALCulate.PN(1-1).TRACe(1-1).MATH.MEMorize . . . . .	156
SCPI.CALCulate.PN(1-1).TRACe(1-1).SMOothing.APERture . . . . .	156
SCPI.CALCulate.PN(1-1).TRACe(1-1).SMOothing.STATe . . . . .	157
SCPI.CALCulate.PN(1-1).TRACe(1-1).SPURious.OMISsion . . . . .	157
SCPI.CALCulate.PN(1-1).TRACe(1-1).SPURious.POWER. . . . .	158
SCPI.CALCulate.PN(1-1).TRACe(1-1).SPURious.THReshold.TABLE.CLEar . . . . .	158
SCPI.CALCulate.PN(1-1).TRACe(1-1).SPURious.THReshold.TABLE.COUNT . . . . .	158
SCPI.CALCulate.PN(1-1).TRACe(1-1).SPURious.THReshold.TABLE.DATA . . . . .	159
SCPI.CALCulate.SP(1-1).ALLTrace.LIMit.FAIL . . . . .	159
SCPI.CALCulate.SP(1-1).ALLTrace.MARKer.COUPle.STATe . . . . .	159
SCPI.CALCulate.SP(1-1).ALLTrace.MARKer.DISCrete.STATe . . . . .	160
SCPI.CALCulate.SP(1-1).ALLTrace.MARKer.REFerence.NUMBer . . . . .	160
SCPI.CALCulate.SP(1-1).ALLTrace.MARKer.REFerence.STATe . . . . .	161
SCPI.CALCulate.SP(1-1).DATA.RDATA. . . . .	161
SCPI.CALCulate.SP(1-1).DATA.XDATA. . . . .	161
SCPI.CALCulate.SP(1-1).TRACe(1-1).ALLMarker.ACTive . . . . .	162
SCPI.CALCulate.SP(1-1).TRACe(1-1).ALLMarker.SEARch.DOMain.X . . . . .	162
SCPI.CALCulate.SP(1-1).TRACe(1-1).ALLMarker.SEARch.DOMain.Y . . . . .	162
SCPI.CALCulate.SP(1-1).TRACe(1-1).ALLMarker.SEARch.PEAK . . . . .	163
SCPI.CALCulate.SP(1-1).TRACe(1-1).BDMarker.X.CENTER . . . . .	163
SCPI.CALCulate.SP(1-1).TRACe(1-1).BDMarker.X.SPAN . . . . .	163
SCPI.CALCulate.SP(1-1).TRACe(1-1).BDMarker.X.START . . . . .	164
SCPI.CALCulate.SP(1-1).TRACe(1-1).BDMarker.X.STATe . . . . .	164
SCPI.CALCulate.SP(1-1).TRACe(1-1).BDMarker.X.STOP . . . . .	165
SCPI.CALCulate.SP(1-1).TRACe(1-1).BDMarker.Y.CENTER . . . . .	165
SCPI.CALCulate.SP(1-1).TRACe(1-1).BDMarker.Y.SPAN . . . . .	166
SCPI.CALCulate.SP(1-1).TRACe(1-1).BDMarker.Y.START . . . . .	166
SCPI.CALCulate.SP(1-1).TRACe(1-1).BDMarker.Y.STATe . . . . .	167
SCPI.CALCulate.SP(1-1).TRACe(1-1).BDMarker.Y.STOP . . . . .	167
SCPI.CALCulate.SP(1-1).TRACe(1-1).DATA.COPY. . . . .	167
SCPI.CALCulate.SP(1-1).TRACe(1-1).DATA.FDATA . . . . .	168
SCPI.CALCulate.SP(1-1).TRACe(1-1).DATA.FMEMory . . . . .	168
SCPI.CALCulate.SP(1-1).TRACe(1-1).DATA.UDATA . . . . .	169
SCPI.CALCulate.SP(1-1).TRACe(1-1).DATA.UMEMory . . . . .	169
SCPI.CALCulate.SP(1-1).TRACe(1-1).FORMat . . . . .	170
SCPI.CALCulate.SP(1-1).TRACe(1-1).FUNCTion.DOMain.X . . . . .	170
SCPI.CALCulate.SP(1-1).TRACe(1-1).FUNCTion.DOMain.Y . . . . .	171
SCPI.CALCulate.SP(1-1).TRACe(1-1).FUNCTion.STATistics.DATA_Q . . . . .	171
SCPI.CALCulate.SP(1-1).TRACe(1-1).FUNCTion.STATistics.MEMory_Q . . . . .	171
SCPI.CALCulate.SP(1-1).TRACe(1-1).FUNCTion.TYPE. . . . .	172
SCPI.CALCulate.SP(1-1).TRACe(1-1).HOLD . . . . .	172
SCPI.CALCulate.SP(1-1).TRACe(1-1).LIMit.FAIL . . . . .	172
SCPI.CALCulate.SP(1-1).TRACe(1-1).LIMit.LOWer.LDATA . . . . .	173
SCPI.CALCulate.SP(1-1).TRACe(1-1).LIMit.LOWer.SEGment.CLEar . . . . .	173
SCPI.CALCulate.SP(1-1).TRACe(1-1).LIMit.LOWer.SEGment.COUNT . . . . .	173
SCPI.CALCulate.SP(1-1).TRACe(1-1).LIMit.LOWer.SEGment.DATA . . . . .	174
SCPI.CALCulate.SP(1-1).TRACe(1-1).LIMit.REPort.DATA . . . . .	174
SCPI.CALCulate.SP(1-1).TRACe(1-1).LIMit.STATe . . . . .	174
SCPI.CALCulate.SP(1-1).TRACe(1-1).LIMit.UPPer.LDATA . . . . .	175

SCPI.CALCulate.SP(1-1).TRACe(1-1).LIMit.UPPer.SEGMent.CLEAr . . . . .	175
SCPI.CALCulate.SP(1-1).TRACe(1-1).LIMit.UPPer.SEGMent.COUNT . . . . .	175
SCPI.CALCulate.SP(1-1).TRACe(1-1).LIMit.UPPer.SEGMent.DATA . . . . .	176
SCPI.CALCulate.SP(1-1).TRACe(1-1).MARKer(1-6).SEARCh.EXECute.LPEak . . . . .	176
SCPI.CALCulate.SP(1-1).TRACe(1-1).MARKer(1-6).SEARCh.EXECute.LTARget . . . . .	176
SCPI.CALCulate.SP(1-1).TRACe(1-1).MARKer(1-6).SEARCh.EXECute.MAXimum . . . . .	177
SCPI.CALCulate.SP(1-1).TRACe(1-1).MARKer(1-6).SEARCh.EXECute.MINimum . . . . .	177
SCPI.CALCulate.SP(1-1).TRACe(1-1).MARKer(1-6).SEARCh.EXECute.PEAK . . . . .	177
SCPI.CALCulate.SP(1-1).TRACe(1-1).MARKer(1-6).SEARCh.EXECute.RPEak . . . . .	177
SCPI.CALCulate.SP(1-1).TRACe(1-1).MARKer(1-6).SEARCh.EXECute.RTARget . . . . .	177
SCPI.CALCulate.SP(1-1).TRACe(1-1).MARKer(1-6).SEARCh.EXECute.TARGet . . . . .	178
SCPI.CALCulate.SP(1-1).TRACe(1-1).MARKer(1-6).SEARCh.PEAK.EXCursion . . . . .	178
SCPI.CALCulate.SP(1-1).TRACe(1-1).MARKer(1-6).SEARCh.PEAK.POLarity . . . . .	178
SCPI.CALCulate.SP(1-1).TRACe(1-1).MARKer(1-6).SEARCh.TARGet.TRANSition . . . . .	179
SCPI.CALCulate.SP(1-1).TRACe(1-1).MARKer(1-6).SEARCh.TARGet.Y . . . . .	179
SCPI.CALCulate.SP(1-1).TRACe(1-1).MARKer(1-6).SEARCh.TRACking.TYPE . . . . .	180
SCPI.CALCulate.SP(1-1).TRACe(1-1).MARKer(1-6).STATE . . . . .	180
SCPI.CALCulate.SP(1-1).TRACe(1-1).MARKer(1-6).X . . . . .	180
SCPI.CALCulate.SP(1-1).TRACe(1-1).MARKer(1-6).Y . . . . .	181
SCPI.CALCulate.SP(1-1).TRACe(1-1).MATH.FUNCTION . . . . .	181
SCPI.CALCulate.SP(1-1).TRACe(1-1).MATH.MEMorize . . . . .	181
SCPI.CALCulate.SP(1-1).TRACe(1-1).SMOothing.APERture . . . . .	182
SCPI.CALCulate.SP(1-1).TRACe(1-1).SMOothing.STATE . . . . .	182
SCPI.CALCulate.TR(1-1).ALLTrace.ACTive . . . . .	182
SCPI.CALCulate.TR(1-1).ALLTrace.BDMarker.X.COUPle.STATE . . . . .	183
SCPI.CALCulate.TR(1-1).ALLTrace.LIMit.FAIL . . . . .	183
SCPI.CALCulate.TR(1-1).ALLTrace.MARKer.COUPle.STATE . . . . .	184
SCPI.CALCulate.TR(1-1).ALLTrace.MARKer.DISCrete.STATE . . . . .	184
SCPI.CALCulate.TR(1-1).ALLTrace.MARKer.REFerence.NUMBer . . . . .	184
SCPI.CALCulate.TR(1-1).ALLTrace.MARKer.REFerence.STATE . . . . .	185
SCPI.CALCulate.TR(1-1).NARRow.DATA.RDATA . . . . .	185
SCPI.CALCulate.TR(1-1).NARRow.DATA.XDATA . . . . .	186
SCPI.CALCulate.TR(1-1).TRACe(1-4).ALLMarker.ACTive . . . . .	186
SCPI.CALCulate.TR(1-1).TRACe(1-4).ALLMarker.SEARCh.DOMain.X . . . . .	186
SCPI.CALCulate.TR(1-1).TRACe(1-4).ALLMarker.SEARCh.DOMain.Y . . . . .	187
SCPI.CALCulate.TR(1-1).TRACe(1-4).ALLMarker.SEARCh.PEAK . . . . .	187
SCPI.CALCulate.TR(1-1).TRACe(1-4).BDMarker.X.CENTer . . . . .	187
SCPI.CALCulate.TR(1-1).TRACe(1-4).BDMarker.X.SPAN . . . . .	188
SCPI.CALCulate.TR(1-1).TRACe(1-4).BDMarker.X.STARt . . . . .	188
SCPI.CALCulate.TR(1-1).TRACe(1-4).BDMarker.X.STATE . . . . .	188
SCPI.CALCulate.TR(1-1).TRACe(1-4).BDMarker.X.STOP . . . . .	189
SCPI.CALCulate.TR(1-1).TRACe(1-4).BDMarker.Y.CENTer . . . . .	189
SCPI.CALCulate.TR(1-1).TRACe(1-4).BDMarker.Y.SPAN . . . . .	190
SCPI.CALCulate.TR(1-1).TRACe(1-4).BDMarker.Y.STARt . . . . .	190
SCPI.CALCulate.TR(1-1).TRACe(1-4).BDMarker.Y.STATE . . . . .	191
SCPI.CALCulate.TR(1-1).TRACe(1-4).BDMarker.Y.STOP . . . . .	191
SCPI.CALCulate.TR(1-1).TRACe(1-4).DATA.COPY . . . . .	191
SCPI.CALCulate.TR(1-1).TRACe(1-4).DATA.FDATA . . . . .	192
SCPI.CALCulate.TR(1-1).TRACe(1-4).DATA.FMEMORY . . . . .	192

SCPI.CALCulate.TR(1-1).TRACe(1-4).DATA.UDATa . . . . .	193
SCPI.CALCulate.TR(1-1).TRACe(1-4).DATA.UMEMory . . . . .	193
SCPI.CALCulate.TR(1-1).TRACe(1-4).FORMat.FREQuency . . . . .	194
SCPI.CALCulate.TR(1-1).TRACe(1-4).FORMat.PHASE.PREFeRence.OFFSet . . . . .	194
SCPI.CALCulate.TR(1-1).TRACe(1-4).FORMat.PHASE.UNIT . . . . .	195
SCPI.CALCulate.TR(1-1).TRACe(1-4).FORMat.PHASE.WRAP . . . . .	195
SCPI.CALCulate.TR(1-1).TRACe(1-4).FUNctioN.DOMain.X . . . . .	195
SCPI.CALCulate.TR(1-1).TRACe(1-4).FUNctioN.DOMain.Y . . . . .	196
SCPI.CALCulate.TR(1-1).TRACe(1-4).FUNctioN.STATistics.DATA_Q . . . . .	196
SCPI.CALCulate.TR(1-1).TRACe(1-4).FUNctioN.STATistics.MEMory_Q . . . . .	196
SCPI.CALCulate.TR(1-1).TRACe(1-4).FUNctioN.TYPE . . . . .	197
SCPI.CALCulate.TR(1-1).TRACe(1-4).HOLD . . . . .	197
SCPI.CALCulate.TR(1-1).TRACe(1-4).LIMit.FAIL . . . . .	198
SCPI.CALCulate.TR(1-1).TRACe(1-4).LIMit.LOWer.LDATa . . . . .	198
SCPI.CALCulate.TR(1-1).TRACe(1-4).LIMit.LOWer.SEGment.CLEar . . . . .	198
SCPI.CALCulate.TR(1-1).TRACe(1-4).LIMit.LOWer.SEGment.COUNT . . . . .	199
SCPI.CALCulate.TR(1-1).TRACe(1-4).LIMit.LOWer.SEGment.DATA . . . . .	199
SCPI.CALCulate.TR(1-1).TRACe(1-4).LIMit.REPort.DATA . . . . .	199
SCPI.CALCulate.TR(1-1).TRACe(1-4).LIMit.STATe . . . . .	200
SCPI.CALCulate.TR(1-1).TRACe(1-4).LIMit.UPPer.LDATa . . . . .	200
SCPI.CALCulate.TR(1-1).TRACe(1-4).LIMit.UPPer.SEGment.CLEar . . . . .	200
SCPI.CALCulate.TR(1-1).TRACe(1-4).LIMit.UPPer.SEGment.COUNT . . . . .	201
SCPI.CALCulate.TR(1-1).TRACe(1-4).LIMit.UPPer.SEGment.DATA . . . . .	201
SCPI.CALCulate.TR(1-1).TRACe(1-4).MARKer(1-6).SEARch.EXECute.LPEak . . . . .	201
SCPI.CALCulate.TR(1-1).TRACe(1-4).MARKer(1-6).SEARch.EXECute.LTARget . . . . .	202
SCPI.CALCulate.TR(1-1).TRACe(1-4).MARKer(1-6).SEARch.EXECute.MAXimum . . . . .	202
SCPI.CALCulate.TR(1-1).TRACe(1-4).MARKer(1-6).SEARch.EXECute.MINimum . . . . .	202
SCPI.CALCulate.TR(1-1).TRACe(1-4).MARKer(1-6).SEARch.EXECute.PEAK . . . . .	202
SCPI.CALCulate.TR(1-1).TRACe(1-4).MARKer(1-6).SEARch.EXECute.RPEak . . . . .	202
SCPI.CALCulate.TR(1-1).TRACe(1-4).MARKer(1-6).SEARch.EXECute.RTARget . . . . .	203
SCPI.CALCulate.TR(1-1).TRACe(1-4).MARKer(1-6).SEARch.EXECute.TARGet . . . . .	203
SCPI.CALCulate.TR(1-1).TRACe(1-4).MARKer(1-6).SEARch.PEAK.EXCursion . . . . .	203
SCPI.CALCulate.TR(1-1).TRACe(1-4).MARKer(1-6).SEARch.PEAK.POLarity . . . . .	203
SCPI.CALCulate.TR(1-1).TRACe(1-4).MARKer(1-6).SEARch.TARGet.TRANsition . . . . .	204
SCPI.CALCulate.TR(1-1).TRACe(1-4).MARKer(1-6).SEARch.TARGet.Y . . . . .	204
SCPI.CALCulate.TR(1-1).TRACe(1-4).MARKer(1-6).SEARch.TRACKing.TYPE . . . . .	205
SCPI.CALCulate.TR(1-1).TRACe(1-4).MARKer(1-6).STATe . . . . .	205
SCPI.CALCulate.TR(1-1).TRACe(1-4).MARKer(1-6).X . . . . .	206
SCPI.CALCulate.TR(1-1).TRACe(1-4).MARKer(1-6).Y . . . . .	206
SCPI.CALCulate.TR(1-1).TRACe(1-4).MATH.FUNctioN . . . . .	206
SCPI.CALCulate.TR(1-1).TRACe(1-4).MATH.MEMorize . . . . .	207
SCPI.CALCulate.TR(1-1).TRACe(1-4).PARAmeter . . . . .	207
SCPI.CALCulate.TR(1-1).TRACe(1-4).REFerence.FREQuency . . . . .	207
SCPI.CALCulate.TR(1-1).TRACe(1-4).SMOothing.APERture . . . . .	208
SCPI.CALCulate.TR(1-1).TRACe(1-4).SMOothing.STATe . . . . .	208
SCPI.CALCulate.TR(1-1).WIDE.DATA.RDATa . . . . .	208
SCPI.CALCulate.TR(1-1).WIDE.DATA.XDATa . . . . .	209
SCPI.CALCulate.USER(1-1).ALLTrace.ACTive . . . . .	209
SCPI.CALCulate.USER(1-1).ALLTrace.BDMarker.X.COUPle.STATe . . . . .	209

SCPI.CALCulate.USER(1-1).ALLTrace.LIMit.FAIL . . . . . 210

SCPI.CALCulate.USER(1-1).ALLTrace.MARKer.COUPle.STATe . . . . . 210

SCPI.CALCulate.USER(1-1).ALLTrace.MARKer.DISCrete.STATe. . . . . 211

SCPI.CALCulate.USER(1-1).ALLTrace.MARKer.REFerence.NUMBer . . . . . 211

SCPI.CALCulate.USER(1-1).ALLTrace.MARKer.REFerence.STATe . . . . . 211

SCPI.CALCulate.USER(1-1).TRACe(1-8).ALLMarker.ACTive . . . . . 212

SCPI.CALCulate.USER(1-1).TRACe(1-8).ALLMarker.SEARch.DOMain.X . . . . . 212

SCPI.CALCulate.USER(1-1).TRACe(1-8).ALLMarker.SEARch.DOMain.Y . . . . . 213

SCPI.CALCulate.USER(1-1).TRACe(1-8).ALLMarker.SEARch.PEAK . . . . . 213

SCPI.CALCulate.USER(1-1).TRACe(1-8).BDMarker.X.CENTer . . . . . 213

SCPI.CALCulate.USER(1-1).TRACe(1-8).BDMarker.X.SPAN . . . . . 214

SCPI.CALCulate.USER(1-1).TRACe(1-8).BDMarker.X.STARt . . . . . 214

SCPI.CALCulate.USER(1-1).TRACe(1-8).BDMarker.X.STATe. . . . . 215

SCPI.CALCulate.USER(1-1).TRACe(1-8).BDMarker.X.STOP . . . . . 215

SCPI.CALCulate.USER(1-1).TRACe(1-8).BDMarker.Y.CENTer. . . . . 216

SCPI.CALCulate.USER(1-1).TRACe(1-8).BDMarker.Y.SPAN . . . . . 216

SCPI.CALCulate.USER(1-1).TRACe(1-8).BDMarker.Y.STARt. . . . . 217

SCPI.CALCulate.USER(1-1).TRACe(1-8).BDMarker.Y.STATe. . . . . 217

SCPI.CALCulate.USER(1-1).TRACe(1-8).BDMarker.Y.STOP . . . . . 217

SCPI.CALCulate.USER(1-1).TRACe(1-8).DATA.COPY . . . . . 218

SCPI.CALCulate.USER(1-1).TRACe(1-8).DATA.FDATa . . . . . 218

SCPI.CALCulate.USER(1-1).TRACe(1-8).DATA.FMEMory . . . . . 219

SCPI.CALCulate.USER(1-1).TRACe(1-8).DATA.POINts . . . . . 219

SCPI.CALCulate.USER(1-1).TRACe(1-8).DATA.RDATa . . . . . 219

SCPI.CALCulate.USER(1-1).TRACe(1-8).DATA.STARt. . . . . 220

SCPI.CALCulate.USER(1-1).TRACe(1-8).DATA.STOP . . . . . 220

SCPI.CALCulate.USER(1-1).TRACe(1-8).DATA.UDATa . . . . . 220

SCPI.CALCulate.USER(1-1).TRACe(1-8).DATA.UMEMory . . . . . 221

SCPI.CALCulate.USER(1-1).TRACe(1-8).DATA.XDATa . . . . . 221

SCPI.CALCulate.USER(1-1).TRACe(1-8).FUNCTion.DOMain.X . . . . . 221

SCPI.CALCulate.USER(1-1).TRACe(1-8).FUNCTion.DOMain.Y . . . . . 222

SCPI.CALCulate.USER(1-1).TRACe(1-8).FUNCTion.STATistics.DATA\_Q . . . . . 222

SCPI.CALCulate.USER(1-1).TRACe(1-8).FUNCTion.STATistics.MEMory\_Q . . . . . 223

SCPI.CALCulate.USER(1-1).TRACe(1-8).FUNCTion.TYPE . . . . . 223

SCPI.CALCulate.USER(1-1).TRACe(1-8).HOLD . . . . . 223

SCPI.CALCulate.USER(1-1).TRACe(1-8).LIMit.FAIL . . . . . 224

SCPI.CALCulate.USER(1-1).TRACe(1-8).LIMit.LOWer.LDATa . . . . . 224

SCPI.CALCulate.USER(1-1).TRACe(1-8).LIMit.LOWer.SEGMent.CLEAr . . . . . 224

SCPI.CALCulate.USER(1-1).TRACe(1-8).LIMit.LOWer.SEGMent.COUNT. . . . . 225

SCPI.CALCulate.USER(1-1).TRACe(1-8).LIMit.LOWer.SEGMent.DATA. . . . . 225

SCPI.CALCulate.USER(1-1).TRACe(1-8).LIMit.REPort.DATA . . . . . 225

SCPI.CALCulate.USER(1-1).TRACe(1-8).LIMit.STATe . . . . . 226

SCPI.CALCulate.USER(1-1).TRACe(1-8).LIMit.UPPer.LDATa . . . . . 226

SCPI.CALCulate.USER(1-1).TRACe(1-8).LIMit.UPPer.SEGMent.CLEAr . . . . . 226

SCPI.CALCulate.USER(1-1).TRACe(1-8).LIMit.UPPer.SEGMent.COUNT . . . . . 227

SCPI.CALCulate.USER(1-1).TRACe(1-8).LIMit.UPPer.SEGMent.DATA . . . . . 227

SCPI.CALCulate.USER(1-1).TRACe(1-8).MARKer(1-6).SEARch.EXECute.LPEAk . . . . . 227

SCPI.CALCulate.USER(1-1).TRACe(1-8).MARKer(1-6).SEARch.EXECute.LTARget . . . . . 228

SCPI.CALCulate.USER(1-1).TRACe(1-8).MARKer(1-6).SEARch.EXECute.MAXimum . . . . . 228

SCPI.CALCulate.USER(1-1).TRACe(1-8).MARKer(1-6).SEARch.EXECute.MINimum	228
SCPI.CALCulate.USER(1-1).TRACe(1-8).MARKer(1-6).SEARch.EXECute.PEAK	228
SCPI.CALCulate.USER(1-1).TRACe(1-8).MARKer(1-6).SEARch.EXECute.RPEak	228
SCPI.CALCulate.USER(1-1).TRACe(1-8).MARKer(1-6).SEARch.EXECute.RTARget	229
SCPI.CALCulate.USER(1-1).TRACe(1-8).MARKer(1-6).SEARch.EXECute.TARGet	229
SCPI.CALCulate.USER(1-1).TRACe(1-8).MARKer(1-6).SEARch.PEAK.EXCursion	229
SCPI.CALCulate.USER(1-1).TRACe(1-8).MARKer(1-6).SEARch.PEAK.POLarity	229
SCPI.CALCulate.USER(1-1).TRACe(1-8).MARKer(1-6).SEARch.TARGet.TRANSition	230
SCPI.CALCulate.USER(1-1).TRACe(1-8).MARKer(1-6).SEARch.TARGet.Y	230
SCPI.CALCulate.USER(1-1).TRACe(1-8).MARKer(1-6).SEARch.TRACKing.TYPE	231
SCPI.CALCulate.USER(1-1).TRACe(1-8).MARKer(1-6).STATe	231
SCPI.CALCulate.USER(1-1).TRACe(1-8).MARKer(1-6).X	232
SCPI.CALCulate.USER(1-1).TRACe(1-8).MARKer(1-6).Y	232
SCPI.CALCulate.USER(1-1).TRACe(1-8).MATH.FUNCTion	232
SCPI.CALCulate.USER(1-1).TRACe(1-8).MATH.MEMorize	233
SCPI.CALCulate.USER(1-1).TRACe(1-8).SMOothing.APERture	233
SCPI.CALCulate.USER(1-1).TRACe(1-8).SMOothing.STATe	234
SCPI.CONTRol.HANDler.A.DATA	234
SCPI.CONTRol.HANDler.B.DATA	234
SCPI.CONTRol.HANDler.C.DATA	235
SCPI.CONTRol.HANDler.C.MODE	235
SCPI.CONTRol.HANDler.D.DATA	236
SCPI.CONTRol.HANDler.D.MODE	236
SCPI.CONTRol.HANDler.E.DATA	236
SCPI.CONTRol.HANDler.F.DATA	237
SCPI.CONTRol.HANDler.OUTPut(1-2).DATA	237
SCPI.DISPlay.CLOCK	238
SCPI.DISPlay.ECHO.ADD	238
SCPI.DISPlay.ECHO.CLEar	238
SCPI.DISPlay.ECHO.DATA	239
SCPI.DISPlay.ECHO.FSIZE	239
SCPI.DISPlay.ECHO.STATe	240
SCPI.DISPlay.ENABLE	240
SCPI.DISPlay.FP(1-1).ALLTrace.PERSistence.CLEar	241
SCPI.DISPlay.FP(1-1).ALLTrace.Y.SCALE.AUTO	241
SCPI.DISPlay.FP(1-1).ANNotation.MARKer.POSition	241
SCPI.DISPlay.FP(1-1).ANNotation.MEASurement.STATe	241
SCPI.DISPlay.FP(1-1).GRATicule.AXIS.Y.RELative	242
SCPI.DISPlay.FP(1-1).GRATicule.AXIS.Y.STATe	242
SCPI.DISPlay.FP(1-1).LABel.DATA	242
SCPI.DISPlay.FP(1-1).LABel.STATe	243
SCPI.DISPlay.FP(1-1).LIMit.FSIGn	243
SCPI.DISPlay.FP(1-1).MAXimize	244
SCPI.DISPlay.FP(1-1).SPLit	244
SCPI.DISPlay.FP(1-1).STATe	244
SCPI.DISPlay.FP(1-1).TABLe.STATe	245
SCPI.DISPlay.FP(1-1).TRACe(1-4).LABel.DATA	245
SCPI.DISPlay.FP(1-1).TRACe(1-4).LIMit.LINE	246
SCPI.DISPlay.FP(1-1).TRACe(1-4).MODE	246

SCPI.DISPlay.FP(1-1).TRACe(1-4).PERSistence.CLEAr . . . . .	246
SCPI.DISPlay.FP(1-1).TRACe(1-4).PERSistence.STATe . . . . .	247
SCPI.DISPlay.FP(1-1).TRACe(1-4).Y.SCALe.AUTO . . . . .	247
SCPI.DISPlay.FP(1-1).TRACe(1-4).Y.SCALe.PDIVision . . . . .	247
SCPI.DISPlay.FP(1-1).TRACe(1-4).Y.SCALe.RLEVel . . . . .	247
SCPI.DISPlay.FP(1-1).TRACe(1-4).Y.SCALe.RPOStion . . . . .	248
SCPI.DISPlay.FP(1-1).Y.SCALe.DIVisions . . . . .	248
SCPI.DISPlay.MAXimize . . . . .	249
SCPI.DISPlay.MESSage.CLEAr . . . . .	249
SCPI.DISPlay.PN(1-1).ALLTrace.PERSistence.CLEAr . . . . .	249
SCPI.DISPlay.PN(1-1).ANNotation.MARKer.POSition . . . . .	250
SCPI.DISPlay.PN(1-1).ANNotation.MEASurement.STATe . . . . .	250
SCPI.DISPlay.PN(1-1).GRATicule.AXIS.Y.RELative . . . . .	250
SCPI.DISPlay.PN(1-1).GRATicule.AXIS.Y.STATe . . . . .	251
SCPI.DISPlay.PN(1-1).LABel.DATA . . . . .	251
SCPI.DISPlay.PN(1-1).LABel.STATe . . . . .	252
SCPI.DISPlay.PN(1-1).LIMit.FSIGn . . . . .	252
SCPI.DISPlay.PN(1-1).MAXimize . . . . .	252
SCPI.DISPlay.PN(1-1).STATe . . . . .	253
SCPI.DISPlay.PN(1-1).TABLe.STATe . . . . .	253
SCPI.DISPlay.PN(1-1).TRACe(1-1).LABel.DATA . . . . .	254
SCPI.DISPlay.PN(1-1).TRACe(1-1).LIMit.LINE . . . . .	254
SCPI.DISPlay.PN(1-1).TRACe(1-1).MODE . . . . .	254
SCPI.DISPlay.PN(1-1).TRACe(1-1).PERSistence.CLEAr . . . . .	255
SCPI.DISPlay.PN(1-1).TRACe(1-1).PERSistence.STATe . . . . .	255
SCPI.DISPlay.PN(1-1).TRACe(1-1).Y.SCALe.AUTO . . . . .	255
SCPI.DISPlay.PN(1-1).TRACe(1-1).Y.SCALe.PDIVision . . . . .	256
SCPI.DISPlay.PN(1-1).TRACe(1-1).Y.SCALe.RLEVel . . . . .	256
SCPI.DISPlay.PN(1-1).TRACe(1-1).Y.SCALe.RPOStion . . . . .	256
SCPI.DISPlay.PN(1-1).Y.SCALe.DIVisions . . . . .	257
SCPI.DISPlay.SKEY.STATe . . . . .	257
SCPI.DISPlay.SP(1-1).ALLTrace.PERSistence.CLEAr . . . . .	258
SCPI.DISPlay.SP(1-1).ANNotation.MARKer.POSition . . . . .	258
SCPI.DISPlay.SP(1-1).ANNotation.MEASurement.STATe . . . . .	258
SCPI.DISPlay.SP(1-1).GRATicule.AXIS.Y.RELative . . . . .	258
SCPI.DISPlay.SP(1-1).GRATicule.AXIS.Y.STATe . . . . .	259
SCPI.DISPlay.SP(1-1).LABel.DATA . . . . .	259
SCPI.DISPlay.SP(1-1).LABel.STATe . . . . .	260
SCPI.DISPlay.SP(1-1).LIMit.FSIGn . . . . .	260
SCPI.DISPlay.SP(1-1).MAXimize . . . . .	260
SCPI.DISPlay.SP(1-1).STATe . . . . .	261
SCPI.DISPlay.SP(1-1).TABLe.STATe . . . . .	261
SCPI.DISPlay.SP(1-1).TRACe(1-1).LABel.DATA . . . . .	262
SCPI.DISPlay.SP(1-1).TRACe(1-1).LIMit.LINE . . . . .	262
SCPI.DISPlay.SP(1-1).TRACe(1-1).MODE . . . . .	262
SCPI.DISPlay.SP(1-1).TRACe(1-1).PERSistence.CLEAr . . . . .	263
SCPI.DISPlay.SP(1-1).TRACe(1-1).PERSistence.STATe . . . . .	263
SCPI.DISPlay.SP(1-1).TRACe(1-1).Y.SCALe.AUTO . . . . .	263
SCPI.DISPlay.SP(1-1).TRACe(1-1).Y.SCALe.PDIVision . . . . .	264

---

## Contents

SCPI.DISPlay.SP(1-1).TRACe(1-1).Y.SCALe.RLEVel . . . . .	264
SCPI.DISPlay.SP(1-1).TRACe(1-1).Y.SCALe.RPOSITION . . . . .	264
SCPI.DISPlay.SP(1-1).Y.SCALe.DIVisions . . . . .	265
SCPI.DISPlay.TR(1-1).ALLTrace.PERSistence.CLEAr . . . . .	265
SCPI.DISPlay.TR(1-1).ALLTrace.Y.SCALe.AUTO . . . . .	265
SCPI.DISPlay.TR(1-1).ANNotation.MARKer.POSition . . . . .	266
SCPI.DISPlay.TR(1-1).ANNotation.MEASurement.STATe . . . . .	266
SCPI.DISPlay.TR(1-1).GRATicule.AXIS.Y.RELative . . . . .	266
SCPI.DISPlay.TR(1-1).GRATicule.AXIS.Y.STATe . . . . .	267
SCPI.DISPlay.TR(1-1).LABel.DATA . . . . .	267
SCPI.DISPlay.TR(1-1).LABel.STATe . . . . .	268
SCPI.DISPlay.TR(1-1).LIMit.FSIGn . . . . .	268
SCPI.DISPlay.TR(1-1).MAXimize . . . . .	268
SCPI.DISPlay.TR(1-1).STATe . . . . .	269
SCPI.DISPlay.TR(1-1).TABLe.STATe . . . . .	269
SCPI.DISPlay.TR(1-1).TRACe(1-4).LABel.DATA . . . . .	270
SCPI.DISPlay.TR(1-1).TRACe(1-4).LIMit.LINE . . . . .	270
SCPI.DISPlay.TR(1-1).TRACe(1-4).MODE . . . . .	270
SCPI.DISPlay.TR(1-1).TRACe(1-4).PERSistence.CLEAr . . . . .	271
SCPI.DISPlay.TR(1-1).TRACe(1-4).PERSistence.STATe . . . . .	271
SCPI.DISPlay.TR(1-1).TRACe(1-4).Y.SCALe.AUTO . . . . .	271
SCPI.DISPlay.TR(1-1).TRACe(1-4).Y.SCALe.PDIVision . . . . .	272
SCPI.DISPlay.TR(1-1).TRACe(1-4).Y.SCALe.RLEVel . . . . .	272
SCPI.DISPlay.TR(1-1).TRACe(1-4).Y.SCALe.RPOSITION . . . . .	272
SCPI.DISPlay.TR(1-1).Y.SCALe.DIVisions . . . . .	273
SCPI.DISPlay.UPDate.IMMEDIATE . . . . .	273
SCPI.DISPlay.USER(1-1).ALLTrace.PERSistence.CLEAr . . . . .	273
SCPI.DISPlay.USER(1-1).ALLTrace.Y.SCALe.AUTO . . . . .	274
SCPI.DISPlay.USER(1-1).ANNotation.MARKer.POSition . . . . .	274
SCPI.DISPlay.USER(1-1).ANNotation.MEASurement.STATe . . . . .	274
SCPI.DISPlay.USER(1-1).GRATicule.AXIS.Y.RELative . . . . .	274
SCPI.DISPlay.USER(1-1).GRATicule.AXIS.Y.STATe . . . . .	275
SCPI.DISPlay.USER(1-1).LABel.DATA . . . . .	275
SCPI.DISPlay.USER(1-1).LABel.STATe . . . . .	276
SCPI.DISPlay.USER(1-1).LIMit.FSIGn . . . . .	276
SCPI.DISPlay.USER(1-1).MAXimize . . . . .	276
SCPI.DISPlay.USER(1-1).STATe . . . . .	277
SCPI.DISPlay.USER(1-1).TABLe.STATe . . . . .	277
SCPI.DISPlay.USER(1-1).TRACe(1-8).LABel.DATA . . . . .	278
SCPI.DISPlay.USER(1-1).TRACe(1-8).LIMit.LINE . . . . .	278
SCPI.DISPlay.USER(1-1).TRACe(1-8).MODE . . . . .	278
SCPI.DISPlay.USER(1-1).TRACe(1-8).PERSistence.STATe . . . . .	279
SCPI.DISPlay.USER(1-1).TRACe(1-8).STATe . . . . .	279
SCPI.DISPlay.USER(1-1).TRACe(1-8).X.TYPE . . . . .	280
SCPI.DISPlay.USER(1-1).TRACe(1-8).X.UNIT . . . . .	280
SCPI.DISPlay.USER(1-1).TRACe(1-8).Y.SCALe.AUTO . . . . .	280
SCPI.DISPlay.USER(1-1).TRACe(1-8).Y.SCALe.PDIVision . . . . .	280
SCPI.DISPlay.USER(1-1).TRACe(1-8).Y.SCALe.RLEVel . . . . .	281
SCPI.DISPlay.USER(1-1).TRACe(1-8).Y.SCALe.RPOSITION . . . . .	281



SCPI.DISPlay.USER(1-1).TRACe(1-8).Y.UNIT . . . . .	282
SCPI.DISPlay.USER(1-1).Y.SCALe.DIVisions . . . . .	282
SCPI.DISPlay.WINDow.ACTive . . . . .	283
SCPI.FORMat.BORDer . . . . .	283
SCPI.FORMat.DATA . . . . .	284
SCPI.HCOPy.ABORt . . . . .	284
SCPI.HCOPy.IMAGe . . . . .	284
SCPI.HCOPy.IMMediate . . . . .	285
SCPI.IEEE4882.CLS . . . . .	285
SCPI.IEEE4882.ESE. . . . .	285
SCPI.IEEE4882.ESR . . . . .	286
SCPI.IEEE4882.IDN. . . . .	286
SCPI.IEEE4882.OPC . . . . .	286
SCPI.IEEE4882.OPT . . . . .	286
SCPI.IEEE4882.RST . . . . .	287
SCPI.IEEE4882.SRE . . . . .	287
SCPI.IEEE4882.STB . . . . .	287
SCPI.IEEE4882.TRG . . . . .	287
SCPI.INITiate.FP(1-1).CONTinuous . . . . .	287
SCPI.INITiate.FP(1-1).IMMediate . . . . .	288
SCPI.INITiate.PN(1-1).CONTinuous . . . . .	288
SCPI.INITiate.PN(1-1).IMMediate. . . . .	288
SCPI.INITiate.SP(1-1).CONTinuous . . . . .	288
SCPI.INITiate.SP(1-1).IMMediate . . . . .	289
SCPI.INITiate.TR(1-1).CONTinuous . . . . .	289
SCPI.INITiate.TR(1-1).IMMediate. . . . .	289
SCPI.MMEMory.CATalog_Q dir, list . . . . .	290
SCPI.MMEMory.COPY src, dst . . . . .	290
SCPI.MMEMory.DATA[_Q] file, data . . . . .	290
SCPI.MMEMory.DELeTe . . . . .	291
SCPI.MMEMory.FP(1-1).TRACe(1-4).LOAD.LIMit.LOWer . . . . .	291
SCPI.MMEMory.FP(1-1).TRACe(1-4).LOAD.LIMit.UPPer . . . . .	292
SCPI.MMEMory.FP(1-1).TRACe(1-4).STORE.DATA . . . . .	292
SCPI.MMEMory.FP(1-1).TRACe(1-4).STORE.MEMory . . . . .	293
SCPI.MMEMory.LOAD.PROGram . . . . .	293
SCPI.MMEMory.LOAD.STATe . . . . .	293
SCPI.MMEMory.MDIRectory . . . . .	294
SCPI.MMEMory.PN(1-1).TRACe(1-1).LOAD.LIMit.LOWer . . . . .	294
SCPI.MMEMory.PN(1-1).TRACe(1-1).LOAD.LIMit.UPPer . . . . .	295
SCPI.MMEMory.PN(1-1).TRACe(1-1).LOAD.SPURious.THReShold . . . . .	295
SCPI.MMEMory.PN(1-1).TRACe(1-1).STORE.DATA . . . . .	295
SCPI.MMEMory.PN(1-1).TRACe(1-1).STORE.MEMory . . . . .	296
SCPI.MMEMory.SP(1-1).TRACe(1-1).LOAD.LIMit.LOWer . . . . .	296
SCPI.MMEMory.SP(1-1).TRACe(1-1).LOAD.LIMit.UPPer . . . . .	297
SCPI.MMEMory.SP(1-1).TRACe(1-1).STORE.DATA . . . . .	297
SCPI.MMEMory.SP(1-1).TRACe(1-1).STORE.MEMory . . . . .	297
SCPI.MMEMory.STORe.IMAGe. . . . .	298
SCPI.MMEMory.STORe.PROGram . . . . .	298
SCPI.MMEMory.STORe.STATe. . . . .	299

---

## Contents

SCPI.MMEMory.STORe.STYPe . . . . .	299
SCPI.MMEMory.TR(1-1).TRACe(1-4).LOAD.LIMit.LOWer . . . . .	299
SCPI.MMEMory.TR(1-1).TRACe(1-4).LOAD.LIMit.UPPer . . . . .	300
SCPI.MMEMory.TR(1-1).TRACe(1-4).STORe.DATA . . . . .	300
SCPI.MMEMory.TR(1-1).TRACe(1-4).STORe.MEMory . . . . .	301
SCPI.MMEMory.USER(1-1).TRACe(1-8).LOAD.LIMit.LOWer . . . . .	301
SCPI.MMEMory.USER(1-1).TRACe(1-8).LOAD.LIMit.UPPer . . . . .	301
SCPI.MMEMory.USER(1-1).TRACe(1-8).STORe.DATA . . . . .	302
SCPI.MMEMory.USER(1-1).TRACe(1-8).STORe.MEMory . . . . .	302
SCPI.PROGram.CATalog . . . . .	303
SCPI.PROGram.COM.EVENTt . . . . .	303
SCPI.PROGram.SELected.NAME . . . . .	303
SCPI.PROGram.SELected.STATe . . . . .	304
SCPI.PROGram.SKEY.ITEM(1-8).ENABle . . . . .	304
SCPI.PROGram.SKEY.ITEM(1-8).IMMediate . . . . .	304
SCPI.PROGram.SKEY.ITEM(1-8).LABel . . . . .	305
SCPI.PROGram.VARiable.ARRay(1-10).DATA . . . . .	305
SCPI.PROGram.VARiable.ARRay(1-10).POINts . . . . .	305
SCPI.PROGram.VARiable.DOUBle(1-10) . . . . .	306
SCPI.PROGram.VARiable.INTegeR(1-10) . . . . .	306
SCPI.PROGram.VARiable.STRiNg(1-10) . . . . .	307
SCPI.SENSE.ATTenuation.LEVel . . . . .	307
SCPI.SENSE.FP(1-1).AVERAge.CLEAr . . . . .	308
SCPI.SENSE.FP(1-1).AVERAge.COUNt . . . . .	308
SCPI.SENSE.FP(1-1).AVERAge.STATe . . . . .	308
SCPI.SENSE.FP(1-1).FBANd . . . . .	309
SCPI.SENSE.FP(1-1).FREQuency.RESolution . . . . .	309
SCPI.SENSE.FP(1-1).SWEep.DWELl . . . . .	309
SCPI.SENSE.FP(1-1).SWEep.TIME.DATA . . . . .	310
SCPI.SENSE.PN(1-1).AVERAge.CLEAr . . . . .	310
SCPI.SENSE.PN(1-1).AVERAge.COUNt . . . . .	310
SCPI.SENSE.PN(1-1).AVERAge.STATe . . . . .	311
SCPI.SENSE.PN(1-1).CORRelation.COUNt . . . . .	311
SCPI.SENSE.PN(1-1).FBANd . . . . .	311
SCPI.SENSE.PN(1-1).FREQuency.STARt . . . . .	312
SCPI.SENSE.PN(1-1).FREQuency.STOP . . . . .	312
SCPI.SENSE.PN(1-1).IFGain . . . . .	313
SCPI.SENSE.PN(1-1).LOBandwidth . . . . .	313
SCPI.SENSE.PN(1-1).SEGTable.MEASurement.QUALity . . . . .	314
SCPI.SENSE.PN(1-1).SWEep.POINts . . . . .	314
SCPI.SENSE.ROSCillator.SOURce . . . . .	314
SCPI.SENSE.SP(1-1).AVERAge.CLEAr . . . . .	314
SCPI.SENSE.SP(1-1).AVERAge.COUNt . . . . .	315
SCPI.SENSE.SP(1-1).AVERAge.STATe . . . . .	315
SCPI.SENSE.SP(1-1).AVERAge.TYPE . . . . .	315
SCPI.SENSE.SP(1-1).BANDwidth.RESolution . . . . .	316
SCPI.SENSE.SP(1-1).CARRier.FBANd . . . . .	316
SCPI.SENSE.SP(1-1).CARRier.SET.CENTer . . . . .	317
SCPI.SENSE.SP(1-1).DETector.FUNCTion . . . . .	317

SCPI.SENSE.SP(1-1).FREQUENCY.CENTER . . . . .	317
SCPI.SENSE.SP(1-1).FREQUENCY.SPAN . . . . .	318
SCPI.SENSE.SP(1-1).FREQUENCY.START . . . . .	318
SCPI.SENSE.SP(1-1).FREQUENCY.STOP . . . . .	319
SCPI.SENSE.SP(1-1).POWER.LEVEL . . . . .	319
SCPI.SENSE.SP(1-1).SWEPT.POINTS . . . . .	320
SCPI.SENSE.TR(1-1).AVERAGE.CLEAR . . . . .	320
SCPI.SENSE.TR(1-1).AVERAGE.COUNT . . . . .	320
SCPI.SENSE.TR(1-1).AVERAGE.STATE . . . . .	321
SCPI.SENSE.TR(1-1).NARROW.FREQUENCY.PREFERENCE . . . . .	321
SCPI.SENSE.TR(1-1).NARROW.FREQUENCY.RANGE . . . . .	321
SCPI.SENSE.TR(1-1).NARROW.FREQUENCY.TARGET . . . . .	322
SCPI.SENSE.TR(1-1).NARROW.SWEPT.POINTS . . . . .	322
SCPI.SENSE.TR(1-1).NARROW.TIME.OFFSET . . . . .	322
SCPI.SENSE.TR(1-1).NARROW.TIME.REFERENCE . . . . .	323
SCPI.SENSE.TR(1-1).NARROW.TIME.SPAN . . . . .	323
SCPI.SENSE.TR(1-1).POWER.INPUT.LEVEL.MAXIMUM . . . . .	324
SCPI.SENSE.TR(1-1).WIDE.FREQUENCY.MAXIMUM . . . . .	324
SCPI.SENSE.TR(1-1).WIDE.SWEPT.POINTS . . . . .	325
SCPI.SENSE.TR(1-1).WIDE.TIME.OFFSET . . . . .	325
SCPI.SENSE.TR(1-1).WIDE.TIME.REFERENCE . . . . .	325
SCPI.SENSE.TR(1-1).WIDE.TIME.SPAN . . . . .	326
SCPI.SOURCE.FP(1-1).SWEPT.PARAMETER . . . . .	326
SCPI.SOURCE.FP(1-1).SWEPT.POINTS . . . . .	326
SCPI.SOURCE.FP(1-1).VOLTAGE.CONTROL.CENTER . . . . .	327
SCPI.SOURCE.FP(1-1).VOLTAGE.CONTROL.SPAN . . . . .	327
SCPI.SOURCE.FP(1-1).VOLTAGE.CONTROL.START . . . . .	328
SCPI.SOURCE.FP(1-1).VOLTAGE.CONTROL.STOP . . . . .	328
SCPI.SOURCE.FP(1-1).VOLTAGE.POWER.CENTER . . . . .	329
SCPI.SOURCE.FP(1-1).VOLTAGE.POWER.SPAN . . . . .	329
SCPI.SOURCE.FP(1-1).VOLTAGE.POWER.START . . . . .	329
SCPI.SOURCE.FP(1-1).VOLTAGE.POWER.STOP . . . . .	330
SCPI.SOURCE.VOLTAGE.CONTROL.AFC.FBAND . . . . .	330
SCPI.SOURCE.VOLTAGE.CONTROL.AFC.IMMEDIATE . . . . .	331
SCPI.SOURCE.VOLTAGE.CONTROL.AFC.ITERATION . . . . .	331
SCPI.SOURCE.VOLTAGE.CONTROL.AFC.LIMIT.HIGH . . . . .	332
SCPI.SOURCE.VOLTAGE.CONTROL.AFC.LIMIT.LOW . . . . .	332
SCPI.SOURCE.VOLTAGE.CONTROL.AFC.SENSITIVITY . . . . .	333
SCPI.SOURCE.VOLTAGE.CONTROL.AFC.STATE . . . . .	333
SCPI.SOURCE.VOLTAGE.CONTROL.AFC.TARGET . . . . .	334
SCPI.SOURCE.VOLTAGE.CONTROL.AFC.TOLERANCE . . . . .	334
SCPI.SOURCE.VOLTAGE.CONTROL.CORRECTION.COLLECT.ACQUIRE . . . . .	335
SCPI.SOURCE.VOLTAGE.CONTROL.CORRECTION.STATE . . . . .	335
SCPI.SOURCE.VOLTAGE.CONTROL.DELAY . . . . .	335
SCPI.SOURCE.VOLTAGE.CONTROL.LEVEL.AMPLITUDE . . . . .	336
SCPI.SOURCE.VOLTAGE.CONTROL.LEVEL.STATE . . . . .	336
SCPI.SOURCE.VOLTAGE.CONTROL.LIMIT.HIGH . . . . .	337
SCPI.SOURCE.VOLTAGE.CONTROL.LIMIT.LOW . . . . .	337
SCPI.SOURCE.VOLTAGE.POWER.DELAY . . . . .	338

---

## Contents

SCPI.SOURce.VOLTage.POWer.LEVel.AMPLitude . . . . .	338
SCPI.SOURce.VOLTage.POWer.LEVel.STATe . . . . .	339
SCPI.SOURce.VOLTage.POWer.LIMit.HIGH . . . . .	339
SCPI.SOURce.VOLTage.POWer.LIMit.LOW . . . . .	340
SCPI.STATus.OPERation.BIT12.CLEAr . . . . .	341
SCPI.STATus.OPERation.BIT12.CONDition . . . . .	341
SCPI.STATus.OPERation.BIT12.ENABLE . . . . .	341
SCPI.STATus.OPERation.BIT12.EVENT . . . . .	342
SCPI.STATus.OPERation.BIT12.NTRansition . . . . .	342
SCPI.STATus.OPERation.BIT12.PTRansition . . . . .	342
SCPI.STATus.OPERation.BIT12.SET . . . . .	343
SCPI.STATus.OPERation.CONDition . . . . .	343
SCPI.STATus.OPERation.ENABLE . . . . .	343
SCPI.STATus.OPERation.EVENT . . . . .	344
SCPI.STATus.OPERation.NTRansition . . . . .	344
SCPI.STATus.OPERation.PTRansition . . . . .	344
SCPI.STATus.PRESet . . . . .	345
SCPI.STATus.QUEStionable.CONDition . . . . .	345
SCPI.STATus.QUEStionable.CURRent.ENABLE . . . . .	345
SCPI.STATus.QUEStionable.CURRent.EVENT . . . . .	345
SCPI.STATus.QUEStionable.ENABLE . . . . .	345
SCPI.STATus.QUEStionable.EVENT . . . . .	346
SCPI.STATus.QUEStionable.LIMit.CONDition . . . . .	346
SCPI.STATus.QUEStionable.LIMit.ENABLE . . . . .	346
SCPI.STATus.QUEStionable.LIMit.EVENT . . . . .	347
SCPI.STATus.QUEStionable.LIMit.FP(1-1).CONDition . . . . .	347
SCPI.STATus.QUEStionable.LIMit.FP(1-1).ENABLE . . . . .	347
SCPI.STATus.QUEStionable.LIMit.FP(1-1).EVENT . . . . .	347
SCPI.STATus.QUEStionable.LIMit.FP(1-1).NTRansition . . . . .	347
SCPI.STATus.QUEStionable.LIMit.FP(1-1).PTRansition . . . . .	348
SCPI.STATus.QUEStionable.LIMit.NTRansition . . . . .	348
SCPI.STATus.QUEStionable.LIMit.PN(1-1).CONDition . . . . .	349
SCPI.STATus.QUEStionable.LIMit.PN(1-1).ENABLE . . . . .	349
SCPI.STATus.QUEStionable.LIMit.PN(1-1).EVENT . . . . .	349
SCPI.STATus.QUEStionable.LIMit.PN(1-1).NTRansition . . . . .	349
SCPI.STATus.QUEStionable.LIMit.PN(1-1).PTRansition . . . . .	350
SCPI.STATus.QUEStionable.LIMit.PTRansition . . . . .	350
SCPI.STATus.QUEStionable.LIMit.SP(1-1).CONDition . . . . .	351
SCPI.STATus.QUEStionable.LIMit.SP(1-1).ENABLE . . . . .	351
SCPI.STATus.QUEStionable.LIMit.SP(1-1).EVENT . . . . .	351
SCPI.STATus.QUEStionable.LIMit.SP(1-1).NTRansition . . . . .	351
SCPI.STATus.QUEStionable.LIMit.SP(1-1).PTRansition . . . . .	352
SCPI.STATus.QUEStionable.LIMit.TR(1-1).CONDition . . . . .	352
SCPI.STATus.QUEStionable.LIMit.TR(1-1).ENABLE . . . . .	352
SCPI.STATus.QUEStionable.LIMit.TR(1-1).EVENT . . . . .	353
SCPI.STATus.QUEStionable.LIMit.TR(1-1).NTRansition . . . . .	353
SCPI.STATus.QUEStionable.LIMit.TR(1-1).PTRansition . . . . .	353
SCPI.STATus.QUEStionable.LIMit.USER(1-1).CONDition . . . . .	354
SCPI.STATus.QUEStionable.LIMit.USER(1-1).ENABLE . . . . .	354

SCPI.STATus.QUEStionable.LIMit.USER(1-1).EVENTt . . . . .	354
SCPI.STATus.QUEStionable.LIMit.USER(1-1).NTRansition . . . . .	355
SCPI.STATus.QUEStionable.LIMit.USER(1-1).PTRansition . . . . .	355
SCPI.STATus.QUEStionable.MISC.ENABLE . . . . .	355
SCPI.STATus.QUEStionable.MISC.EVENTt . . . . .	356
SCPI.STATus.QUEStionable.NTRansition . . . . .	356
SCPI.STATus.QUEStionable.PHAsE.ENABLE . . . . .	356
SCPI.STATus.QUEStionable.PHAsE.EVENTt . . . . .	357
SCPI.STATus.QUEStionable.POWer.ENABLE . . . . .	357
SCPI.STATus.QUEStionable.POWer.EVENTt . . . . .	357
SCPI.STATus.QUEStionable.PTRansition . . . . .	358
SCPI.STATus.QUEStionable.REFerence.ENABLE . . . . .	358
SCPI.STATus.QUEStionable.REFerence.EVENTt . . . . .	358
SCPI.SYSTem.BACKlight.STATe . . . . .	359
SCPI.SYSTem.BEEPPer.COMPLete.IMMediate . . . . .	359
SCPI.SYSTem.BEEPPer.COMPLete.STATe . . . . .	359
SCPI.SYSTem.BEEPPer.WARNing.IMMediate . . . . .	360
SCPI.SYSTem.BEEPPer.WARNing.STATe . . . . .	360
SCPI.SYSTem.DATE[_Q] year, month, day. . . . .	361
SCPI.SYSTem.ERRor.NEXT_Q err_no, err_desc . . . . .	361
SCPI.SYSTem.KLOCK.KBD . . . . .	362
SCPI.SYSTem.KLOCK.MOUSE . . . . .	362
SCPI.SYSTem.POFF . . . . .	362
SCPI.SYSTem.PRESet . . . . .	363
SCPI.SYSTem.TIME[_Q] hour, minute, second . . . . .	363
SCPI.TRIGger.EXTernal.SLOPe . . . . .	364
SCPI.TRIGger.FP(1-1).MODE . . . . .	364
SCPI.TRIGger.FP(1-1).SOURce . . . . .	365
SCPI.TRIGger.MODE . . . . .	365
SCPI.TRIGger.PN(1-1).SOURce . . . . .	365
SCPI.TRIGger.SP(1-1).SOURce . . . . .	366
SCPI.TRIGger.TR(1-1).NARRow.VIDeo.FREQuency.CENTer . . . . .	366
SCPI.TRIGger.TR(1-1).NARRow.VIDeo.THReshold . . . . .	367
SCPI.TRIGger.TR(1-1).SOURce . . . . .	367
SCPI.TRIGger.TR(1-1).WIDE.VIDeo.FREQuency.CENTer . . . . .	368
COM Object List . . . . .	369
List by function . . . . .	369
List by softkey . . . . .	397
<b>A. Manual Changes</b>	
Manual Changes . . . . .	458
Change 2 . . . . .	459
Change 1 . . . . .	459



---

# 1 Making Effective Use of This Manual

This chapter provides an overview of this manual as well as useful information to help you navigate through the manual. It also briefly describes how to use this manual, focusing on how you can look up particular COM objects and code their corresponding commands.

## Contents of This Manual

This is a VBA programming guide with Agilent E5052A single source analyzer. This guide describes programming method mainly aiming at learning how to write a program that controls the E5052A using COM objects, focusing on the macro function of the E5052A and sample usage with the built-in VBA.

Controlling the E5052A using an external controller is not covered by this guide; it is described in *Programmer's Guide*.

Description in this guide assumes that the reader has learned manual operation of the E5052A. For detailed information on each feature, see *User's Guide*.

The chapter-by-chapter contents of this manual are as follows.

- o Chapter 1, "Making Effective Use of This Manual," on page 23  

This chapter provides an overview of this manual as well as useful information to help you navigate through the manual. It also briefly describes how to use this manual, focusing on how you can look up particular COM objects and code their corresponding commands.
- o Chapter 2, "Introduction to VBA Programming," on page 27  

This chapter introduces you to the E5052A's VBA macro function, explains how you can implement your system using the VBA macro function, and provides an overview of the COM objects that come with the E5052A.
- o Chapter 3, "Operation Basics of the E5052A's VBA," on page 33  

This chapter provides descriptive information on basic operations for creating VBA programs within the E5052A's VBA environment. Topics include launching Visual Basic Editor as well as creating, saving, and running VBA programs.
- o Chapter 4, "Controlling the E5052A," on page 69  

This chapter explains how to use the E5052A's VBA to control the E5052A itself.
- o Chapter 5, "User Defined Window," on page 87
- o Chapter 6, "Controlling Peripherals," on page 93  

This chapter explains how to control peripherals connected to the E5052A with GPIB by using the software (VISA library) installed in the E5052A.
- o Chapter 7, "COM Object Reference," on page 99  

This chapter describes the COM object model of the Agilent E5052A and the COM object reference in alphabetical order. If you want to look up COM objects by corresponding front panel keys, see "COM object list by front panel key."
- o Appendix A, "Manual Changes," on page 457



This appendix contains the information required to adapt this manual to the versions or configurations of the Agilent E5052A which were manufactured earlier than the printing date of this manual.

## How to Use This Manual

Chapter 3, “Operation Basics of the E5052A’s VBA,” on page 33 provides the basic operation of VBA for coding VBA programs.

Chapter 4, “Controlling the E5052A,” on page 69 and Chapter 6, “Controlling Peripherals,” on page 93 will help you to develop your custom programs.

For more information on individual COM object, see Chapter 7, “COM Object Reference,” on page 99.

## Looking Up COM Objects

Chapter 7, “COM Object Reference,” on page 99 contains a complete reference of COM objects. You can look up a particular COM object in any of the following ways:

### Lookup by Abbreviated COM Object Name

The COM object reference is organized alphabetically according to the abbreviated name used as the title for each COM object’s description.

### Lookup by Soft key

Chapter 7, “COM Object Reference,” provides a complete list of COM objects that correspond to the soft key and indicates the page numbers where the COM objects appear in the COM object reference (see “List by softkey” on page 397).

## How to Code the Corresponding Commands

The description of each function may contain the corresponding SCPI commands. If SCPI command exists for each measurement window, use *xx*.

*Example: SCPI.CALCulate.xx.TRACe.DATA.FDATA*

The parameters for each measurement window are as follows:

- **FP**: Frequency/Power measurement
- **PN**: Phase noise measurement
- **SP**: Spectrum monitor measurement
- **TR**: Transient measurement
- **USER**: User window

---

### NOTE

Some SCPI commands may not make use of particular measuring windows.

---

## 2 Introduction to VBA Programming

This chapter introduces you to the E5052A's VBA macro function, explains how you can implement your system using the VBA macro function, and provides an overview of the COM objects that come with the E5052A.

## Introduction to the E5052A Macro Function

The E5052A has a built-in macro function that allows a single instruction to substitute for multiple instructions. You can have the E5052A automatically execute your own macro program that contains a series of VBA (Visual Basic for Application) statements.

VBA is based on the VB (Visual Basic) programming language. Although VBA is similar to VB, they are not the same. Although some of the VB features were eliminated from VBA, new application-specialized features were added. In particular, the E5052A's VBA has features for controlling the E5052A. For details of the differences between VBA and VB, refer to Microsoft official guides and various books on VBA.

For information on the basic operating procedures of the E5052A's VBA, see Chapter 3, "Operation Basics of the E5052A's VBA," on page 33. This manual is not meant to be an in-depth guide to VBA programming basics and the syntax of VBA functions and commands. Such in-depth information is covered in VBA Help, Microsoft official guides, and various books on VBA.

The macro function allows you to control the E5052A itself as well as various peripherals. You can do the following:

1. Automate repetitive tasks

You can use the E5052A's macro function to combine several processes into one. Automating repetitive tasks provides higher efficiency and eliminates human error. Once you have contained repetitive tasks in sub-procedures, you can later call the procedures from other programs, thus allowing effective reuse of programming assets.

2. Implement a user interface

The E5052A VBA supports user forms (see "User form" on page 37) that facilitate creating a visual user interface. User forms guide users through common tasks such as performing measurement and entering data without requiring familiarity with the E5052A, thus minimizing the possibility of human error.

## Overview of Control System Based on Macro Function

This section explains how you can use the E5052A's built-in VBA macro function to implement a system that controls the E5052A and peripherals and describes the command sets that are available for such purposes.

### Implementing a control system

Macro-based control systems are classified into two types: As shown in Figure 2-1, a VBA control system controls the E5052A itself while a VBA remote control system controls peripherals. When you use the macro function to control peripherals, you must connect the E5052A with the peripherals through USB/GPIB interface and configure them to communicate over VISA (Virtual Instrument Software Architecture). For information on programming using the VISA library, refer to "Programming with VISA" on page 95.

Figure 2-1

Configuration example of control system using macro environment

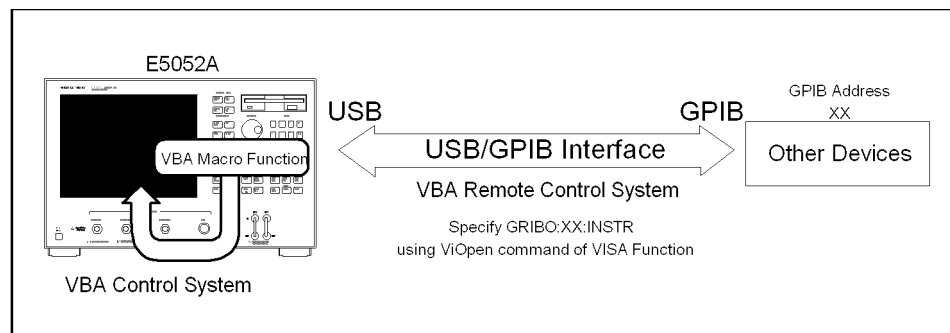

e5052ave013

### Required equipment

1. E5052A
2. Peripherals and/or other purpose-specific instruments
3. USB/GPIB interface

#### NOTE

To use the VBA remote control system, you need to set the USB/GPIB interface correctly. For details, refer to the *User's Guide*.

#### NOTE

Do not connect two or more USB/GPIB interfaces.

## **Control methods**

The command set you can use differs depending on whether you use the macro function to control the E5052A or a peripheral.

### **Controlling the E5052A**

When you want to control the E5052A itself, you can create a program using COM objects within the E5052A VBA environment. E5052ACOM objects that come with the E5052A include three objects specific to the COM interface and COM objects that correspond to SCPI commands. For information on objects, refer to “COM Object Model” on page 100.

For information on using the E5052A’s COM objects, see Chapter 7, “COM Object Reference,” on page 99. For information on using SCPI commands, see the “SCPI Command Reference” in the *Programmer’s Guide*.

### **Controlling Peripherals**

When you want to control a peripheral, you can create a program by using VISA library functions within the E5052A VBA environment.

For information on using the VISA library, see Chapter 6, “Controlling Peripherals,” on page 93. For a complete description of VISA functions, refer to the VISA library’s online help. You can access this online help by double-clicking a file named visa.hlp contained in the CD-ROM (Agilent part No. E5052-9050x).

For information on the GPIB commands available with a particular peripheral, refer to the documentation that comes with the peripheral.

---

**NOTE**

The number position shown by “x” in the part numbers above indicates the edition number.

---

## E5052A Overview of COM Objects

The VBA environment provides COM objects that support users in controlling the E5052A. This section provides an overview of COM objects as well as important considerations for using the E5052A's COM objects. For more information on the E5052A's COM objects and a comparison with SCPI commands, refer to Chapter 7, "COM Object Reference," on page 99.

The definitions and specifications of COM are beyond the scope of this guide. Such in-depth information is covered in a variety of books on COM.

### About COM objects

When you control the E5052A through the macro function, you can use COM objects as components of your application. The functionality of the E5052A's COM objects is expressed through properties and methods.

#### Properties

A property allows you to read or write a setting or attribute of an object. With the E5052A, you can use properties to set or read the settings of the E5052A.

You can find properties in the description of syntax in Chapter 7, "COM Object Reference," on page 99). They set and obtain the values for a command.

#### Methods

A method allows you to manipulate an object in a particular way. With the E5052A, you can use methods to perform specific tasks.

You can find methods in the description of syntax in Chapter 7, "COM Object Reference," on page 99, which only describes commands.

#### Events

An event means an operation from outside that the program can recognize, such as clicking a mouse button. Without using user forms, the E5052A lets you perform an entire procedure assigned to a specific softkey as an event by simply pressing that softkey. This is particularly useful, for example, when the user wants an interruption in a VBA program that gives an option of whether to proceed. For more information, refer to "Executing a Procedure with a Softkey (user menu function)" on page 76.

### **Using COM objects to control the E5052A**

When you want to control the E5052A, you can use COM objects alone or in conjunction with SCPI commands and the **Parse** on page 104 object. The latter method is slightly slower than the former because the **Parse** on page 104 object is used to parse the messages of SCPI commands. For instructions on using the E5052A's VBA Editor to create a program that uses COM objects, refer to Chapter 3, "Operation Basics of the E5052A's VBA," on page 33.

### **Major control difference between COM objects and SCPI commands**

For information on the major control differences between using COM objects and SCPI commands, refer to "SCPI Objects" on page 101.



---

## 3

# Operation Basics of the E5052A's VBA

This chapter provides descriptive information on basic operations for creating VBA programs within the E5052A's VBA environment. Topics include launching Visual Basic Editor as well as creating, saving, and running VBA programs.

---

## Displaying Visual Basic Editor

This section describes how to launch Visual Basic Editor.

**Step 1.** From the E5052A measurement screen, launch Visual Basic Editor using the following method:

- [Macro Setup] - VBA Editor Menu - Open Editor

### Initial Screen of Visual Basic Editor

When you launch Visual Basic Editor, it displays the initial screen, which contains a number of windows as shown in Figure 3-1. This section provides information on the names and functions of the main display areas.

Figure 3-1

Example of Visual Basic Editor initial screen

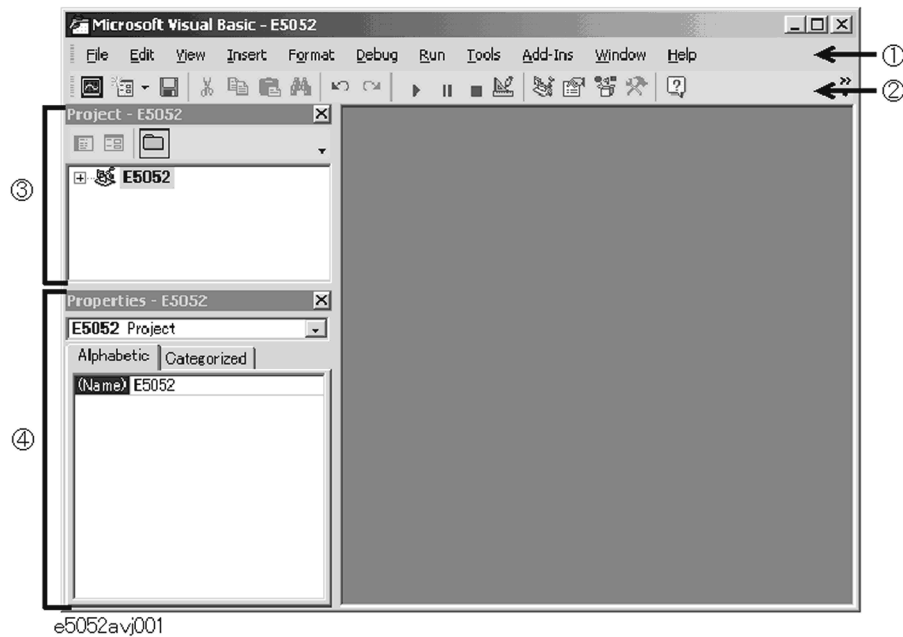

#### 1. Menu Bar

Clicking one of the menu labels brings up the corresponding menu. The menu bar can be used as the primary method for navigating through the E5052A's VBA environment.

#### 2. Toolbar

The toolbar provides access to commonly used commands via icon buttons; these commands are a subset of the commands accessible from the menu bar. For descriptions of the buttons on the standard toolbar, see Figure 3-2.

Figure 3-2

Buttons on the standard toolbar

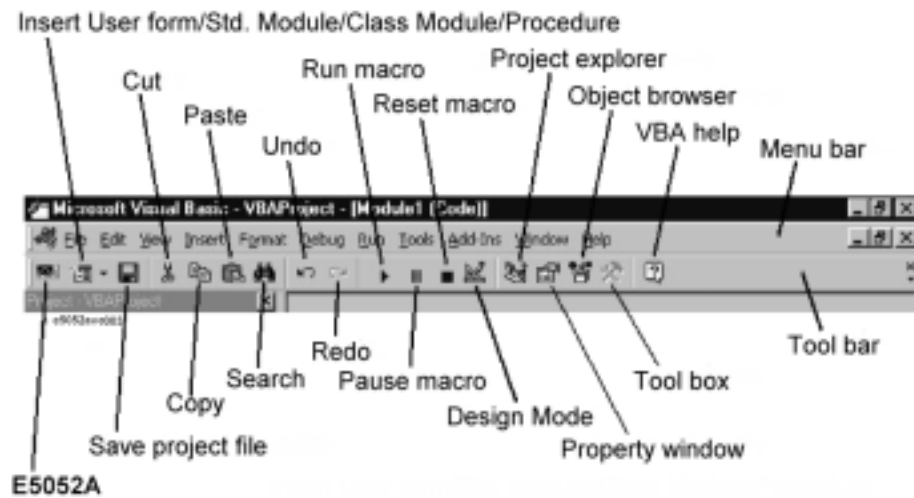

### 3. Project Explorer

Within the E5052A's VBA environment, you can develop your application as a project that consists of a number of files (modules). Project Explorer shows a list of all files (modules) that make up a project. The list also includes files (modules) created or loaded in Visual Basic Editor. For information on modules, refer to "A Project and Three Types of Modules" on page 37.

**Step 1.** To display the project explorer, do one of the following:

- On the **View** menu, click **Project Explorer**.
- Press **[Ctrl] + [R]** on the keyboard.
- On the toolbar, click the "Project Explorer" icon (Figure 3-2).

### 4. Property Window

A property window shows the settings (label, font, color, size, etc.) of a control (such as a command button or text box) placed on the user form. For information on user forms, refer to "User form" on page 37.

You can also set properties by programming in the code window.

**Step 1.** To display the property window, do one of the following:

- On the **View** menu, click **Properties Window**.
- Press **[F4]** on the keyboard.
- On the toolbar, click the "Property Window" icon (Figure 3-2).

---

## Closing Visual Basic Editor

This section describes how to quit Visual Basic Editor.

## Switching to the E5052A Measurement Screen

**Step 1.** Close Visual Basic Editor using one of the following methods:

- On Visual Basic Editor's **File** menu, click **Close and Return to Application**.
- Within Visual Basic Editor, press **[Alt] + [Q]** on the keyboard.
- **[Macro Setup] - VBA Editor Menu - Close Editor** (E5052A Measurement Screen)

---

### NOTE

Whenever you launch Visual Basic Editor, it automatically displays the project files you used in the previous session. However, once you turn off the power to the E5052A, the project files kept in memory will be lost; therefore, it is strongly recommended that you save your VBA programs before turning off the power.

---

---

## Switching to the E5052A Measurement Screen

You can switch to the E5052A measurement screen without closing Visual Basic Editor.

**Step 1.** To switch to the E5052A measurement screen, do one of the following:

- On the **View** menu, click **Application**.
- Press **[Alt] + [F11]** on the keyboard.
- On the toolbar, click the “E5052A” icon (Figure 3-2).
- Press the **[Focus]** key on the E5052A front panel.

## Necessary Preparation Before Coding

### A Project and Three Types of Modules

Project Explorer (Figure 3-1) displays a list of files (modules) that are used in the E5052A VBA. This section describes a project composed of a number of files (modules) and three types of modules (“user form,” “standard,” and “class”). Each type of module performs its respective tasks as described below.

#### Project

When you develop an application within the E5052A’s VBA environment, you use a number of VBA program files (modules) and manage them as one project. The project is saved with the file extension “.vba”.

#### User form

A user form contains controls such as buttons and text boxes. You can code event-driven procedures that are invoked when a particular event occurs on a particular control, thereby creating a user interface. The user form is saved with the file extension “.frm”.

#### Standard module

A standard module contains a collection of one or more procedures (subprograms enclosed between Sub and End Sub). One typical use of a standard module is to contain shared subroutines and globally called functions. The standard module is saved with the file extension “.bas”.

#### Class module

A class module contains both data and procedures and acts as one object. Once you have created a class module that serves as an object, you can create any number of instances of that object by naming each instance as an object variable. While each procedure must be unique in a standard module, you can have multiple instances of an object created through a class module. The class module is saved with the file extension “.cls”.

## Displaying a Code Window

The code windows appear in the Visual Basic Editor when you insert modules in a project. A code window offers a practical environment for coding (programming).

The E5052A's VBA environment does not allow you to manage multiple projects. You can replace the current project in the Visual Basic Editor by loading a saved project file. This can be done by the following method from the E5052A measurement screen.

- **[Macro Setup] - VBA Editor Menu - New Project**

---

### NOTE

When you replace the current project with a new project, a message asking whether to save the current project may appear. If you want to save the project, click the **Yes** button to display a dialog box for saving the file (Figure 3-6 on page 45). For more on saving a project, see "Saving a project file" on page 45.

---

## Inserting the user form

Within Visual Basic Editor, do one of the following to add a user form to your project (this brings up the window shown in Figure 3-3):

- On the **Insert** menu, click **UserForm**.
- On the toolbar, click the "Insert User Form/Standard Module/Class Module/Procedure" icon (Figure 3-2) and then click **UserForm**.
- In Project Explorer (Figure 3-1), right-click the "E5052" icon and then click **Insert - UserForm**.

---

### NOTE

Adding a user form does not automatically open the code window for that user form. To open the code window, click the "Show Code" icon (Figure 3-3) in Project Explorer (Figure 3-1) or double-click a control placed on the user form.

---

Figure 3-3

Adding a user form

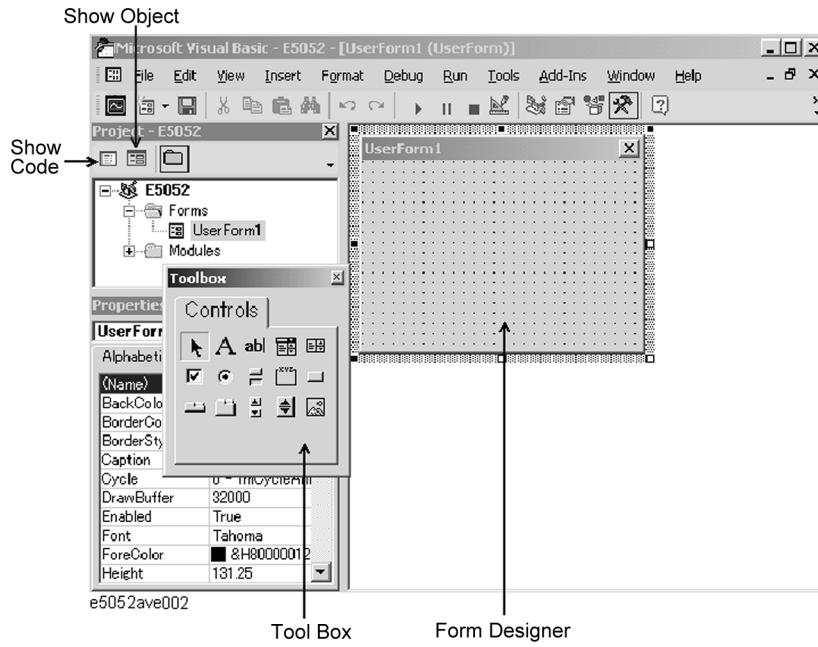

### Inserting the standard module

Within Visual Basic Editor, do one of the following to add a standard module to your project (this brings up the window shown in Figure 3-4):

- On the **Insert** menu, click **Module**.
- On the toolbar, click the “Insert User Form/Standard Module/Class Module/Procedure” icon (Figure 3-2) and then click **Module**.
- In Project Explorer (Figure 3-1), right-click the “E5052” icon and then click **Insert - Module**.

Figure 3-4

### Adding a standard module/class module

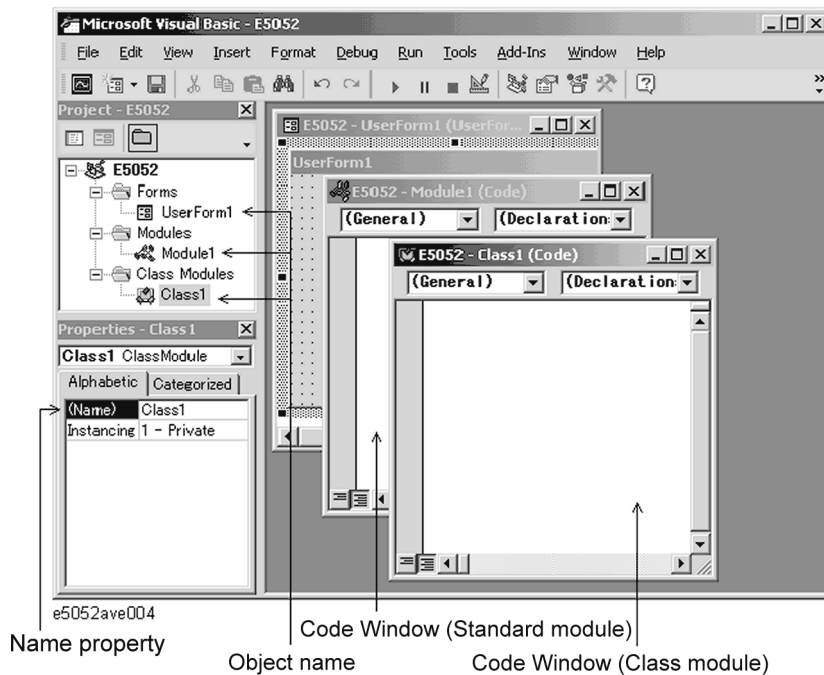

### Inserting the class module

Within Visual Basic Editor, do one of the following to add a class module to your project (this brings up the window shown in Figure 3-4):

- On the **Insert** menu, click **Class Module**.
- On the toolbar, click the “Insert User Form/Standard Module/Class Module/Procedure” icon (Figure 3-2) and then click **Class Module**.
- In Project Explorer (Figure 3-1), right-click the “E5052” icon and then click **Insert - Class Module**.

### Deleting Modules

You can delete any unnecessary module from the project within Visual Basic Editor. The following procedure assumes that you want to delete a class module named “Class1”.

- Step 1.** In Project Explorer (Figure 3-1), click the “Class1” class module under the “Class



Modules” icon to highlight it.

**Step 2.** Delete the “Class1” class module using one of the following methods:

- On the **File** menu, click **Remove Class1....**
- Click the right mouse button and then click **Remove Class1....**

**Step 3.** When you are prompted to confirm whether to export (save) “Class1,” click **No**. Alternatively, you can click **Yes** if you want to save the module.

## Coding a VBA Program

This section provides descriptive information on the user interface elements of a code window that lets you code a VBA program and walks you through a sample program (procedure) that finds the maximum value contained in an array. This should help you gain insight into how to create your own programs.

### User Interface Elements of a Code Window

A code window is where you code a VBA program. When you are working with a user form, you can open the code window for that user form by double-clicking a control (such as a button or text box) placed on the form. Similarly, when you are working with a standard or class module, you can open the code window associated with that module by double-clicking the module's icon in Project Explorer (Figure 3-1).

Figure 3-5

Code window for a standard module

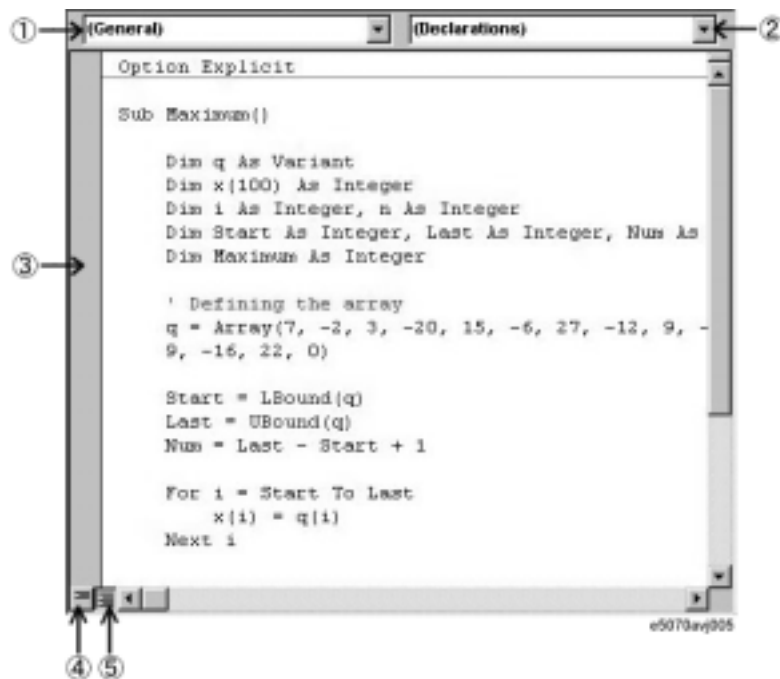

#### 1. Object box

Provides a list of objects currently used within the code window.

#### 2. Procedure box

Provides a list of procedures that reside within the code window. When you are working with a user form, this provides a list of events (actions such as click or double-click).

#### 3. Margin indicator bar

Primarily intended for use when debugging a program.

**4. Show Procedure button**

Displays only the procedure at the cursor position.

**5. Show Module button**

Displays the entire program contained in the code window.

### Auto-complete Feature

When you use COM objects in the E5052A Visual Basic Editor, the editor's auto-complete feature allows you to easily type in keywords without misspelling them.

The following procedure assumes that you are entering the SCPI.INITiate.FP.CONTinuous object.

- Step 1.** In a standard module, type **sub main** and press the **[Enter]** key. **End Sub** is automatically added.
- Step 2.** Typing **scpi** followed by a dot (.) brings up a list of classes under the SCPI class.
- Step 3.** Typing **in** automatically moves the focus to **INITiate** in the list box.
- Step 4.** Typing **INITiate** followed by a dot (.) brings up a list of classes under the SCPI class.
- Step 5.** Typing **f** automatically moves the focus to **FP** in the list box.
- Step 6.** Typing **FP** followed by a dot (.) brings up a list of classes under the SCPI class.
- Step 7.** Typing **c** automatically moves the focus to **CONTinuous** in the list box.
- Step 8.** **=** is typed to bring up a list box for setting a Boolean value (**True/False**).
- Step 9.** Typing **t** automatically moves the focus to **True**.
- Step 10.** Pressing the **[Enter]** key completes the statement: `SCPI.INITiate.FP.CONTinuous = True.`

## Saving a VBA Program

You can save VBA programs either as one complete project or on a module-by-module basis.

### Saving a project file

When you decide to save your program as one complete project, you can gather the files (modules) making up the project into a single package. A project is saved as a .vba file. You can save your program to a project file by using one of the following two methods:

#### Saving a project from Visual Basic Editor

**Step 1.** Open the Save As dialog box by doing one of the following:

- On the **File** menu, click **Save xxx.VBA**. “xxx” represents the file name.
- On the toolbar, click the “Save Project File” icon (Figure 3-2).
- Press **[Ctrl] + [S]** on the keyboard.

**Step 2.** The Save As dialog box (Figure 3-6) appears. Specify the file name and location (drive or folder) and click **Save**.

The Save As dialog box has the following user interface elements:

Figure 3-6

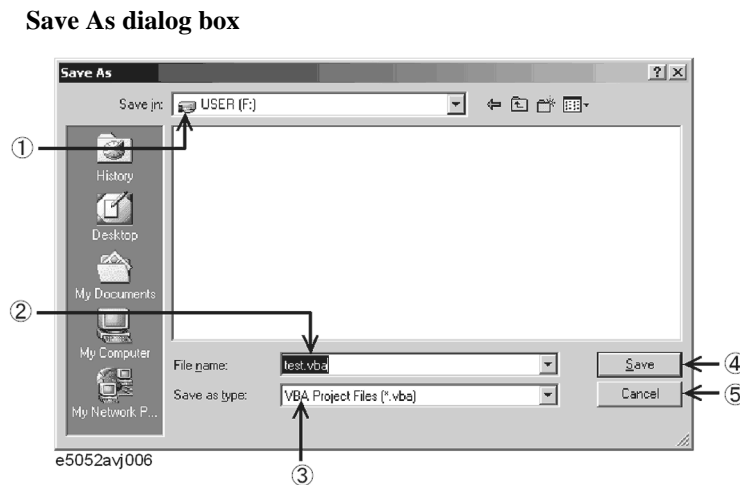

- 1. Save in:** Specify the location (drive or folder) where you want to save the file.
- 2. File name** Type in the file name.
- 3. Save as type:** Select the type of the file you are saving. Normally, you should select **VBA Project Files [\*.vba]**.
- 4. Save:** Clicking this button saves the project.
- 5. Cancel:** Clicking this button closes the Save As dialog box without saving the file and brings you back to the main screen.

### **Saving a project from the E5052A measurement screen**

- Step 1.** Display the E5052A measurement screen by following the instructions given in “Switching to the E5052A Measurement Screen” on page 36.
- Step 2.** Open the Save As dialog box using the following key sequence:
- **[Macro Setup] - VBA Editor Menu - Save Project**
- Step 3.** The Save As dialog box (Figure 3-6) appears. Specify the file name and location (drive or folder) and click **Save**.

### **Saving a module (exporting)**

Alternatively, you can save each module (user form, standard, or class) of your VBA program individually. To save a module, you must use Visual Basic Editor. User forms are saved as .frm files, standard modules as .bas files, and class modules as .cls files.

- Step 1.** In Project Explorer (Figure 3-1), click the file name that appears under the desired module icon to highlight it.
- Step 2.** Open the Export File dialog box by doing one of the following:
- On the **File** menu, click **Export File...**
  - Click the right mouse button, and click **Export File...**
  - Press **[Ctrl] + [E]** on the keyboard.
- Step 3.** The Save As dialog box (Figure 3-7) appears. Specify the file name and location (drive or folder) and click **Save**.

The Export File dialog box has the following user interface elements:

Figure 3-7

Export File dialog box

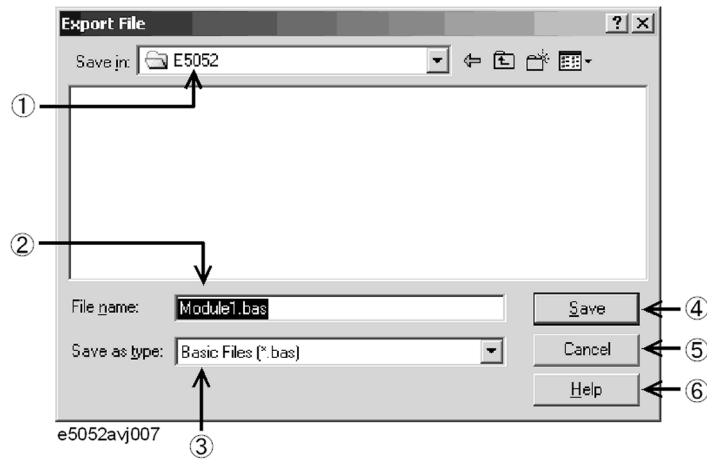

- 1. **Save in:** Specify the location (drive or folder) where you want to save the file.
- 2. **File name** Type in the file name.
- 3. **Save as type:** Select the type of module you are saving. The type that corresponds to the module you are saving is selected by default. Normally, you should use the default.
- 4. **Save:** Clicking this button saves the module.
- 5. **Cancel:** Clicking this button closes the Export File dialog box and brings you back to the main screen.
- 6. **Help:** Brings up VBA Online Help.

## Loading a VBA Program

Once you have saved a project or module file, you can load it later whenever necessary.

### Loading a project

You can load a saved project file either from the E5052A measurement screen or by specifying that the project file be automatically loaded when the power is turned on.

#### Loading a project from the E5052A measurement screen

**Step 1.** Access the Open dialog box using the following key sequence:

- **[Macro Setup] - VBA Editor Menu - Load Project**

#### NOTE

When another project is already loaded on the Visual Basic Editor, a message asking whether you want to save the current project may appear. If you want to save the project, click the **Yes** button to display a dialog box for saving (Figure 3-6 on page 45). For saving the project, see “Saving a project file” on page 45.

**Step 2.** The Open dialog box (Figure 3-8) appears. Specify the file name and location (drive or folder) of the file you want to load and click **Open**.

The Open dialog box has the following user interface elements:

Figure 3-8

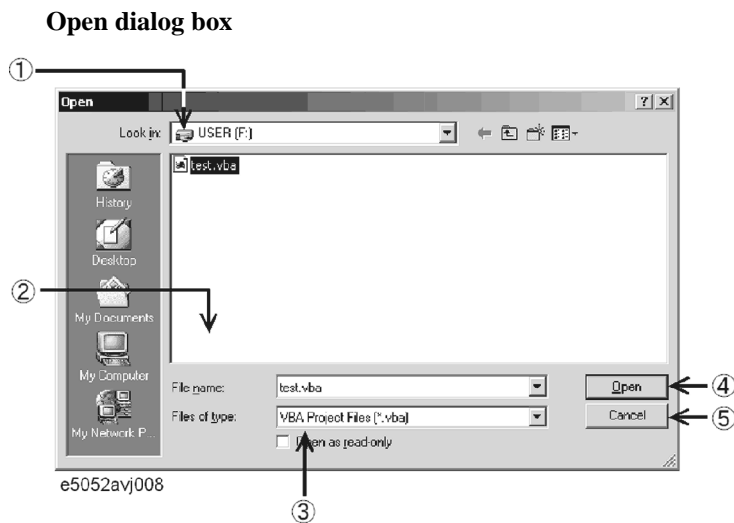

- 1. Look in:** Specify the location (drive or folder) where the project resides.
- 2. File name:** Specify the file name of the project you want to load.
- 3. Files of type:** Select the type of file you want to load. Normally, you should select **VBA Project Files [\*.vba]**.
- 4. Open:** Clicking this button loads the project.
- 5. Cancel:** Clicking this button closes the Open dialog box without loading a



project and brings you back to the main screen.

### Automatically loading a project at power-on

Once you have saved a project file that satisfies the following conditions, the project will automatically load whenever the power is turned ON.

Auto-loaded project	Condition
Directory where the project resides.	A:\(A:\) or F:\(F:\)
Project file name	autoload.vba *1

\*1.Upper/lower case insensitive.

#### NOTE

If there is the file named “autoload.vba” in both the A drive and the F drive, the file in the A drive is used.

### Loading a module (importing)

To load a saved module into a project, you must use Visual Basic Editor.

- Step 1.** In Project Explorer (Figure 3-1), click the file name that appears under the desired module icon to highlight it.
- Step 2.** Open the Import File dialog box by doing one of the following:
  - On the **File** menu, click **Import File...**
  - In Project Explorer (Figure 3-1), right-click the E5052 icon and then click **Import File...**
  - Press **[Ctrl] + [M]** on the keyboard.
- Step 3.** The Import File dialog box (Figure 3-9) appears. Specify the file name and location (drive or folder) of the file (module) you want to load and click **Open**.

Operation Basics of the E5052A's VBA  
**Loading a VBA Program**

The Import File dialog box has the following user interface elements:

**Figure 3-9**

**Import File dialog box**

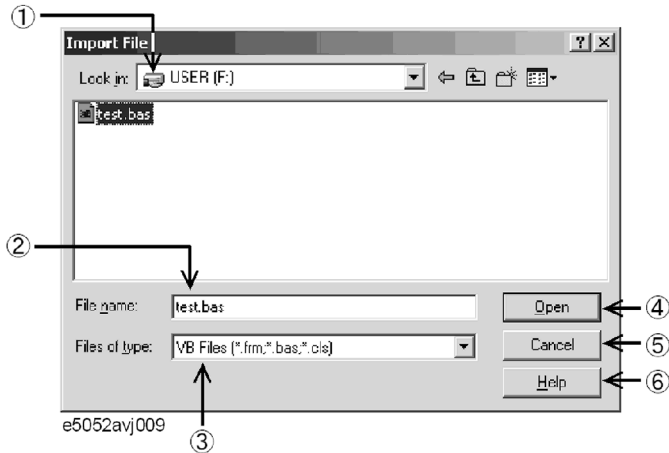

- 1. Look in:** Specify the location (drive or folder) where the module resides.
- 2. File name:** Specify the file name of the module you want to load.
- 3. Files of type:** Select the type of file you want to load. Normally, you should select **VB Files [\*.frm;\*.bas;\*.cls]**.
- 4. Open:** Clicking this button loads the module.
- 5. Cancel:** Clicking this button closes the Import File dialog box without loading a module and brings you back to the main screen.
- 6. Help:** Brings up VBA Online Help.

## Running a VBA Program

The E5052A provides two methods to execute a VBA program: executing a program that you previously loaded and loading and executing a program in a batch process. The execution status of the VBA program is indicated in the instrument status bar, as shown in Figure 3-10. “Run” indicates that the program is running while “Stop” indicates that the program is stopped.

Figure 3-10

Instrument status bar indicating the status of the VBA program



### Running a previous loaded VBA program

#### Running a program from Visual Basic Editor

The E5052A allows you to run a previously loaded VBA program by using one of the four methods listed in Step 1. below.

- Step 1.** Open the Macros dialog box (Figure 3-11) by doing one of the following:
- On the **Run** menu, click **Run Sub/UserForm**.
  - On the **Tools** menu, click **Macros....**
  - On the toolbar, click the “Run Macro” icon (Figure 3-2).
  - Press **[F5]** on the keyboard.

#### NOTE

Doing the above steps with the cursor positioned within a procedure in the code window immediately runs the program without displaying the Macros dialog box.

- Step 2.** In the Macros dialog box, select the VBA program (procedure name) you want to run and click the **Run** button.

The Macros dialog box has the following user interface elements:

**Figure 3-11** Macros dialog box



- 1. Macro Name:** Select the VBA program (procedure name) you want to run from the list box so that its name appears here.
- 2. Macro In:** Specify the project that contains the VBA program you want to run. Normally, use the default.
- 3. Run:** Clicking this button runs the selected VBA program (procedure).
- 4. Cancel:** Clicking this button closes the Macros dialog box without running a VBA program and brings you back to the main screen.
- 5. Step Into:** Clicking this button brings up Visual Basic Editor and puts it into step-in mode, where the selected VBA program is run step by step. This mode is primarily intended for use when debugging a VBA program. For more information on step-in mode, see “Debug toolbar” on page 58.
- 6. Edit:** Displays the code of the selected VBA program. You can use this for re-editing your code.
- 7. Create:** This button is normally dimmed.
- 8. Delete:** Clicking this button deletes the selected VBA program. Take care not to inadvertently delete your VBA program before saving it.

---

**NOTE**

The Macros dialog provides access to subprograms without a parameter (procedures enclosed between **Sub( )** and **End Sub**) created in a standard module.

### Running a program from the E5052A measurement screen

You can run a program from the E5052A measurement screen by using the method below.

- Step 1.** Display the E5052A measurement screen following the instructions given in “Switching to the E5052A Measurement Screen” on page 36.
- Step 2.** Run the VBA program (procedure) using the following key sequence:
  - **[Macro Setup] - Select Macro**
- Step 3.** In the Macros dialog box (Figure 3-12), select the VBA program (procedure name) you want to run, and click the **OK** button.

Figure 3-12

### Macros dialog box

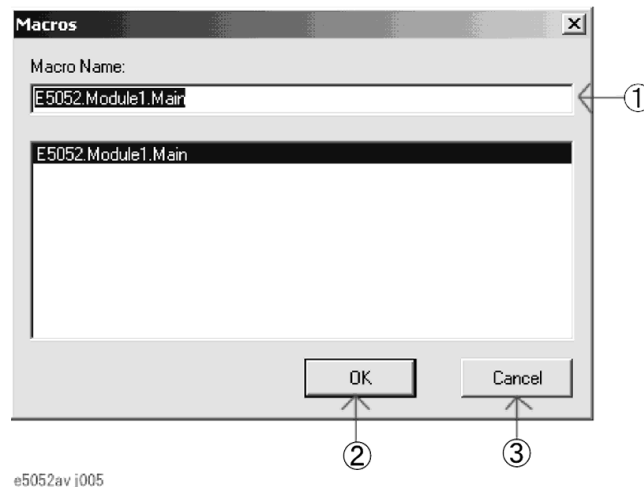

- 1. Macro Name:** Select the VBA program (procedure name) you want to run from the list box so its name appears here.
- 2. OK:** Clicking this button runs the selected VBA program (procedure).
- 3. Cancel:** Clicking this button closes the Macros dialog box and brings you back to the main screen.

---

#### NOTE

The Macros dialog provides access to subprograms without a parameter (procedures enclosed between **Sub( )** and **End Sub**) created in a standard module.

### Loading and executing program in batch process

---

#### NOTE

This feature is available for E5052A Rev. 1.50 or later.

This section describes how to load and execute a program (VBA project) in a batch process by pressing the softkey corresponding to the program name.

- Step 1.** Save the VBA program (VBA project file) into the following folder.

**F:\VBA**

---

**NOTE** This feature is available only for programs saved in F:\VBA. This feature is not available for programs saved in subfolders of F:\VBA.

---

**NOTE** When copying a VBA program to F:\VBA from another folder, copy all the files necessary to execute the program to appropriate folders. When copying a factory-installed VBA program into F:\VBA, choose only its VBA project file.

---

**Step 2.** Press **[Macro Setup] - Load & Run**.

**Step 3.** Press the softkey corresponding to the VBA project file name of the program you want to execute. The pressed VBA project is loaded and the program whose procedure name is set to "Main" (subprogram enclosed between Sub Main() and End Sub) and whose object name (Name property as displayed in the property window) is set to "Module" is executed.

---

**NOTE** When "Main" program of "Module1" doesn't exist, the "Illegal program name" error is displayed.

---

**NOTE** There is no limit to the number of VBA project files that can be saved in F:\VBA. However, the maximum number of programs that can be displayed as softkeys is 50.

---

- File names of the VBA projects saved in F:\VBA are displayed as softkeys in alphabetical order.
- The maximum number of characters that can be displayed in a softkey is 12. If a file name has 13 or more characters, "." is added to the 12th character from the beginning of the program name and displayed. In this case a .vba extension is omitted.

---

## Stopping a VBA Program

### Breaking a running macro via the dialog box

This section describes how to break a procedure during the execution of a VBA program by displaying the dialog box shown in Figure 3-13, which permits a forced interrupt.

**Step 1.** To break the running VBA program, do one of the following:

- On the **Run** menu, click **Break**.
- On the toolbar, click the "Break Macro" icon (Figure 3-2).
- Press **[Ctrl] + [Break]** on the keyboard.
- **[Macro Setup] - Stop** (E5052A measurement screen)
- Press the **[Macro Break]** key on the E5052A front panel.

**Step 2.** The dialog box shown in Figure 3-13 is displayed after the forced interrupt, and the program is suspended.

**Figure 3-13**

**Dialog box that appears when a VBA program is suspended**

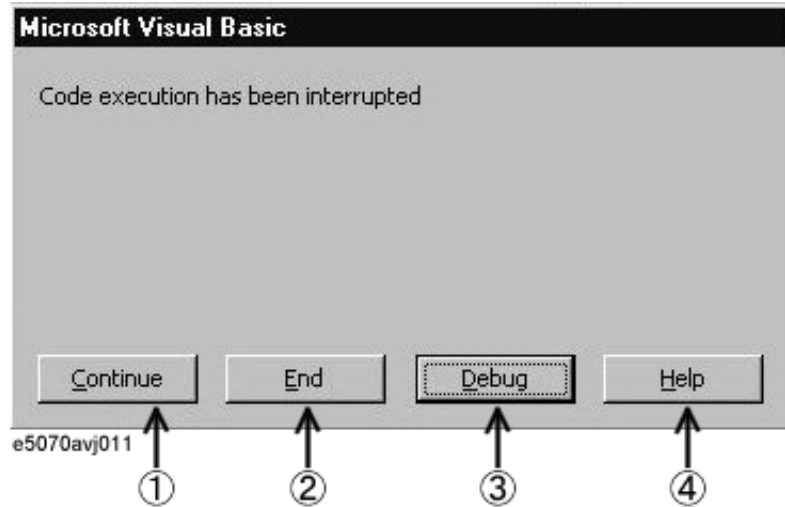

- 1. Continue:** Resumes the execution of the program.
- 2. End:** Terminates the VBA program.
- 3. Debug:** Displays a run-time error.
- 4. Help:** Brings up VBA Online Help.

### Abruptly terminating a VBA program

This section describes how to abruptly terminate a running procedure.

**Step 1.** To terminate the running VBA program, do one of the following:

- On the **Run** menu, click **Reset**.
- On the toolbar, click the “Reset Macro” icon (Figure 3-2).
- Insert an *End* statement into your code.

## Errors and Debugging

### Types of errors

Errors in VBA programs are classified as either syntax errors or run-time errors.

#### Syntax errors

A syntax error is generated when Visual Basic Editor detects an invalid statement that violates the Visual Basic syntax rules. For example, misspelled keywords generate syntax errors. An error dialog box appears that indicates the error message and highlights the invalid statement in red. To get detailed information on the error, click the HELP button in the error dialog box to display the help topic related to the error. You cannot run the macro until you correct the syntax error.

The E5052A VBA environment is by default configured to automatically check for syntax errors, but you can disable the auto syntax check feature by using the following steps:

- Step 1.** On the **Tools** menu, click **Options...**
- Step 2.** On the **Editor** tab, clear the **Auto Syntax Check** check box to remove the  mark.
- Step 3.** Click the **OK** button.

#### Run-time errors

A run-time error is generated when a VBA program attempts to execute an invalid statement at run time. When a run-time error is generated, the program is stopped at the invalid statement, and the error dialog box shown in Figure 3-13 appears. You can terminate the program by clicking the END button in the error dialog box. Also, you can click the DEBUG button in the error dialog box to identify the statement that caused the error. In this case, the statement in question is highlighted in yellow.

---

#### NOTE

Some run-time errors may occur under particular conditions, even though the program runs without error under normal conditions. For example, the “Marker search failed” error occurs when a program analyzing results while using the Marker Target Search feature fails to perform the search because the marker is not in the appropriate position. To avoid the interruption of a program due to such errors, you should handle these errors appropriately within the program.

---



### About the error evacuation at the time of execution

Below, the program which performs a target search is explained at an example.

- Line 20      An error processing routine when an error occurs is confirmed.
- Line 30      A target search is performed.
  - \*When an error occurs, a program is performed from the 80th line.
- Line 40      An error processing routine when an error occurs is repealed.
- Line 60      It slips out of the present sub program.
- Line 80      The place of an error processing routine is shown.
- Line 90      "Search Error" is displayed on a screen.
- Line 100     It goes back to the next line where the error occurred..

#### Example 3-1

#### The error evacuation program at the time of execution

```
10| Sub Main()  
20|   On Error GoTo SearchError  
30|   SCPI.CALCulate.FP.TRACe.MARKer.SEARCh.EXECute.TARGet  
40|   On Error GoTo 0  
50|  
60|   Exit Sub  
70|  
80| SearchError:  
90|   MsgBox "Search Error"  
100| Resume Next  
110| End Sub
```

## Using a debug tool

The E5052A's VBA environment provides a variety of debug tools to help you identify logical errors. Detailed information on using the debug tools is covered in the VBA Online Help and the wide selection of books on VBA.

### Debug toolbar

The debug toolbar (Figure 3-14) provides tool buttons that allow you to easily access various debug tools. To display the debug toolbar, do the following:

- Step 1.** On the **View** menu, click **Toolbars - Debug**.

Figure 3-14

### Debug toolbar

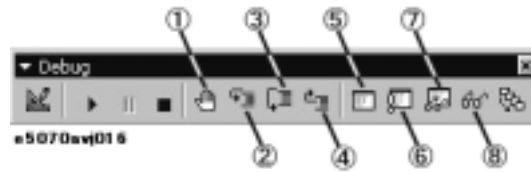

1. Set/clear break points (keyboard: [F9])  
Puts a break point at the cursor position or clears an existing break point.
2. Step-in (keyboard: [F8])  
Runs the VBA program step by step. If the current program contains a call to another procedure, that procedure is also run step by step.
3. Step-over (keyboard: [Shift]+[F8])  
Runs the VBA program step by step. If the current program contains a call to another procedure, that procedure is run as one line.
4. Step-out (keyboard: [Ctrl]+[Shift]+[F8])  
Executes the remaining lines of the function where the execution point is currently placed.
5. Local window  
Opens the local window that shows the current values of local variables.
6. Immediate window (keyboard: [Ctrl]+[G])  
Opens the immediate window that evaluates entered values of variables or expressions.
7. Watch window  
Opens the watch window that displays the current value of a specified expression.
8. Quick watch (keyboard: [Shift]+[F9])  
Displays the current value of a specified expression in a dialog box.

### Setting a break point

By placing a break point at a particular statement in a VBA program, you can automatically suspend the program when its execution reaches that statement.

- Step 1.** To set a break point as shown in Figure 3-15, do one of the following (when you put a break point at a line, the line is highlighted in amber):
- Place the cursor at the desired line of code, and click the “Set/clear break points” button (Figure 3-14: 1) on the debug toolbar.
  - Click anywhere in the margin indicator bar of the code window.

Figure 3-15

### Setting a break point



### Monitoring variable or property values

With your VBA program suspended, you can use the following debug tool to monitor variables or properties. To do this, you must set a break point, run the VBA program, and suspend it.

### Data Hint

When you point to the variable or expression of interest, Data Hint shows the current value, as shown in Figure 3-16.

Figure 3-16

### Data Hint

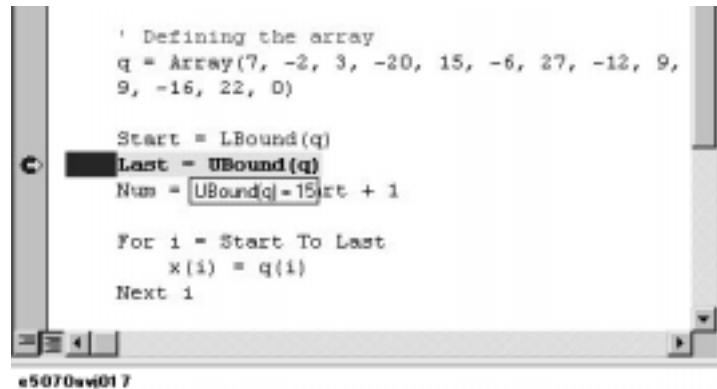

### Locals window

To display the immediate window, click the “Local Window” button (Figure 3-14:5) on the debug toolbar.

All the local variable values in the module under execution are displayed, as shown in Figure 3-17.

Figure 3-17

### locals window

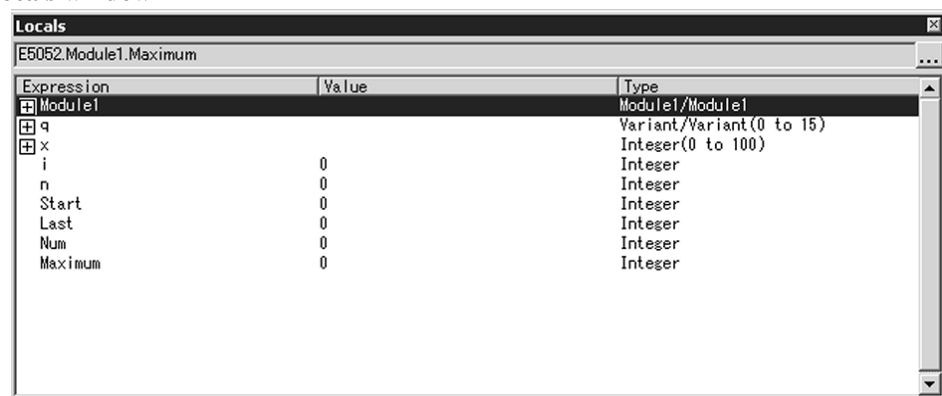

e5052avj017

### Immediate window

To display the immediate window, click the “Immediate Window” button (Figure 3-14:6) on the debug toolbar.

In the immediate window, enter a question mark (?) followed by the variable or expression whose value you want to check and then press the Enter key. The current value appears in the line that follows, as shown in Figure 3-18.

Figure 3-18

### Immediate window



### Watch window

To display the watch window (Figure 3-19), click the “Watch Window” button (Figure 3-14: 7) on the debug toolbar.

**Figure 3-19** Watch window

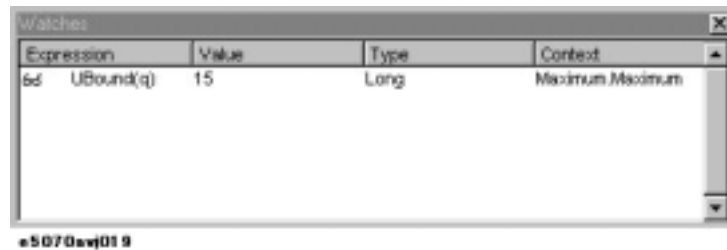

**Step 1.** To open the Add Watch dialog box (Figure 3-20), do the following:

- On the **Debug** menu, click **Add Watch....**

**Step 2.** As shown in Figure 3-20, you can specify an expression of interest as a watch expression to always monitor its value.

**Step 3.** Click the **OK** button.

**Figure 3-20** Add Watch dialog box

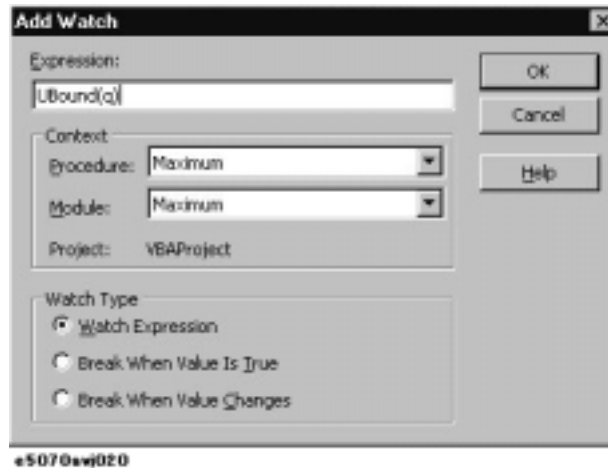

### Quick watch

In the code window, select a variable or expression whose value you want to watch. On the debug toolbar, click the “Quick Watch” button (Figure 3-14:8) to open the Quick Watch dialog box (Figure 3-21). The dialog box displays the current value of your specified variable or expression.

Also, you can click the **Add** button in the Quick Watch dialog box to specify the current expression as a watch expression.

Figure 3-21

### Quick watch



## **Printing Output Values in the Echo Window**

The echo window, which appears in the lower part of the E5052A measurement screen, can be used to display a message or the return value (data) of an object.

### **Entering values output to the echo window**

You can use the COM object shown below to enter values output in the echo window. For more information on each object, see Chapter 7, "COM Object Reference."

- **SCPI.DISPlay.ECHO.DATA** on page 239

### **Opening the echo window**

You can use the COM object shown below to open the echo window. For more information on each object, see Chapter 7, "COM Object Reference."

- **SCPI.DISPlay.ECHO.STATe** on page 240

Alternatively, you can also open the echo window by using the following key sequence:

- **[Macro Setup] - Echo Window Menu - Echo Window (ON)**

### **Clearing output values in the echo window**

You can use the COM object shown below to clear output values in the echo window. For more information on this object, see Chapter 7, "COM Object Reference."

- **SCPI.DISPlay.ECHO.CLEAr** on page 238

Alternatively, you can also clear output values in the echo window by using the following key sequence:

- **[Macro Setup] - Echo Window Menu - Clear Echo**

### **Changing character size in echo window**

You can use the COM object shown below to change the character size that appears in the echo window. For more information on this object, see Chapter 7, "COM Object Reference."

- **SCPI.DISPlay.ECHO.FSIZE** on page 239
- **[Macro Setup] - Echo Window Menu - Echo Font Size**



## Using VBA Online Help

VBA Online Help provides useful topics such as VBA terminology or how to use a particular feature. In VBA Online Help, you can find a topic of interest through the Contents tab or by entering specific keywords.

### Accessing VBA Online Help

**Step 1.** From Visual Basic Editor, do one of the following to access the VBA Online Help screen (Figure 3-22):

- On the **Help** menu, click **Microsoft Visual Basic Help**.
- Press **[F1]** on the keyboard.
- On the toolbar, click the “VBA Help” icon (Figure 3-2).

Figure 3-22

### VBA Online Help screen

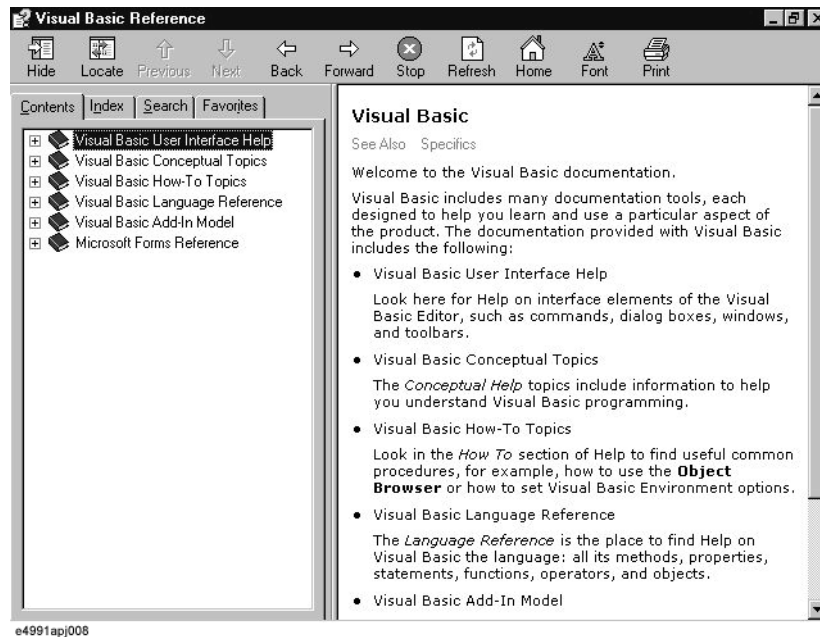

### Using the Contents Tab

**Step 1.** Clicking the **Contents** tab in the VBA Online Help screen brings up the items listed below. The E5052A VBA Online Help has a hierarchical table of contents. Click an item to expand it, and then find your particular topic of interest.

- Visual Basic User Interface Help
- Visual Basic Conceptual Topics
- Visual Basic How-To Topics
- Visual Basic Language Reference

## Operation Basics of the E5052A's VBA

### Using VBA Online Help

- Visual Basic Add-In Model
- Microsoft Forms Reference

When you need information on using Visual Basic Editor, use User Interface Help and How-To Topics as primary sources of information. Formats of VBA programs are covered in Visual Basic Conceptual Topics. Properties and methods supported by VBA are covered in Visual Basic Language Reference and Visual Basic Add-In Model. Information on using user forms is covered in Microsoft Forms Reference.

#### Using the Index Tab

- Step 1.** In the VBA Online Help screen, click the Index tab, and enter a keyword(s) into the text box. For example, you may wish to search for “Sub” or “With” when you are writing your own code.

#### Looking up a keyword in the code within Visual Basic Editor

When you want to know the usage or meaning of a keyword contained in a sample program or some other code, you can quickly access the help topic on that keyword by moving the cursor to the keyword and pressing **[F1]**.

## Using Advanced Techniques

### Accessing a list of E5052A COM objects

The VBA environment provides COM objects that support the user in controlling the E5052A. When you are developing a program using E5052A COM objects, you can access a list of E5052A COM objects by opening Object Browser within Visual Basic Editor.

**Step 1.** To open Object Browser, do one of the following:

- On the **View** menu, click **Object Browser**.
- On the toolbar, click the “Object Browser” icon (Figure 3-2).

**Step 2.** Select **E5052LIB** from the Project/Library box to display the E5052A library as shown in Figure 3-23.

#### NOTE

Some COM objects in the Object Browser’s list are **not** used for controlling the E5052A VBA; these COM objects are not described in the Chapter 7, “COM Object Reference.”

Figure 3-23

#### How to use Object Browser

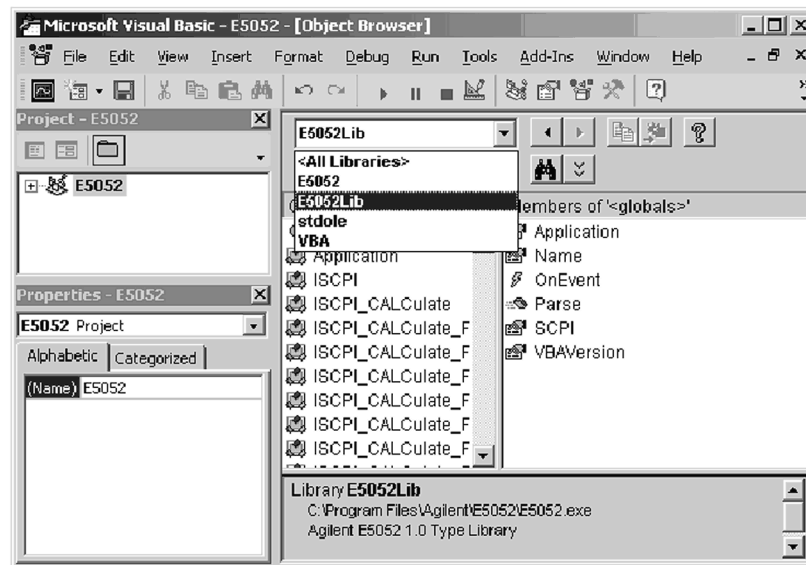

e5052avj042

## Using automatic library references

For libraries that satisfy the following conditions, the library reference will be automatically set whenever a new project is created and loaded ([Macro Setup] - VBA Editor Menu - New Project).

Automatically referenced libraries	Condition
Directory where the library resides.	F:\Agilent (F:\Agilent)
Extensions of libraries	olb, tlb, dll, or ocx

To check the library reference setting, you must use Visual Basic Editor.

Perform the following to check the library reference setting.

- On the **Tools** menu, click **References...**

The library reference setting is enabled if the library name is checked.

---

### NOTE

A project sets the library reference when the project is created. Therefore, if an existing project is loaded, libraries added after the development of the project are not automatically set in the library reference.

---

---

**4**

## **Controlling the E5052A**

This chapter explains how to use the E5052A's VBA to control the E5052A itself.

## Detecting End of Measurement

This section explains how to trigger the instrument to start a new measurement cycle and how to detect the end of a measurement cycle. For a detailed description of trigger detection, the trigger system, and the concept of triggering, see the Chapter on “Making a Measurement” in the *Programmer's Guide*.

You can detect the end of measurement by using either “Using the Status Register” on page 70 or “Using Event Interruption feature” on page 71.

---

**NOTE**

The OPC command can not detect the end of measurement.

### Using the Status Register

The status of the E5052A can be monitored through the status register. For a complete description of the status report mechanism, including the specifications of each bit of the status register, see the Appendix on “Status Reporting System” in the *Programmer's Guide*.

If your program is based on SPCI commands, you can use SRQ (Service Request) interrupts to detect the end of measurement. For more information, see the Section on “Waiting for the End of Measurement” in the *Programmer's Guide*.

The following is a sample program that demonstrates how to use an SRQ to detect the end of measurement.

In this program, you can start a measurement cycle by pressing the command button on the user form (cmdExec), and a message box will appear when the measurement finishes.

Line 40	The trigger continuous mode is turned “OFF”
Lines 50 to 60	The trigger system switches to "Idle" state and clears the operation status event register.
Lines 70 to 80	These lines configure the instrument so that operation status event register's bit 4 is set to 1 only when the operation status condition register's bit 4 is changed from 1 to 0 (negative transition).
Lines 100 to 120	The trigger source is set to “Bus Trigger” to start a measurement cycle.
Lines 140 to 170	These lines repeat until the end of measurement is detected.  Line 150: The control is returned to Windows so that other applications may be executed.
Line 190	A message box appears when the end of measurement is detected.

**Example 4-1****Using an SRQ to Detect the End of Measurement**

```
10| Private Sub cmdExec_Click()  
20|     Dim i As Long  
30|  
40|     SCPI.INITiate.SP.CONTinuous = False  
50|     SCPI.ABORT  
60|     SCPI.IEEE4882.CLS
```

```
70| SCPI.STATus.OPERation.PTRansition = 0
80| SCPI.STATus.OPERation.NTRansition = 16
90|
100| SCPI.TRIGger.SP.Source = "bus"
110| SCPI.INITiate.SP.CONTinuous = True
120| SCPI.IEEE4882.TRG
130|
140| Do While i = 0
150|     DoEvents
160|     i = SCPI.STATus.OPERation.EVENT
170| Loop
180|
190| MsgBox "end"
200|
210| End Sub
```

---

**NOTE**

The E5052A's VBA program is executed as a part of E5052A's applications. Therefore, if any executed VBA program takes a long time before returning control to Windows, all processing operations other than VBA are suspended during this time. To prevent this, use DoEvents to return the control to E5052A applications.

---

### Using Event Interruption feature

The E5052A provides an event interruption feature to allow you to detect the end of measurement. By enabling the E5052 Event softkey, you can obtain an end of sweep event.

For details, refer to the section on "Executing a Procedure with a Softkey (user menu function)" on page 76.

---

**NOTE**

To obtain an end of sweep event, you must create and execute a VBA program.

## Reading/Writing Measurement Data

This section describes how to process the E5052A's internal data. You can use these internal data arrays: unformatted data arrays, unformatted memory arrays, formatted data arrays, formatted memory arrays, and X-axis data arrays. For more information on the internal data arrays, see the section on "Internal Data Processing" in the *Programmer's Guide*.

To read/write a formatted data array, formatted memory array, unformatted data array, or unformatted memory array, use the following objects:

- SCPI.CALClate.xx.TRACe.DATA.FDATA
- SCPI.CALClate.xx.TRACe.DATA.FMEMory
- SCPI.CALClate.xx.TRACe.DATA.UDATa
- SCPI.CALClate.xx.TRACe.DATA.UMEMory

There are an unformatted data array and memory array where the phase noise measurement alone is contained with the unit of dBc.

- **SCPI.CALCulate.PN(1-1).TRACe(1-1).DATA.PDATa** on page 142
- **SCPI.CALCulate.PN(1-1).TRACe(1-1).DATA.PMEMory** on page 143

To read an X-axis data array, use the following object:

- SCPI.CALClate.xx.DATA.XDATa

For the transient measurement, you can use two types of object as follows.

- **SCPI.CALCulate.TR(1-1).NARRow.DATA.XDATa** on page 186
- **SCPI.CALCulate.TR(1-1).WIDE.DATA.XDATa** on page 209

To read a raw data array, use the following object:

- SCPI.CALClate.xx.DATA.RDATa

For the transient measurement, you can use two types of object as follows.

- **SCPI.CALCulate.TR(1-1).NARRow.DATA.RDATa** on page 185
- **SCPI.CALCulate.TR(1-1).WIDE.DATA.RDATa** on page 208

There is a raw array where the phase noise measurement alone is contained with the unit of dBc.

- **SCPI.CALCulate.PN(1-1).DATA.PDATa** on page 134

The E5052A VBA allows you to deal with multiple pieces of data through variables of the Double-precision Dynamic Array type. For example, a formatted data array that includes five measurement points is stored as shown in Figure 4-1. For more information on contained data, see the section on "Reading/Writing Measurement Data" in the *Programmer's Guide*.



Figure 4-1 Example of storing data into a Variant variable

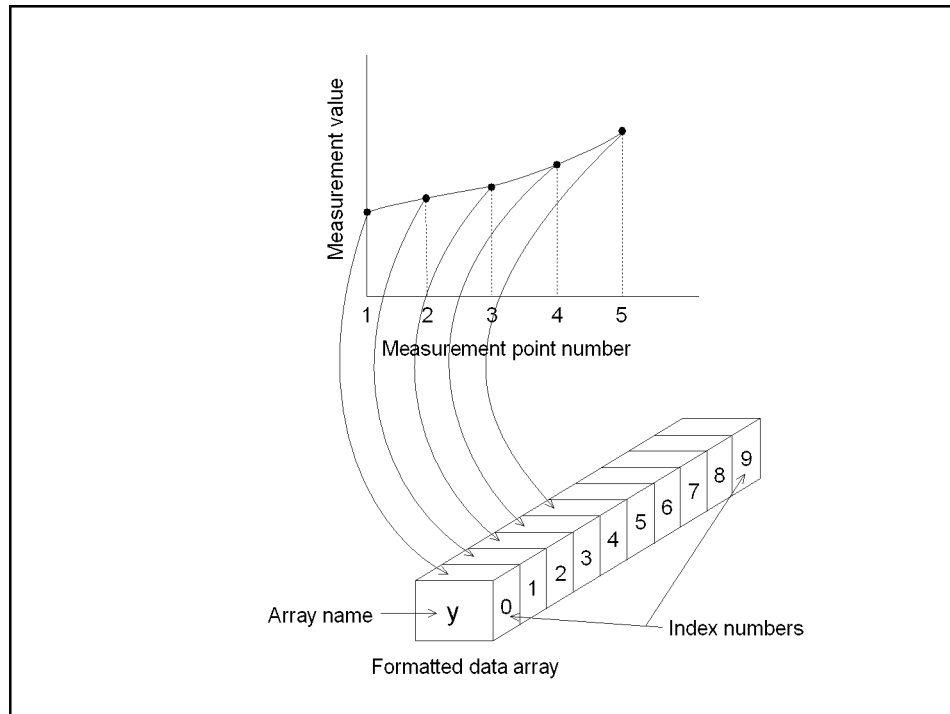

e5052ave038

**NOTE** When you use one of the objects listed above, the base index number of the array is always 0 even if the declaration section contains the "Option Base 1" statement, which specifies the use of the base array index of 1.

---

## Limit Test

This section describes how to define the limit lines and determine pass or fail with regard to the limit test function. For more on the concept of the limit test, refer to the Chapter describing “Data Analysis and Result Output” in the User’s Guide.

### Using Commands to define Limit Lines

You can define the limit lines by specifying any limit value to the parameter of SCPI commands.

The program is described in detail below:

Line 20 to 30	Define the data array (variable) for the limit lines.
Line 40 to 50	Redefine the data array (variable) depending on the number of limit lines (segments).
Line 70 to 140	Set the upper limit value for the limit lines in the array.
Line 160 to 190	Set the lower limit value for the limit lines in the array.
Line 220 to 230	Specify the segment number for the upper and lower limit values.
Line 250 to 260	Specify the upper and lower limit values on the trace.
Line 280 to 320	Trigger the instrument.
Line 340	Display the limit lines.
Line 350	Display the determination result. (For fail only.)
Line 360	Activate the limit test function.

#### Example 4-2

#### Using Commands to define Limit Lines

```
10| Sub Main()  
20|   Dim Udata() As Double  
30|   Dim Ldata() As Double  
40|   ReDim Udata(7)  
50|   ReDim Ldata(3)  
60|  
70|   Udata(0) = 0  
80|   Udata(1) = 1400000000#  
90|   Udata(2) = 0.00002  
100|  Udata(3) = 1400000000#  
110|  Udata(4) = 0.00002  
120|  Udata(5) = 1600000000#  
130|  Udata(6) = 0.0001  
140|  Udata(7) = 1600000000#  
150|  
160|  Ldata(0) = 0  
170|  Ldata(1) = 1200000000#  
180|  Ldata(2) = 0.0001  
190|  Ldata(3) = 1200000000#  
200|  
210|  SCPI.DISPLAY.WINDOW.ACTive = "FP1"  
220|  SCPI.CALCulate.FP.TRACe.LIMit.UPPer.SEGMent.Count = 2  
230|  SCPI.CALCulate.FP.TRACe.LIMit.LOWer.SEGMent.Count = 1
```

```

240|
250|     SCPI.CALCulate.FP.TRACe.LIMit.UPPer.SEGment.DATA = Udata
260|     SCPI.CALCulate.FP.TRACe.LIMit.LOWer.SEGment.DATA = Ldata
270|
280|     SCPI.TRIGger.MODE = "FP1"
290|     SCPI.TRIGger.FP.Source = "bus"
300|     SCPI.INITiate.FP.CONTInuous = False
310|     SCPI.INITiate.FP.IMMEDIATE
320|     SCPI.IEEE4882.TRG
330|
340|     SCPI.DISPlay.FP.TRACe.LIMit.LINE = True
350|     SCPI.DISPlay.FP.LIMit.FSIGN = True
360|     SCPI.CALCulate.FP.TRACe.LIMit.STATe = True
370| End Sub

```

### Reading Limit Lines from Files

You can create any upper and lower value for limit lines in the specified format in advance, and read the file later to specify the limit lines.

For information about creating upper and lower values for limit lines, refer to the chapter describing “Data analysis and Result Output” in the User’s Guide.

The file must be saved in the CSV format (with the extension \*.csv).

The program is described in detail below:

---

**NOTE** Save the upper limit values together into one file, and the lower limit values into another.

---

Line 20	Read the lower limit value for the limit lines from the file.
Line 30	Read the upper limit value for the limit lines from the file.
Line 50 to 100	Trigger the instrument.
Line 120	Display the limit lines.
Line 130	Display the determination result. (For fail only.)
Line 140	Activate the limit test function.

#### Example 4-3

#### Reading Limit Lines from File

```

010| Sub Main()
020|     SCPI.MMEMory.FP.TRACe.LoAd.LIMit.LOWer = "f:\lower.csv"
030|     SCPI.MMEMory.FP.TRACe.LoAd.LIMit.UPPer = "f:\upper.csv"
040|
050|     SCPI.DISPlay.WINDow.ACTive = "FP1"
060|     SCPI.TRIGger.MODE = "FP1"
070|     SCPI.TRIGger.FP.Source = "bus"
080|     SCPI.INITiate.FP.CONTInuous = False
090|     SCPI.INITiate.FP.IMMEDIATE
100|     SCPI.IEEE4882.TRG
110|
120|     SCPI.DISPlay.FP.TRACe.LIMit.LINE = True
130|     SCPI.DISPlay.FP.LIMit.FSIGN = True
140|     SCPI.CALCulate.FP.TRACe.LIMit.STATe = True
150| End Sub

```

## Executing a Procedure with a Softkey (user menu function)

The E5052A lets you perform procedures assigned to specific softkeys (**[Macro Setup] - User Menu - User Label 1/2/3/4/5/6/7/8**) without using user forms for the event activated by pressing the softkey. This function is called the user menu function.

---

**NOTE**

You must create and execute a VBA program when using the user menu function.

## Preparing to use the User Menu Function

Before using the user menu function, perform the following preparation.

### Settings for Softkey Label Name

When you want to change the softkey label names for the user menu function, you need to code within the VBA program. For details, refer to “Sample Program of Settings for Softkey Label and Softkey Enabled/Disabled (object name: Module1)” on page 78.

For more information on this object, see Chapter 7, “COM Object Reference.”

- **SCPI.PROGram.SKEY.ITEM(1-8).LABel** on page 305

### Enabling/Disabling Softkey

When you want to enable or disable the softkey for the user menu function, you need to code within the VBA program. For details, refer to “Sample Program of Settings for Softkey Label and Softkey Enabled/Disabled (object name: Module1)” on page 78. For more information on this object, see Chapter 7, “COM Object Reference.”

Use the following COM objects to enable or disable the softkey. For more information on this object, see Chapter 7, “COM Object Reference.”

- **SCPI.PROGRAM.SKEY.ITEM(1-8).ENABLE** on page 304

### How to use the User Menu Function

To execute the procedure assigned to a softkey, you need to generate an event by pressing the softkey.

For this, you need to code within the VBA program to execute a procedure. For more information, refer to “Sample Program Executing User Menu (object name: Class1)” on page 79.

Use the following function to execute a procedure in the user menu.

**Step 1.** Enable the softkey to generate an event.

- **[Macro Setup] - E5052 Event ON**

**Step 2.** Press the softkey.

- **[Macro Setup] - User Menu - User Label No.**

“**No.**” represents the button number. You can set the label for “**User Label No.**” as you like. For details, refer to the “Enabling/Disabling Softkey.” section.

---

#### NOTE

You can use the user menu function only when the VBA program is running. For information on how to verify whether the VBA is running, refer to “Running a VBA Program” on page 51.

---

**Simple usage example**

The following is a simple example that uses a standard module and a class module.

**Table 4-1**

Object name	Module type	Function
Module1	Standard module	Sets the softkey labels and enables interrupts from the softkeys
Class1	Class module	Specifies the processing to be followed when an event occurs

The program (object name: Module1) is described in detail below:

Line 60	The instance of the class module specified by Class1 is assigned to clsEvent (Object creation).
Lines 80 to 140	Set the first and second softkey ( <i>id</i> : 1 to 2) to enabled and set the third to eighth softkey ( <i>id</i> : 3 to 8) to disabled.
Lines 160 to 170	Set the first softkey label ( <i>id</i> : 1) to "Preset" and the second softkey label ( <i>id</i> : 2) to "Exit".
Lines 190 to 210	Processing repeated until the event occurs.
Line 200	Detects an event when a specific softkey is pressed and enables the interrupt from the event.

**Example 4-1****Sample Program of Settings for Softkey Label and Softkey Enabled/Disabled (object name: Module1)**

```

10| Sub Main()
20|
30|   Dim clsEvent As Class1
40|   Dim I As Long, J As Long
50|
60|   Set clsEvent = New class1
70|
80|   For I = 1 To 2
90|     SCPI.PROGram.SKEY.Item(I).ENABLE = True
100|  Next I
110|
120|   For J = 3 To 8
130|     SCPI.PROGram.SKEY.Item(J).ENABLE = False
140|  Next J
150|
160|   SCPI.PROGram.SKEY.Item(1).LABEL = "Preset"
170|   SCPI.PROGram.SKEY.Item(2).LABEL = "Exit"
180|
190|   Do
200|     DoEvents
210|   Loop
220|
230|   Set clsEvent = Nothing
240|
250| End Sub

```

## Executing a Procedure with a Softkey (user menu function)

The program (object name: Class1) is described in detail below:

- Lines 50 to 130    An event occurs when the softkey is pressed from the user menu.
- Lines 70 to 80: E5052A are reset to the initial setting when the first softkey is pressed.
- Lines 90 to 120: The program ends with a message box displayed when the second softkey is pressed.
- Lines 140 to 150    An event occurs when the triggered sweep ends.
- Line 150: A message box appears when the sweep ends.
- Lines 190 to 210    Implement the object.
- Lines 230 to 250    Release the object.

**Example 4-2****Sample Program Executing User Menu (object name: Class1)**

```

10| Dim WithEvents app As Application
20|
30| Private Sub app_OnEvent(ByVal ReasonStr As String, ByVal
OptionStr As String)
40|     Select Case ReasonStr
50|         Case "UserLabel"
60|             Select Case OptionStr
70|                 Case 1
80|                     SCPI.SYSTem.PRESet
90|                 Case 2
100|                    SCPI.PROGram.COM.EVENT = False
110|                    MsgBox "Program ended"
120|                End
130|            End Select
140|        Case "SweepEnd"
150|            MsgBox "Sweep ended"
160|    End Select
170| End Sub
180|
190| Private Sub Class_Initialize()
200|     Set app = Application
210| End Sub
220|
230| Private Sub Class_Terminate()
240|     Set app = Nothing
250| End Sub

```

**NOTE**

The E5052A's VBA program is executed as a part of E5052A's applications. Therefore, if any executed VBA program takes a long time before returning control to Windows, all processing operations other than VBA are suspended during this time. To prevent this, use DoEvents to return the control to E5052A applications.

**Argument for event occurrence**

The arguments for event occurrence are described below. An event represents `app_OnEvent`, which is described in Example 4-2 of the “Simple usage example”.

**Table 4-2**

<b>Event</b>	<b>First argument</b>	<b>Second argument</b>
User menu	UserLabel	Softkey label NO. (1-8)
End of sweep	SweepEnd	Measurement window (FP/PN/SP/TR/USER)
Request for service	RQS	Nothing

**NOTE**

`OnEvent(id1 As String, id2 As String)` is a event handler of the events from the application and can refer to the instance (data) of the class. By declaring the object a variable “app” in the class module, it can be utilized as a procedure to obtain the event occurrence.

Within the event handler (lines 30-170), the processing should be the minimum necessary before an event ends. Nesting is also not allowed.



---

## Controlling VBA Externally

This section describes how to control the E5052A's VBA externally.

### Executing VBA Using External Controller

You can execute VBA from an external PC by running either macros or the user menu.

#### Running Macro

To start VBA from an external PC, use the following command:

- **SCPI.MMEMory.LOAD.PROG**ram on page 293
- **SCPI.PROG**ram.COM.EVENt on page 303
- **SCPI.PROG**ram.SELected.STATe on page 304

#### Running User Menu

To execute the user menu from an external PC, use the following command: This command executes the first of the menu.

To execute the user menu, you must execute the user menu function in advance. For more information, refer to “Running User Menu” on page 81.

- **SCPI.PROG**ram.SKEY.Item(1).IMMediate

### Receiving the Termination of VBA Using External Controller

To allow the external controller to receive the termination of VBA from the E5052A, you may either confirm the operational status of VBA or use the user-defined register.

#### Confirming VBA's Operational Status

To confirm the operational status of VBA, use the following command:

- **SCPI.PROG**ram.SELected.STATe on page 304

#### Using User-defined Register

To use the user-defined register, use the following command: For more information, refer to “Using User-defined Register” on page 82.

- **SCPI.STAT**us.OPERation.BIT12.CLEAr on page 341
- **SCPI.STAT**us.OPERation.BIT12.CONDition on page 341
- **SCPI.STAT**us.OPERation.BIT12.ENABLE on page 341
- **SCPI.STAT**us.OPERation.BIT12.EVENt on page 342
- **SCPI.STAT**us.OPERation.BIT12.NTRansition on page 342
- **SCPI.STAT**us.OPERation.BIT12.PTRansition on page 342
- **SCPI.STAT**us.OPERation.BIT12.SET on page 343

## Using User-defined Register

The E5052A does not control the individual status flag of the user-defined register. In order to start the E5052A VBA using the external controller to obtain the end bit, the user must make the user-defined register to be controlled within the program.

The user can assign any register number to the user-defined register which he/she wants to use. Available register numbers are 1 to 15 (0 to 14 bit).

If you use the user-defined register, you must specify the same register number for both the external controller side and the E5052A's program side. (Figure 4-2)

Figure 4-2

Reference of User-defined Register

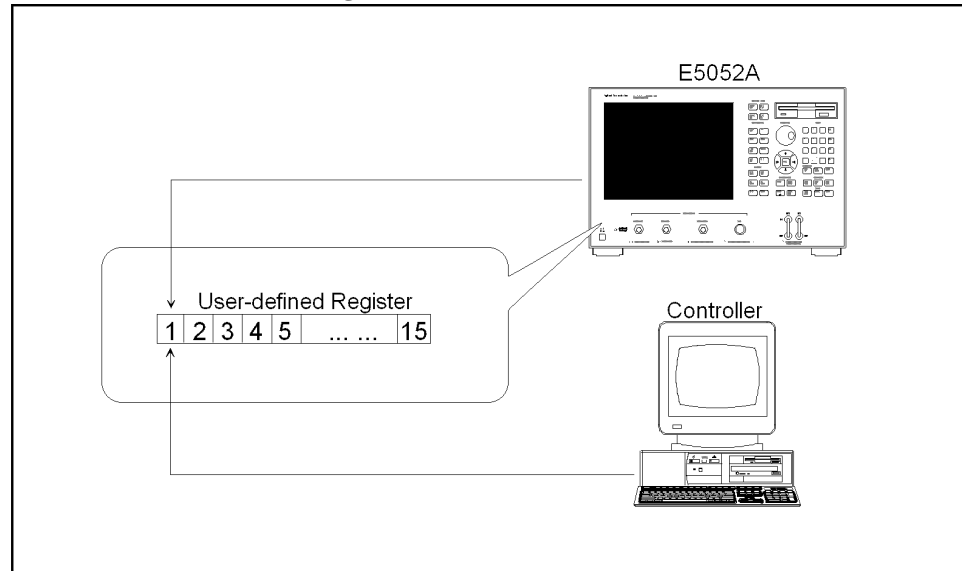

e5052ave010

The following is a sample program.

- (1) Clears the first condition register to be used (bit 0).
- (2) These lines configure the instrument so that the operation use-defined status event register's bit 0 is set to 1, when the operation use-defined condition register's bit 0 is changed from 0 to 1 (i.e. positive transition).
- (3) Executes the user menu.
- (4) Repeats until the termination of VBA is detected.

Figure 4-3 A Sample Program to Control User-defined Register (On the Controller Side)

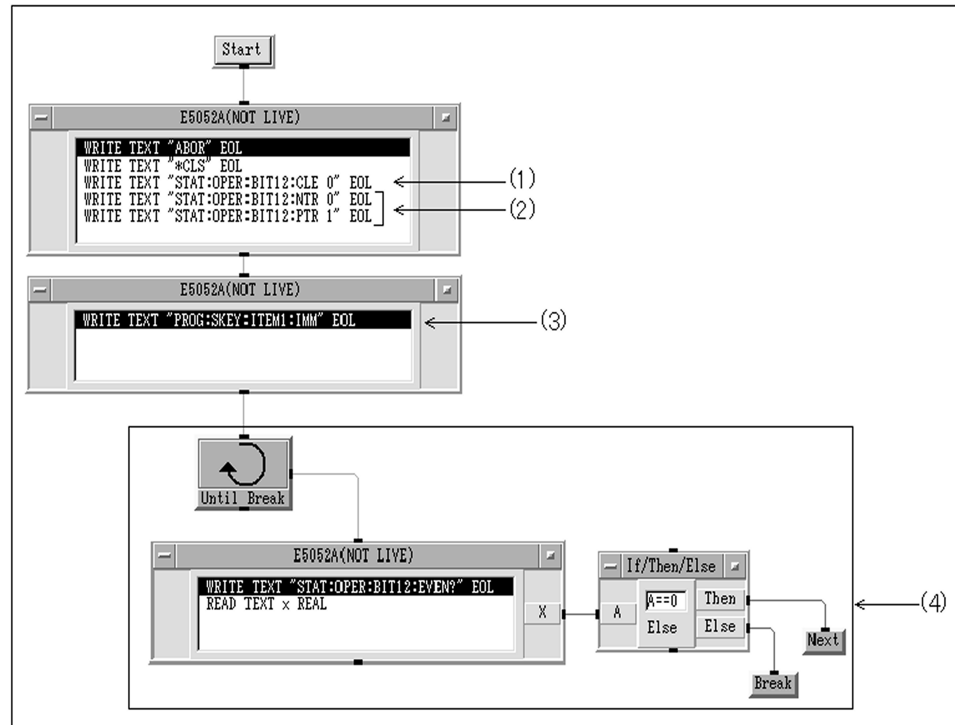

e5052avj011

- Lines 30 to 90 An event occurs when the softkey is pressed from the user menu.
  - Lines 50 to 60: E5052A will be reset to the initial setting, when the first softkey is pressed.
  - Lines 70 to 80: The message box will appear, when the second softkey is pressed.
- Lines 100 to 110 An event will occur when the triggered sweep ends.
  - Line 110: A message box will appear when the sweep ends.
- Line 130 Sets a flag to the first of the user-defined register (bit 0).
- Line 140 This procedure terminates the program.

**Example 4-1 A Sample Program to Control User-defined Register (On the E5052A Side)**

```

10|Private Sub app_OnEvent(ByVal ReasonStr As String, ByVal
OptionStr As String)
20|    Select Case ReasonStr
30|        Case "UserLabel"
40|            Select Case OptionStr
50|                Case 1
60|                    SCPI.SYSem.PRESet
70|                Case 2
80|                    MsgBox "Program ended"
90|            End Select
100|        Case "SweepEnd"
110|            MsgBox "Sweep ended"
120|    End Select

```

4. Controlling the E5052A

## Controlling the E5052A

### Controlling VBA Externally

```
130 | SCPI.STATus.OPERation.BIT12.SET = 0  
140 | End  
150 | End Sub
```

---

**NOTE**

---

For more information on the user-defined register, refer to the status reporting system described in the appendix of the programmer's guide

## Using User-defined Variables

The E5052A has an area for which the users may set any value. The areas are divided for each data type.

An area can be used up to 10 (1 to 10) for each command.

The values set by a command cannot be removed by executing preset.

- **SCPI.PROGram.VARiable.ARRay(1-10).DATA** on page 305
- **SCPI.PROGram.VARiable.ARRay(1-10).POINTs** on page 305
- **SCPI.PROGram.VARiable.DOUBle(1-10)** on page 306
- **SCPI.PROGram.VARiable.INTeger(1-10)** on page 306
- **SCPI.PROGram.VARiable.STRING(1-10)** on page 307

### NOTE

These commands do not refer to or change the results within the E5052A.

The following is a sample program for configuration, which demonstrates how to use the floating-point-formatted user-defined array.

Line 30 to 50	Define the variables.
Line 70	Assign values to the variables.
Line 90	Call the function to trigger the instrument.
Line 110	Configure marker X for frequency measurement (trace 1).
Line 120	Read out marker Y for frequency measurement (trace 1).
Line 130	Configure marker X for power measurement (trace 2).
Line 140	Read out marker Y for power measurement (trace 2).
Line 160	Set the value of marker Y for frequency measurement at the beginning of the user-defined array.
Line 170	Set the value of marker Y for power measurement to that of the 2nd dimension of the user-defined array.

### Example 4-2

#### How to use floating point formatted user-defined array

```

10| Sub Main()
20|
30|   Dim Vcc1 As Double
40|   Dim FP_Freq As Double
50|   Dim FP_Power As Double
60|
70|   Vcc1 = 0.5
80|
90|   Call FP_SingleSweep
100|
110|   SCPI.CALCulate.FP.Trace(1).MARKer(1).X = Vcc1
120|   FP_Freq = SCPI.CALCulate.FP.Trace(1).MARKer(1).Y
130|   SCPI.CALCulate.FP.Trace(2).MARKer(1).X = Vcc1
140|   FP_Power = SCPI.CALCulate.FP.Trace(2).MARKer(1).Y
150|

```

## Controlling the E5052A

### Controlling VBA Externally

```
160| SCPI.PROGRAM.VARIABLE.DOUBLE(1) = FP_Freq
170| SCPI.PROGRAM.VARIABLE.DOUBLE(2) = FP_Power
180| End Sub
```

The following sample program demonstrates how to use the array-formatted user-defined array.

Line 30 to 50	Define the variables.
Line 70	Call the function to trigger the instrument.
Line 90	Read out the number of points and set it to the variable.
Line 100 to 110	Redefine the array (variable).
Line 130	Read out the trace data and set it to the variable.
Line 140	Read out the X-axis data and set them to the variable.
Line 160	Specify the number of data points at the beginning of the user-defined array.
Line 170	Specify the trace data at the beginning of the user-defined array.
Line 190	Specify the number of data points to that of the 2nd dimension of the user-defined array.
Line 200	Specify the X-axis data to that of the 2nd dimension of the user-defined array.

#### Example 4-3

#### How to use the array formatted user-defined array

```
10| Sub Main()
20|
30| Dim PN_Nop As Long
40| Dim PN_Trace() As Double
50| Dim PN_Freq() As Double
60|
70| Call PN_SingleSweep
80|
90| PN_Nop = SCPI.SENSE.PN.SWEEP.POINTS
100| ReDim PN_Trace(PN_Nop - 1)
110| ReDim PN_Freq(PN_Nop - 1)
120|
130| PN_Trace = SCPI.CALCULATE.PN.TRACE.DATA.FDATA
140| PN_Freq = SCPI.CALCULATE.PN.DATA.XDATA
150|
160| SCPI.PROGRAM.VARIABLE.ARRAY(1).POINTS = PN_Nop
170| SCPI.PROGRAM.VARIABLE.ARRAY(1).DATA = PN_Trace
180|
190| SCPI.PROGRAM.VARIABLE.ARRAY(2).POINTS = PN_Nop
200| SCPI.PROGRAM.VARIABLE.ARRAY(2).DATA = PN_Freq
210|
220| End Sub
```

---

## **5** **User Defined Window**

## **Overview**

The E5052A's user defined window provides graphics utility for tailoring the measurement and interpreting the results. Users can operate scale, trace, and marker functions as same as that of E5052A's other instrument mode.



---

## How to use the User Defined Window

This section explains how to use the user defined window on the E5052A.

### Printing Measurement Data in the User Define Window

The E5052A's user defined window enables the display traces by copying the data array to the trace array of the user defined window. Users can access all the data array of the user defined window via either VBA COM commands or SCPI commands. Up to 8 traces can be displayed in the E5052A's user defined window.

The example 5-1 shows a sample procedure that demonstrates how to display traces that users define data array both in X-axis and Y-axis.

Lines 20 to 30	Defines data array to be displayed in the trace of user defined window.
Line 50	Selects and specifies the user defined window as active window.
Lines 80 to 90	Copies formatted data trace from the frequency-power measurement results to the data array defined in the VBA program.
Line 110	Specifies trace 1 as active trace
Line 140	Copies data array to X-axis data on trace 1
Line 170	Copies data array to Y-axis data on trace 1
Lines 200 to 210	Sets display unit of X-axis and Y-axis respectively.
Line 240	Execute autoscale
Line 260	Returns to the E5052A application

User Defined Window  
How to use the User Defined Window

**Example 5-1**      **Measurement Data in the User Define Window**

```
10| Sub Main()  
20|   Dim aryXdata() As Double  
30|   Dim aryYdata() As Double  
40|  
50|   SCPI.DISPlay.USER.STATe = True  
60|   SCPI.DISPlay.WINDow.ACTive = "USER1"  
70|  
80|   aryXdata = SCPI.CALCulate.FP.DATA.XDATA  
90|   aryYdata = SCPI.CALCulate.FP.TRACe(1).DATA.FDATA  
100|  
110|   SCPI.DISPlay.USER.TRACe(1).STATe = True  
120|  
130|   'x data  
140|   SCPI.CALCulate.USER.TRACe(1).DATA.XDATA = aryXdata  
150|  
160|   'y data  
170|   SCPI.CALCulate.USER.TRACe(1).DATA.FDATA = aryYdata  
180|  
190|   'Unit  
200|   SCPI.DISPlay.USER.TRACe(1).X.UNIT = "V"  
210|   SCPI.DISPlay.USER.TRACe(1).Y.UNIT = "Hz"  
220|  
230|   'Auto scale  
240|   SCPI.DISPlay.USER.ALLTrace.Y.SCALe.AUTO  
250|  
260|   DoEvents  
270|  
280| End Sub
```

---

**NOTE**      The E5052A's VBA program is executed as an application. Therefore, if any executed VBA program takes a long time before returning control to the E5052A, all processing operations other than VBA are suspended during this time. To prevent this, use DoEvents to return the control to the E5052A.

---

**NOTE**      The value in the X-data array for the user defined window has to have incremental order, that means (the value at N point) < (the value at N+1 point). When the error message, "Illegal parameter value" is received, check the values of the X-data array data on point-to-point to ensure this rule.

---

Figure 5-1

Example of display to User Define Window

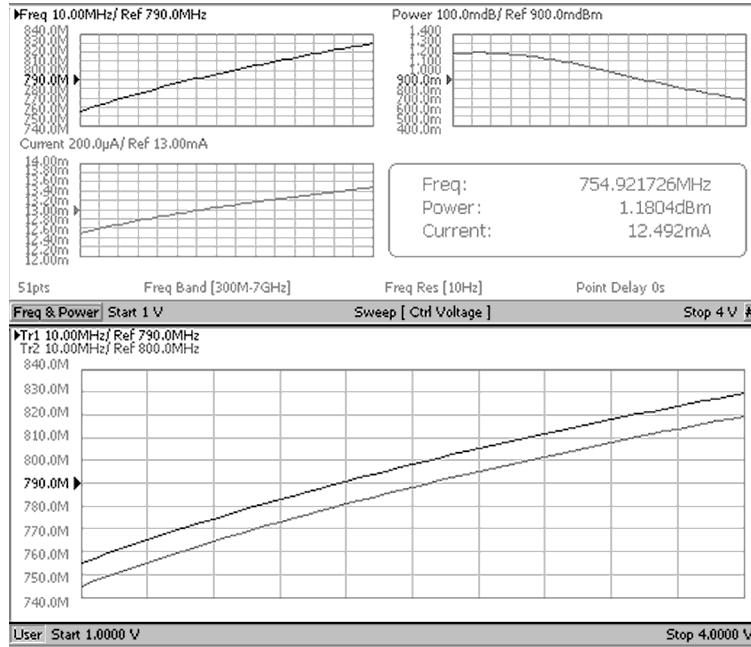

e5052avj015

## **Analysis Functions and Save/Recall Functions**

- Analyzing Data on the Trace Using the Marker
- Searching for Positions that Match Specified Criteria
- Determining the Mean, Standard Deviation, and p-p of the Trace
- Comparing Traces
- Performing Data Math
- Saving and Recalling Instrument State
- Saving Trace Data to a File

---

## **6** Controlling Peripherals

This chapter explains how to control peripherals connected to the E5052A with GPIB by using the software (VISA library) installed in the E5052A.

## Overview

The E5052A macro function (E5052A VBA) can be used not only to automate measurements but also to control external measurement instruments connected via the USB/GPIB interface cable by acting as a self-contained system controller (see "Overview of Control System Based on Macro Function" on page 29).

The E5052A macro function (E5052A VBA) performs communications via the COM interface when controlling the E5052A itself, but it communicates via VISA (Virtual Instrument Software Architecture) when controlling external measurement instruments.

To control peripherals connected to the E5052A via the USB/GPIB interface cable, the following preparation is required.

## Preparation

### Importing definition files

To use the VISA library in the E5052A macro (E5052A VBA), you need to import two definition files into your project with the Visual Basic editor to define the VISA functions and perform other tasks. You can find the source file of this program saved under the following name on the sample program disk. For importing the module, see "Loading a module (importing)" on page 49

- visa32.bas
- vpptype.bas

## Programming with VISA

Figure 6-1 shows the flow of controlling the instrument with VISA. When developing a VISA program in the Visual Basic language, a special programming notice (in the readme text file listed below) must be reviewed.

For details on the use of the VISA library and the programming notice for using the VISA library with the E5052A macro (E5052A VBA), refer to the following files on the CD-ROM (Agilent part number: E5052-9050x).

- visa.hlp (on-line help for the VISA library)
- vbreadme.txt (notes on using the VISA library with VB)

**NOTE** The number position shown by “x” in the part numbers above indicates the edition number.

**Figure 6-1** Flow of instrument control with VISA

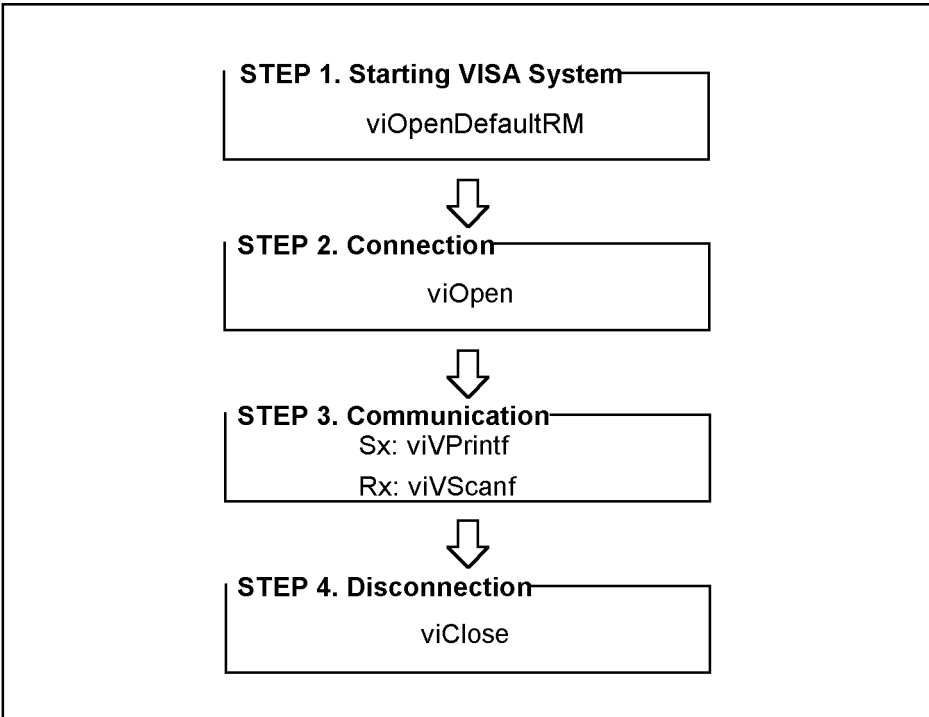

e4991ape033

## STEP 1. Starting Up VISA System

VISA's viOpenDefaultRM function initializes and starts up the VISA system. The function viOpenDefaultRM should always be used when initiating VISA functions. The parameter of this function is startup information.

### Syntax

viOpenDefaultRM(*param*)

### Parameter

	<i>param</i>
Description	Startup information (output)
Data type	Long integer type

## STEP 2. Connection

VISA's viOpen function makes connection with the specified instrument. The viOpen function returns a value so that the VISA functions can apply it to the specified instrument. The parameters of this function are startup information, the address information of the specified instrument, access mode, timeout, and connection information.

### Syntax

viOpen(*param1*, *param2*, *param3*, *param4*, *param5*)

### Parameter

	<i>param1</i>
Description	Startup information (input)
Data type	Long integer type

	<i>param2</i>
Description	Address information of specified instrument (input)
Data type	Character string type
Syntax	GPIB[ <i>board</i> ] <sup>*1</sup> :: <i>primary address</i> <sup>*2</sup> ::INSTR

\*1. GPIB0 for E5052A

\*2. GPIB address of instrument controlled by E5052A

	<i>param3</i>
Description	Access mode (Enter 0)

	<i>param4</i>
Description	Timeout (Enter 0)



	<i>param5</i>
Description	Connection information (output)
Data type	Long integer type

### STEP 3. Communication

VISA's viVPrintf function sends a program message (GPIB command) to the specified instrument. The parameters of this function are connection information, the program message, and the variable to be formatted.

#### NOTE

To input/output GPIB commands, the viVPrintf function and the viVScanf function are mainly used, but other VISA functions are also available. For more information, refer to visa.hlp (online help for the VISA library).

#### Syntax

viVPrintf(*param1*,*param2*,*param3*)

#### Parameter

	<i>param1</i>
Description	Connection information (input)
Data type	Long integer type

	<i>param2</i>
Description	Program message (input)*1
Data type	Character string type

\*1. When sending a program message of the GPIB command, a message terminator is required at the end of the message.

	<i>param3</i>
Description	A variable to be formatted*1
Data type	Specified data type

\*1. If not applicable, enter 0.

VISA's viVScanf function receives the result from the specified instrument and stores it in the output variable. The parameters of this function are connection information, the format parameter for the output variable, and the output variable.

#### Syntax

viVScanf(*param1*,*param2*,*param3*)

**Parameter**

	<i>param1</i>
Description	Connection information (input)
Data type	Long integer type

	<i>param2</i>
Description	Format parameter for output variable
Data type	Character string type

	<i>param3</i>
Description	Output variable (output)
Data type	Character string type

**STEP 4. Disconnection**

VISA's viClose function disconnects communication and terminates the VISA system. The parameter of this function is startup information.

**Syntax**

viClose(*param*)

**Parameter**

	<i>param</i>
Description	Startup information (input)
Data type	Long integer type

---

**7****COM Object Reference**

This chapter describes the COM object model of the Agilent E5052A and the COM object reference in alphabetical order. If you want to look up COM objects by corresponding front panel keys, see “COM object list by front panel key.”

## COM Object Model

The COM objects provided for the E5052A are structured hierarchically as shown in Figure 7-1.

Figure 7-1

E5052A COM object model

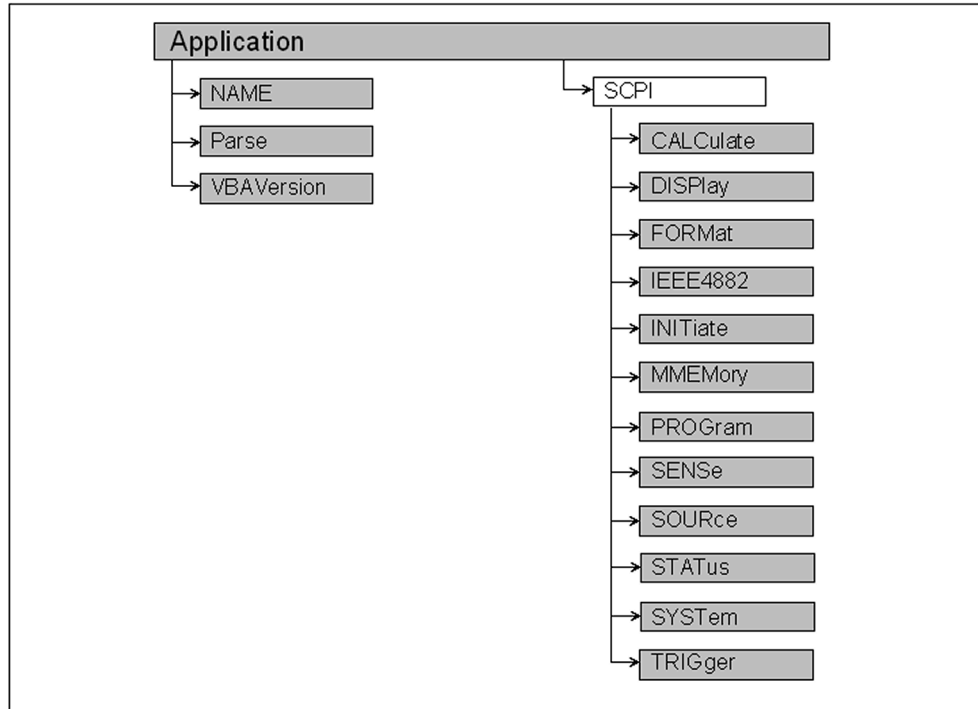

e5052awj012

## Application Objects

The Application objects are at the top of the hierarchy of the E5052A COM object model. They consist of 3 objects dedicated to the COM interface and SCPI objects corresponding to SCPI commands. For information on the basic use of the 3 objects dedicated to the COM interface, see “Application Objects” on page 100.

## SCPI Objects

The SCPI objects are created to realize the SCPI commands of the E5052A with the COM interface. For information on the basic use of the SCPI objects, see “SCPI Objects” on page 101.

The conversion rules from the SCPI commands when writing SCPI object messages are as follows:

- SCPI. must be at the beginning. Notice that the IEEE common commands start with SCPI.IEEE4882. and "\*" is omitted.
- Replace colons (:) used as the hierarchical separator symbol with dots (.).
- The number written in the object message is specified with ().
- You cannot omit the command message in the syntax.

SCPI command	COM object
OUTPUT 717;".SENS:SP:AVER:CONT 16"	→ SCPI.SENSE.SP.AVERage.COUNt = 16
OUTPUT 717;".SENS:SP:AVER:STAT?" ENTER 717;AS	→ A = SCPI.SENSE.SP.AVERage.STATe
OUTPUT 717;"*CLS"	→ SCPI.IEEE4882.CLS

## Notational Rules of COM Objects

This section describes the rules for the description of the COM objects in this chapter.

### Syntax

Part with heading “Syntax” describes the syntax to send a COM object from the E5052A VBA to the E5052A. The syntax consists of the object part and the set/read part, with an equal “=” inserted between them. Variables are indicated by italicized letters. Variables with () are indices. For indices with () having their preset values, you can omit “(variable),” and, if omitted, the preset values are automatically set.

There are the following 3 types of syntax for coding using objects.

"Object (property) = *variable*": to set the stat of the E5052A.

*variable*=object (property): to read the stat of the E5052A.

"Object (method)": to make the E5052A perform some processing.

### Description

Part with heading “Description” describes how to use the COM object or the operation when executed. COM objects used only to read the state of the E5052A are indicated with “Read only” and ones used only to set the state of the E5052A “No read.”

## Variable

Part with heading “Variable” describes necessary variables when using the object. It gives the description, data type, allowable range, preset value, unit, resolution, and notes for *variable* (*italic*) shown in the syntax.

Variables declared as the string data type (String) are case insensitive. For variables of the string type that indicate arguments (written as *Param* in the syntax), you can omit lower-case letters.

The data types of the E5052A COM objects include 5 types as shown in Table 7-1. Before using variables, declare the data type of each variable. If you do not declare the data type of a variable, it is automatically dealt as the variant type.

**Table 7-1 Data type**

Data type	Name	Consumed memory	Range
Long	Long integer type	4 bytes	-2,147,483,648 to 2,147,483,647
Double	Double precision floating point type	8 bytes	For a negative value: -1.79769313486232E+308 to -4.94065645841247E-324  For a positive value: -1.79769313486232E+308 to -4.94065645841247E-324
Boolean	Boolean type	2 bytes	-1 (True) or 0 (False)
String	Character string type *1	1 byte/alphanumeric character	Up to approximately 2 billion characters
Variant	Variant type	16 bytes	No limitation

\*1. For a fixed length string, declare the number of characters.

## Examples

Part with heading “Examples” describes a simple example of how to use the object for coding with E5052A VBA.

## Equivalent Key

Part with heading “Equivalent key” shows the operational procedure of the front panel keys that has the same effect as this object.

**[Key]** Indicates that you press the key named Key.

**[Key] -> Item** Indicates a series of key operation in which you press the **[Key]** key, move the focus to the button called Item on the displayed menu using the **[←↓]** key and so on, and then press the **[Enter]** key.

---

## Application Objects

The Application objects are at the top of the hierarchy of the E5052A COM object model. They consist of 3 objects dedicated to the E5052A COM interface and SCPI objects corresponding to SCPI commands. This section describes the objects dedicated to the E5052A COM interface.

### NAME

Object type	Property
Syntax	<i>App</i> = NAME
Description	Reads out the application name of VBA. "E5052A" is always read out. (Read only)
Variable	

	<i>App</i>
Description	Application name
Data type	Character string type (String)

Equivalent key No equivalent key is available on the front panel.

### Parse

Object type	Method
Syntax	<i>Parse(Scpi)</i> <i>Return</i> = <i>Parse(Scpi?)</i>
Description	Executes an SCPI command of the E5052A. For information on the SCPI commands, see Chapter "SCPI Command Reference" in the <i>E5052A Programmer's Guide</i> .  The <b>Parse</b> object is a little slower in the execution speed than the COM object which has the same function as the SCPI command because it must parse the message string of the SCPI command.
Variable	

	<i>Scpi</i>
Description	SCPI command
Data type	Character string type (String)

	<i>Return</i>
Description	Response (query) of the SCPI command



	<b><i>Return</i></b>
Data type	Character string type (String)

Equivalent key No equivalent key is available on the front panel.

## **VBAVersion**

Object type Property

Syntax *Vers* = VBAVersion

Description Reads out the version information of VBA installed in the E5052A. (Read only)

Variable

	<b><i>Vers</i></b>
Description	VBA version information
Data type	Character string type (String)

Equivalent key From the **Help** menu of the Visual Basic editor, click **About Microsoft Visual Basic....**

---

## SCPI Objects

SCPI objects are a collection of the COM interface having one-on-one correspondence with the SCPI commands. This section describes the SCPI objects provided for the E5052A.

### SCPI.ABORT

Syntax	SCPI.ABORT
Description	Abort measurement (No Read)
Equivalent key	No equivalent key is available on the front panel.

### SCPI.CALCulate.FP(1-1).ALLTrace.ACTive

Syntax	SCPI.CALCulate.FP(1-1).ALLTrace.ACTive = <long> <long> = SCPI.CALCulate.FP(1-1).ALLTrace.ACTive
Description	Selects active trace
Variable	

	<b>&lt;Long&gt;</b>
Range	1 to 4
Preset value	1
Unit	-
Resolution	-

Equivalent key	No equivalent key is available on the front panel.
----------------	--

### SCPI.CALCulate.FP(1-1).ALLTrace.BDMarker.X.COUPle.STATE

Syntax	SCPI.CALCulate.FP(1-1).ALLTrace.BDMarker.X.COUPle.STATE = <boolean> <boolean> = SCPI.CALCulate.FP(1-1).ALLTrace.BDMarker.X.COUPle.STATE
Description	Turns on/off bandmarker X coupling function
Variable	

	<b>Param</b>
True or -1	Set bandmarker X coupling function mode to 'ON'

	Param
False or 0(Preset value)	Set bandmarker X coupling function mode to 'OFF'

Equivalent key  
 FP Menu -> Marker Function -> Couple  
 FP Menu -> Marker Search -> Couple

**SCPI.CALCulate.FP(1-1).ALLTrace.LIMit.FAIL**

<boolean> = SCPI.CALCulate.FP(1-1).ALLTrace.LIMit.FAIL

Description Reads out the limit test result (Query Only)

Variable

	Param
True or -1	The limit test result is fail
False or 0(Preset value)	The limit test result is pass

When the limit test is set to OFF, false or 0 is always read out.

Equivalent key No equivalent key is available on the front panel.

**SCPI.CALCulate.FP(1-1).ALLTrace.MARKer.COUPle.STATe**

Syntax SCPI.CALCulate.FP(1-1).ALLTrace.MARKer.COUPle.STATe = <boolean>  
 <boolean> = SCPI.CALCulate.FP(1-1).ALLTrace.MARKer.COUPle.STATe

Description Turns on/of marker coupling function

Variable

	Param
True or -1	Set marker coupling function mode to 'ON'
False or 0(Preset value)	Set marker coupling function mode to 'OFF'

Equivalent key FP Menu -> Marker -> Couple

**SCPI.CALCulate.FP(1-1).ALLTrace.MARKer.DISCrete.STATe**

**Syntax** SCPI.CALCulate.FP(1-1).ALLTrace.MARKer.DISCrete.STATe = <boolean>  
 <boolean> = SCPI.CALCulate.FP(1-1).ALLTrace.MARKer.DISCrete.STATe

**Description** Enables/disables marker discrete function

**Variable**

	<b>Param</b>
True or -1	Enable marker discrete function
False or 0(Preset value)	Disable marker discrete function

**Equivalent key** FP Menu -> Marker -> More Functions -> Discrete

**SCPI.CALCulate.FP(1-1).ALLTrace.MARKer.REFerence.NUMBer**

**Syntax** SCPI.CALCulate.FP(1-1).ALLTrace.MARKer.REFerence.NUMBer = <long>  
 <long> = SCPI.CALCulate.FP(1-1).ALLTrace.MARKer.REFerence.NUMBer

**Description** Sets/reads marker reference number

**Variable**

	<b>&lt;Long&gt;</b>
Range	1 to 6
Preset value	1
Unit	-
Resolution	-

**Equivalent key** FP Menu -> Marker -> More Functions -> Ref Marker

**SCPI.CALCulate.FP(1-1).ALLTrace.MARKer.REFerence.STATe**

**Syntax** SCPI.CALCulate.FP(1-1).ALLTrace.MARKer.REFerence.STATe = <boolean>  
 <boolean> = SCPI.CALCulate.FP(1-1).ALLTrace.MARKer.REFerence.STATe

**Description** Turns on/off delta marker mode

Variable

	Param
True or -1	Set delta marker mode to 'ON'
False or 0(Preset value)	Set delta marker mode to 'OFF'

Equivalent key FP Menu -> Marker -> More Functions -> Ref Marker Mode

### **SCPI.CALCulate.FP(1-1).DATA.RDATA**

Syntax SCPI.CALCulate.FP(1-1).DATA.RDATA = <variant>  
 <variant> = SCPI.CALCulate.FP(1-1).DATA.RDATA

Description Sets/reads the measurement raw data

Variable

	<Variant>
Range	1...3003
Preset value	-
Unit	-
Resolution	-

Equivalent key No equivalent key is available on the front panel.

### **SCPI.CALCulate.FP(1-1).DATA.TDATA**

Syntax <variant> = SCPI.CALCulate.FP(1-1).DATA.TDATA

Description Sets/Reads tester mode data

Variable

	<Variant>
Range	1...3
Preset value	-
Unit	-
Resolution	-

Equivalent key No equivalent key is available on the front panel.

## SCPI.CALCulate.FP(1-1).DATA.XDATA

Syntax	<variant> = SCPI.CALCulate.FP(1-1).DATA.XDATA
Description	Reads X-axis data (Read Only)
Equivalent key	No equivalent key is available on the front panel.

## SCPI.CALCulate.FP(1-1).TRACe(1-4).ALLMarker.ACTive

Syntax	SCPI.CALCulate.FP(1-1).TRACe(1-4).ALLMarker.ACTive = <long> <long> = SCPI.CALCulate.FP(1-1).TRACe(1-4).ALLMarker.ACTive
Description	Selects active marker
Variable	

	<Long>
Range	1 to 6
Preset value	1
Unit	-
Resolution	-

Equivalent key	No equivalent key is available on the front panel.
----------------	--

## SCPI.CALCulate.FP(1-1).TRACe(1-4).ALLMarker.SEARCh.DOMain.X

Syntax	SCPI.CALCulate.FP(1-1).TRACe(1-4).ALLMarker.SEARCh.DOMain.X = <string> <string> = SCPI.CALCulate.FP(1-1).TRACe(1-4).ALLMarker.SEARCh.DOMain.X
Description	Sets/reads marker search range (X-axis)
Variable	

	Param
FRANge(Preset value)	Set marker search range (X-axis) to 'FRANge'
BDMarker	Set marker search range (X-axis) to 'BDMarker'

Equivalent key	FP Menu -> Marker Search -> Search Range (X)
----------------	--

**SCPI.CALCulate.FP(1-1).TRACe(1-4).ALLMarker.SEARch.DOMain.Y**

Syntax SCPI.CALCulate.FP(1-1).TRACe(1-4).ALLMarker.SEARch.DOMain.Y = <string>  
<string> = SCPI.CALCulate.FP(1-1).TRACe(1-4).ALLMarker.SEARch.DOMain.Y

Description Sets/reads marker search range (Y-axis)

Variable

	Param
FRANge(Preset value)	Set marker search range (Y-axis) to 'FRANge'
BDMarker	Set marker search range (Y-axis) to 'BDMarker'

Equivalent key FP Menu -> Marker Search -> Search Range (Y)

**SCPI.CALCulate.FP(1-1).TRACe(1-4).ALLMarker.SEARch.PEAK**

Syntax SCPI.CALCulate.FP(1-1).TRACe(1-4).ALLMarker.SEARch.PEAK

Description Execute marker search all (No Read)

Equivalent key FP Menu -> Marker Search -> Peak -> Search Peak All

**SCPI.CALCulate.FP(1-1).TRACe(1-4).BDMarker.X.CENTer**

Syntax SCPI.CALCulate.FP(1-1).TRACe(1-4).BDMarker.X.CENTer = <double>  
<double> = SCPI.CALCulate.FP(1-1).TRACe(1-4).BDMarker.X.CENTer

Description Sets/reads the center value of bandmarker X

Variable

	<Double>
Range	-1T to 1T
Preset value	0
Unit	-
Resolution	-

Equivalent key FP Menu -> Marker Function -> Band Marker X -> Center

FP Menu -&gt; Marker Search -&gt; Band Marker X -&gt; Center

**SCPI.CALCulate.FP(1-1).TRACe(1-4).BDMarker.X.SPAN**

Syntax SCPI.CALCulate.FP(1-1).TRACe(1-4).BDMarker.X.SPAN = <double>  
<double> = SCPI.CALCulate.FP(1-1).TRACe(1-4).BDMarker.X.SPAN

Description Sets/reads the span value of bandmarker X

Variable

	<Double>
Range	0 to 2T
Preset value	2T
Unit	-
Resolution	-

Equivalent key FP Menu -> Marker Function -> Band Marker X -> Span

FP Menu -> Marker Search -> Band Marker X -> Span

**SCPI.CALCulate.FP(1-1).TRACe(1-4).BDMarker.X.START**

Syntax SCPI.CALCulate.FP(1-1).TRACe(1-4).BDMarker.X.START = <double>  
<double> = SCPI.CALCulate.FP(1-1).TRACe(1-4).BDMarker.X.START

Description Sets/reads the start value of bandmarker X

Variable

	<Double>
Range	-1T to 1T
Preset value	-1T
Unit	-
Resolution	-

Equivalent key FP Menu -> Marker Function -> Band Marker X -> Start

FP Menu -> Marker Search -> Band Marker X -> Start

**SCPI.CALCulate.FP(1-1).TRACe(1-4).BDMarker.X.STATe**

Syntax SCPI.CALCulate.FP(1-1).TRACe(1-4).BDMarker.X.STATe = <boolean>  
<boolean> = SCPI.CALCulate.FP(1-1).TRACe(1-4).BDMarker.X.STATe



Description Turns on/off bandmarker X

Variable

	Param
True or -1	Set bandmarker X to 'ON'
False or 0(Preset value)	Set bandmarker X to 'OFF'

Equivalent key FP Menu -> Marker Function -> Band Marker X -> Band Marker X  
 FP Menu -> Marker Search -> Band Marker X -> Band Marker X

**SCPI.CALCulate.FP(1-1).TRACe(1-4).BDMarker.X.STOP**

Syntax SCPI.CALCulate.FP(1-1).TRACe(1-4).BDMarker.X.STOP = <double>  
 <double> = SCPI.CALCulate.FP(1-1).TRACe(1-4).BDMarker.X.STOP

Description Sets/reads the stop value of bandmarker X

Variable

	<Double>
Range	-1T to 1T
Preset value	1T
Unit	-
Resolution	-

Equivalent key FP Menu -> Marker Function -> Band Marker X -> Stop  
 FP Menu -> Marker Search -> Band Marker X -> Stop

**SCPI.CALCulate.FP(1-1).TRACe(1-4).BDMarker.Y.CENTe  
 r**

Syntax SCPI.CALCulate.FP(1-1).TRACe(1-4).BDMarker.Y.CENTer = <double>  
 <double> = SCPI.CALCulate.FP(1-1).TRACe(1-4).BDMarker.Y.CENTer

Description Sets/reads the center value of bandmarker Y

Variable

	<Double>
Range	-1T to 1T

	<b>&lt;Double&gt;</b>
Preset value	0
Unit	-
Resolution	-

Equivalent key FP Menu -> Marker Function -> Band Marker Y -> Center

FP Menu -> Marker Search -> Band Marker Y -> Center

### **SCPI.CALCulate.FP(1-1).TRACe(1-4).BDMarker.Y.SPAN**

Syntax SCPI.CALCulate.FP(1-1).TRACe(1-4).BDMarker.Y.SPAN = <double>

<double> = SCPI.CALCulate.FP(1-1).TRACe(1-4).BDMarker.Y.SPAN

Description Sets/reads the span value of bandmarker Y

Variable

	<b>&lt;Double&gt;</b>
Range	0 to 2T
Preset value	2T
Unit	-
Resolution	-

Equivalent key FP Menu -> Marker Function -> Band Marker Y -> Span

FP Menu -> Marker Search -> Band Marker Y -> Span

### **SCPI.CALCulate.FP(1-1).TRACe(1-4).BDMarker.Y.START**

Syntax SCPI.CALCulate.FP(1-1).TRACe(1-4).BDMarker.Y.START = <double>

<double> = SCPI.CALCulate.FP(1-1).TRACe(1-4).BDMarker.Y.START

Description Sets/reads the start value of bandmarker Y

Variable

	<b>&lt;Double&gt;</b>
Range	-IT to IT
Preset value	-IT
Unit	-
Resolution	-

Equivalent key FP Menu -> Marker Function -> Band Marker Y -> Start  
 FP Menu -> Marker Search -> Band Marker Y -> Start

### SCPI.CALCulate.FP(1-1).TRACe(1-4).BDMarker.Y.STATe

Syntax SCPI.CALCulate.FP(1-1).TRACe(1-4).BDMarker.Y.STATe = <boolean>  
 <boolean> = SCPI.CALCulate.FP(1-1).TRACe(1-4).BDMarker.Y.STATe

Description Turns on/off bandmarker Y

Variable

	Param
True or -1	Set bandmarker Y to 'ON'
False or 0(Preset value)	Set bandmarker Y to 'OFF'

Equivalent key FP Menu -> Marker Function -> Band Marker Y -> Band Marker Y  
 FP Menu -> Marker Search -> Band Marker Y -> Band Marker Y

### SCPI.CALCulate.FP(1-1).TRACe(1-4).BDMarker.Y.STOP

Syntax SCPI.CALCulate.FP(1-1).TRACe(1-4).BDMarker.Y.STOP = <double>  
 <double> = SCPI.CALCulate.FP(1-1).TRACe(1-4).BDMarker.Y.STOP

Description Sets/reads the stop value of bandmarker Y

Variable

	<Double>
Range	-1T to 1T
Preset value	1T
Unit	-
Resolution	-

Equivalent key FP Menu -> Marker Function -> Band Marker Y -> Stop  
 FP Menu -> Marker Search -> Band Marker Y -> Stop

### SCPI.CALCulate.FP(1-1).TRACe(1-4).DATA.COPY

Syntax SCPI.CALCulate.FP(1-1).TRACe(1-4).DATA.COPY

Description Copies trace data to the user trace (No Query)

Variable

	<b>&lt;Long&gt;</b>
Range	1 to 8
Preset value	-
Unit	-
Resolution	-

Equivalent key

FP Menu -> Trace View-> Copy to USER -> Copy to USER1  
 FP Menu -> Trace View-> Copy to USER -> Copy to USER2  
 FP Menu -> Trace View-> Copy to USER -> Copy to USER3  
 FP Menu -> Trace View-> Copy to USER -> Copy to USER4  
 FP Menu -> Trace View-> Copy to USER -> Copy to USER5  
 FP Menu -> Trace View-> Copy to USER -> Copy to USER6  
 FP Menu -> Trace View-> Copy to USER -> Copy to USER7  
 FP Menu -> Trace View-> Copy to USER -> Copy to USER8

**SCPI.CALCulate.FP(1-1).TRACe(1-4).DATA.FDATa**

Syntax

SCPI.CALCulate.FP(1-1).TRACe(1-4).DATA.FDATa = <variant>  
 <variant> = SCPI.CALCulate.FP(1-1).TRACe(1-4).DATA.FDATa

Description

Set/Get formatted trace data

Variable

	<b>&lt;Variant&gt;</b>
Range	1...1001
Preset value	-
Unit	-
Resolution	-

Equivalent key

No equivalent key is available on the front panel.

**SCPI.CALCulate.FP(1-1).TRACe(1-4).DATA.FMEMory**

Syntax

SCPI.CALCulate.FP(1-1).TRACe(1-4).DATA.FMEMory = <variant>  
 <variant> = SCPI.CALCulate.FP(1-1).TRACe(1-4).DATA.FMEMory

Description

Sets/reads formatted memory data

Variable

	<Variant>
Range	1...1001
Preset value	-
Unit	-
Resolution	-

Equivalent key No equivalent key is available on the front panel.

**SCPI.CALCulate.FP(1-1).TRACe(1-4).DATA.UDATa**

Syntax SCPI.CALCulate.FP(1-1).TRACe(1-4).DATA.UDATa = <variant>  
 <variant> = SCPI.CALCulate.FP(1-1).TRACe(1-4).DATA.UDATa

Description Sets/reads unformatted trace data

Variable

	<Variant>
Range	1...1001
Preset value	-
Unit	-
Resolution	-

Equivalent key No equivalent key is available on the front panel.

**SCPI.CALCulate.FP(1-1).TRACe(1-4).DATA.UMEMory**

Syntax SCPI.CALCulate.FP(1-1).TRACe(1-4).DATA.UMEMory = <variant>  
 <variant> = SCPI.CALCulate.FP(1-1).TRACe(1-4).DATA.UMEMory

Description Sets/reads unformatted memory data

Variable

	<Variant>
Range	1...1001
Preset value	-
Unit	-

	<b>&lt;Variant&gt;</b>
Resolution	-

Equivalent key No equivalent key is available on the front panel.

## **SCPI.CALCulate.FP(1-1).TRACe(1-4).FORMat.FREQuency**

Syntax SCPI.CALCulate.FP(1-1).TRACe(1-4).FORMat.FREQuency = <string>  
 <string> = SCPI.CALCulate.FP(1-1).TRACe(1-4).FORMat.FREQuency

Description Selects FP-frequency format

Variable

	<b>Param</b>
HZ(Preset value)	Set FP-frequency format to 'Hz'
HZV	Set FP-frequency format to ' Hz/V' (Hz/V:Tuning sensitivity)
DHZ	Set FP-frequency format to 'ΔHz'
PCT	Set FP-frequency format to '%'
PPM	Set FP-frequency format to 'ppm'

This command is available when trace1 or trace 4.

Equivalent key FP Menu -> Format -> Frequency Format

## **SCPI.CALCulate.FP(1-1).TRACe(1-4).FUNCTion.DOMain.X**

Syntax SCPI.CALCulate.FP(1-1).TRACe(1-4).FUNCTion.DOMain.X = <string>  
 <string> = SCPI.CALCulate.FP(1-1).TRACe(1-4).FUNCTion.DOMain.X

Description Sets/reads analysis/search range (X-axis)

Variable

	<b>Param</b>
FRANge	Set analysis/search range (X-axis) to 'FRANge'
BDMarker(Preset value)	Set analysis/search range (X-axis) to 'BDMarker'

Equivalent key FP Menu -> Marker Function -> Analysis Range (X)

## **SCPI.CALCulate.FP(1-1).TRACe(1-4).FUNCTion.DOMain.Y**

- Syntax** SCPI.CALCulate.FP(1-1).TRACe(1-4).FUNCTion.DOMain.Y = <string>  
 <string> = SCPI.CALCulate.FP(1-1).TRACe(1-4).FUNCTion.DOMain.Y
- Description** Sets/reads analysis/search range (Y-axis)
- Variable**

	<b>Param</b>
FRANge	Set analysis/search range (Y-axis) to 'FRANge'
BDMarker(Preset value)	Set analysis/search range (Y-axis) to 'BDMarker'

- Equivalent key** FP Menu -> Marker Function -> Analysis Range (Y)

## **SCPI.CALCulate.FP(1-1).TRACe(1-4).FUNCTion.STATistic s.DATA**

- Syntax** SCPI.CALCulate.FP(1-1).TRACe(1-4).FUNCTion.STATistics.DATA\_Q mean, s\_dev, p\_p
- Description** Reads the results of statistical analysis for the data trace (Read Only)
- Examples**
- ```
Dim meas As Double
Dim s_dev As Double
Dim p_p As Double

SCPI.CALCulate.FP.TRACe.FUNCTion.STATistics.DATA_Q mean, s_dev, p_p
```
- Equivalent key** No equivalent key is available on the front panel.

## **SCPI.CALCulate.FP(1-1).TRACe(1-4).FUNCTion.STATistic s.MEMory\_Q**

- Syntax** SCPI.CALCulate.FP(1-1).TRACe(1-4).FUNCTion.STATistics.MEMory\_Q mean, std\_dev, peak\_to\_peak
- Description** Reads the results of statistical analysis for the memory trace (Read Only)
- Examples**
- ```
Dim meas As Double
Dim s_dev As Double
Dim p_p As Double

SCPI.CALCulate.FP.TRACe.FUNCTion.STATistics.MEMory_Q mean, s_dev, p_p
```
- Equivalent key** No equivalent key is available on the front panel.

**SCPI.CALCulate.FP(1-1).TRACe(1-4).FUNCtion.TYPE**

Syntax SCPI.CALCulate.FP(1-1).TRACe(1-4).FUNCtion.TYPE = <string>  
<string> = SCPI.CALCulate.FP(1-1).TRACe(1-4).FUNCtion.TYPE

Description Sets/reads analysis type

Variable

	Param
OFF(Preset value)	Set analysis type to 'OFF'
STATistics	Set analysis type to 'STATistics'

Equivalent key FP Menu -> Marker Function -> Analysis Type

**SCPI.CALCulate.FP(1-1).TRACe(1-4).HOLD**

Syntax SCPI.CALCulate.FP(1-1).TRACe(1-4).HOLD = <string>  
<string> = SCPI.CALCulate.FP(1-1).TRACe(1-4).HOLD

Description Selects data hold type

Variable

	Param
OFF(Preset value)	Set data hold type to 'OFF'
MAXimum	Set data hold type to 'MAXimum'
MINimum	Set data hold type to 'MINimum'

Equivalent key FP Menu -> Trace View -> Data Hold

**SCPI.CALCulate.FP(1-1).TRACe(1-4).LIMit.FAIL**

<boolean> = SCPI.CALCulate.FP(1-1).TRACe(1-4).LIMit.FAIL

Description Reads out the limit test result (Query Only)

Variable

	Param
True or -1	The limit test result is fail
False or 0(Preset value)	The limit test result is pass



When the limit test is set to OFF, false or 0 is always read out.

Equivalent key No equivalent key is available on the front panel.

### **SCPI.CALCulate.FP(1-1).TRACe(1-4).LIMit.LOWer.LDATa**

Syntax SCPI.CALCulate.FP(1-1).TRACe(1-4).LIMit.LOWer.LDATa = <variant>  
<variant> = SCPI.CALCulate.FP(1-1).TRACe(1-4).LIMit.LOWer.LDATa

Description Sets/reads the lower limit values of all measurement points

Variable

	<Variant>
Range	1...1001
Preset value	-
Unit	-
Resolution	-

Equivalent key No equivalent key is available on the front panel.

### **SCPI.CALCulate.FP(1-1).TRACe(1-4).LIMit.LOWer.SEGMent.CLEAr**

Syntax SCPI.CALCulate.FP(1-1).TRACe(1-4).LIMit.LOWer.SEGMent.CLEAr

Description Clears the lower limit line (No Query)

Equivalent key FP Menu -> Display -> Limit Test -> Delete Lower Limit Line

### **SCPI.CALCulate.FP(1-1).TRACe(1-4).LIMit.LOWer.SEGMent.COUNT**

Syntax SCPI.CALCulate.FP(1-1).TRACe(1-4).LIMit.LOWer.SEGMent.COUNT = <long>  
<long> = SCPI.CALCulate.FP(1-1).TRACe(1-4).LIMit.LOWer.SEGMent.COUNT

Description Sets/reads the number of segments in the lower limit line

Variable

	<Long>
Range	1 to 100

	<b>&lt;Long&gt;</b>
Preset value	1
Unit	-
Resolution	-

Equivalent key No equivalent key is available on the front panel.

### **SCPI.CALCulate.FP(1-1).TRACe(1-4).LIMit.LOWer.SEGMent.DATA**

Syntax SCPI.CALCulate.FP(1-1).TRACe(1-4).LIMit.LOWer.SEGMent.DATA = <variant>  
<variant> = SCPI.CALCulate.FP(1-1).TRACe(1-4).LIMit.LOWer.SEGMent.DATA

Description Sets/reads segment data of the lower limit line

Variable

	<b>&lt;Variant&gt;</b>
Range	1...400
Preset value	-
Unit	-
Resolution	-

Equivalent key No equivalent key is available on the front panel.

### **SCPI.CALCulate.FP(1-1).TRACe(1-4).LIMit.REPort.DATA**

<variant> = SCPI.CALCulate.FP(1-1).TRACe(1-4).LIMit.REPort.DATA

Description Reads the limit test results of all measurement points in selected traces (Query Only)

Equivalent key No equivalent key is available on the front panel.

### **SCPI.CALCulate.FP(1-1).TRACe(1-4).LIMit.STATe**

Syntax SCPI.CALCulate.FP(1-1).TRACe(1-4).LIMit.STATe = <boolean>  
<boolean> = SCPI.CALCulate.FP(1-1).TRACe(1-4).LIMit.STATe

Description Turns on/off the limit test function

Variable

	Param
True or -1	Turn on the limit test function mode
False or 0(Preset value)	Turn off the limit test function mode

Equivalent key FP Menu -> Display -> Limit Test -> Limit Test

**SCPI.CALCulate.FP(1-1).TRACe(1-4).LIMit.UPPer.LDATa**

Syntax SCPI.CALCulate.FP(1-1).TRACe(1-4).LIMit.UPPer.LDATa = <variant>  
 <variant> = SCPI.CALCulate.FP(1-1).TRACe(1-4).LIMit.UPPer.LDATa

Description Sets/reads the upper limit values of all measurement points

Variable

	<Variant>
Range	1...1001
Preset value	-
Unit	-
Resolution	-

Equivalent key No equivalent key is available on the front panel.

**SCPI.CALCulate.FP(1-1).TRACe(1-4).LIMit.UPPer.SEGMent.CLEAr**

Syntax SCPI.CALCulate.FP(1-1).TRACe(1-4).LIMit.UPPer.SEGMent.CLEAr

Description Clears the upper limit line (No Query)

Equivalent key FP Menu -> Display -> Limit Test -> Delete Upper Limit Line

**SCPI.CALCulate.FP(1-1).TRACe(1-4).LIMit.UPPer.SEGMent.COUNT**

Syntax SCPI.CALCulate.FP(1-1).TRACe(1-4).LIMit.UPPer.SEGMent.COUNT = <long>  
 <long> = SCPI.CALCulate.FP(1-1).TRACe(1-4).LIMit.UPPer.SEGMent.COUNT

Description Sets/reads the number of segments in the upper limit line

Variable

	<Long>
Range	1 to 100
Preset value	1
Unit	-
Resolution	-

Equivalent key No equivalent key is available on the front panel.

**SCPI.CALCulate.FP(1-1).TRACe(1-4).LIMit.UPPer.SEGMent.DATA**

Syntax SCPI.CALCulate.FP(1-1).TRACe(1-4).LIMit.UPPer.SEGMent.DATA = <variant>

<variant> = SCPI.CALCulate.FP(1-1).TRACe(1-4).LIMit.UPPer.SEGMent.DATA

Description Sets/reads segment data of the upper limit line

Variable

	<Variant>
Range	1...400
Preset value	-
Unit	-
Resolution	-

Equivalent key No equivalent key is available on the front panel.

**SCPI.CALCulate.FP(1-1).TRACe(1-4).MARKer(1-6).SEARch.EXECute.LPEak**

Syntax SCPI.CALCulate.FP(1-1).TRACe(1-4).MARKer(1-6).SEARch.EXECute.LPEak

Description Execute marker peak search left (No Read)

Equivalent key FP Menu -> Marker Search -> Peak -> Search Left

**SCPI.CALCulate.FP(1-1).TRACe(1-4).MARKer(1-6).SEARch.EXECute.LTARget**

Syntax SCPI.CALCulate.FP(1-1).TRACe(1-4).MARKer(1-6).SEARch.EXECute.LTARget

Description Execute marker target search left (No Read)

**SCPI.CALCulate.FP(1-1).TRACe(1-4).MARKer(1-6).SEARch.EXECute.MAXimum**

Equivalent key FP Menu -> Marker Search -> Target -> Search Left

**SCPI.CALCulate.FP(1-1).TRACe(1-4).MARKer(1-6).SEARch.EXECute.MAXimum**

Syntax SCPI.CALCulate.FP(1-1).TRACe(1-4).MARKer(1-6).SEARch.EXECute.MAXimum

Description Execute marker search maximum (No Read)

Equivalent key FP Menu -> Marker Search -> Search Max

**SCPI.CALCulate.FP(1-1).TRACe(1-4).MARKer(1-6).SEARch.EXECute.MINimum**

Syntax SCPI.CALCulate.FP(1-1).TRACe(1-4).MARKer(1-6).SEARch.EXECute.MINimum

Description Execute marker search minimum (No Read)

Equivalent key FP Menu -> Marker Search -> Search Min

**SCPI.CALCulate.FP(1-1).TRACe(1-4).MARKer(1-6).SEARch.EXECute.PEAK**

Syntax SCPI.CALCulate.FP(1-1).TRACe(1-4).MARKer(1-6).SEARch.EXECute.PEAK

Description Execute marker peak search (No Read)

Equivalent key FP Menu -> Marker Search -> Peak -> Search Peak

**SCPI.CALCulate.FP(1-1).TRACe(1-4).MARKer(1-6).SEARch.EXECute.RPEak**

Syntax SCPI.CALCulate.FP(1-1).TRACe(1-4).MARKer(1-6).SEARch.EXECute.RPEak

Description Execute marker peak search right (No Read)

Equivalent key FP Menu -> Marker Search -> Peak -> Search Right

**SCPI.CALCulate.FP(1-1).TRACe(1-4).MARKer(1-6).SEARch.EXECute.RTARget**

Syntax SCPI.CALCulate.FP(1-1).TRACe(1-4).MARKer(1-6).SEARch.EXECute.RTARget

Description Execute marker target search right (No Read)

Equivalent key FP Menu -> Marker Search -> Target -> Search Right

**SCPI.CALCulate.FP(1-1).TRACe(1-4).MARKer(1-6).SEARch.EXECute.TARGet**

Syntax SCPI.CALCulate.FP(1-1).TRACe(1-4).MARKer(1-6).SEARch.EXECute.TARGet

Description Execute marker target search (No Read)

Equivalent key FP Menu -> Marker Search -> Target -> Search Target

**SCPI.CALCulate.FP(1-1).TRACe(1-4).MARKer(1-6).SEARch.PEAK.EXCursion**

Syntax SCPI.CALCulate.FP(1-1).TRACe(1-4).MARKer(1-6).SEARch.PEAK.EXCursion =  
<double>

<double> =

SCPI.CALCulate.FP(1-1).TRACe(1-4).MARKer(1-6).SEARch.PEAK.EXCursion

Description Sets/reads the peak excursion value

Variable

	<b>&lt;Double&gt;</b>
Range	0 to 10G
Preset value	0
Unit	-
Resolution	-

Equivalent key FP Menu -> Marker Search -> Peak -> Peak Excursion

**SCPI.CALCulate.FP(1-1).TRACe(1-4).MARKer(1-6).SEARch.PEAK.POLarity**

Syntax SCPI.CALCulate.FP(1-1).TRACe(1-4).MARKer(1-6).SEARch.PEAK.POLarity =  
<string>

<string> =

SCPI.CALCulate.FP(1-1).TRACe(1-4).MARKer(1-6).SEARch.PEAK.POLarity

Description Sets/reads the marker peak-search polarity

Variable

	<b>Param</b>
POSitive(Preset value)	Set the marker peak-search polarity to 'POSitive'

	Param
NEGative	Set the marker peak-search polarity to 'NEGative'
BOTH	Set the marker peak-search polarity to 'BOTH'

Equivalent key FP Menu -> Marker Search -> Peak -> Peak Polarity

### SCPI.CALCulate.FP(1-1).TRACe(1-4).MARKer(1-6).SEARch.TARGet.TRANSition

Syntax SCPI.CALCulate.FP(1-1).TRACe(1-4).MARKer(1-6).SEARch.TARGet.TRANSition = <string>  
<string> = SCPI.CALCulate.FP(1-1).TRACe(1-4).MARKer(1-6).SEARch.TARGet.TRANSition

Description Sets/reads the target transition definition

Variable

	Param
POSitive	Set the target transition definition to 'POSitive'
NEGative	Set the target transition definition to 'NEGative'
BOTH(Preset value)	Set the target transition definition to 'BOTH'

Equivalent key FP Menu -> Marker Search -> Target -> Target Transition

### SCPI.CALCulate.FP(1-1).TRACe(1-4).MARKer(1-6).SEARch.TARGet.Y

Syntax SCPI.CALCulate.FP(1-1).TRACe(1-4).MARKer(1-6).SEARch.TARGet.Y = <double>  
<double> = SCPI.CALCulate.FP(1-1).TRACe(1-4).MARKer(1-6).SEARch.TARGet.Y

Description Sets/reads the marker target value

Variable

	<Double>
Range	-10G to 10G
Preset value	0
Unit	-
Resolution	-

Equivalent key FP Menu -> Marker Search -> Target -> Target Value

### **SCPI.CALCulate.FP(1-1).TRACe(1-4).MARKer(1-6).SEARCh.TRACking.TYPE**

Syntax SCPI.CALCulate.FP(1-1).TRACe(1-4).MARKer(1-6).SEARCh.TRACking.TYPE = <string>

<string> =

SCPI.CALCulate.FP(1-1).TRACe(1-4).MARKer(1-6).SEARCh.TRACking.TYPE

Description Sets/reads the marker tracking type

Variable

	<b>Param</b>
OFF(Preset value)	Set the marker tracking type to 'OFF'
MAXimum	Set the marker tracking type to 'MAXimum'
MINimum	Set the marker tracking type to 'MINimum'
PEAK	Set the marker tracking type to 'PEAK'
TARGet	Set the marker tracking type to 'TARGet'

Equivalent key FP Menu -> Marker Search -> Tracking

### **SCPI.CALCulate.FP(1-1).TRACe(1-4).MARKer(1-6).STATe**

Syntax SCPI.CALCulate.FP(1-1).TRACe(1-4).MARKer(1-6).STATe = <boolean>

<boolean> = SCPI.CALCulate.FP(1-1).TRACe(1-4).MARKer(1-6).STATe

Description Turns on/off a marker

Variable

	<b>Param</b>
True or -1	Set a marker to 'ON'
False or 0(Preset value)	Set a marker to 'OFF'

Equivalent key FP Menu -> Marker -> Clear Marker Menu -> Marker 1

### **SCPI.CALCulate.FP(1-1).TRACe(1-4).MARKer(1-6).X**

Syntax SCPI.CALCulate.FP(1-1).TRACe(1-4).MARKer(1-6).X = <double>

<double> = SCPI.CALCulate.FP(1-1).TRACe(1-4).MARKer(1-6).X



Description Sets/reads the marker X value

Variable

	<Double>
Range	-
Preset value	0
Unit	-
Resolution	-

Equivalent key No equivalent key is available on the front panel.

**SCPI.CALCulate.FP(1-1).TRACe(1-4).MARKer(1-6).Y**

Syntax <double> = SCPI.CALCulate.FP(1-1).TRACe(1-4).MARKer(1-6).Y

Description Reads the marker Y value (Read Only)

Equivalent key No equivalent key is available on the front panel.

**SCPI.CALCulate.FP(1-1).TRACe(1-4).MATH.FUNcTion**

Syntax SCPI.CALCulate.FP(1-1).TRACe(1-4).MATH.FUNcTion = <string>  
 <string> = SCPI.CALCulate.FP(1-1).TRACe(1-4).MATH.FUNcTion

Description Sets/reads math operation type

Variable

	Param
NORMal(Preset value)	Set math operation type to 'NORMal'
SUBTract	Set math operation type to 'SUBTract'
DIVide	Set math operation type to 'DIVide'
ADD	Set math operation type to 'ADD'
MULTiply	Set math operation type to 'MULTiply'

Equivalent key FP Menu -> Trace View -> Data Math

**SCPI.CALCulate.FP(1-1).TRACe(1-4).MATH.MEMorize**

Syntax SCPI.CALCulate.FP(1-1).TRACe(1-4).MATH.MEMorize

COM Object Reference  
**SCPI.CALCulate.FP(1-1).TRACe(1-4).PARAmeter**

Description Copy data to memory (No Read)  
Equivalent key No equivalent key is available on the front panel.

**SCPI.CALCulate.FP(1-1).TRACe(1-4).PARAmeter**

<string> = SCPI.CALCulate.FP(1-1).TRACe(1-4).PARAmeter

Description Reads the trace parameter. (Query Only)  
Equivalent key No equivalent key is available on the front panel.

**SCPI.CALCulate.FP(1-1).TRACe(1-4).REFerence.FREQue  
ncy**

Syntax SCPI.CALCulate.FP(1-1).TRACe(1-4).REFerence.FREQuency = <double>  
<double> = SCPI.CALCulate.FP(1-1).TRACe(1-4).REFerence.FREQuency

Description Sets/reads the frequency reference.

Variable

	<b>&lt;Double&gt;</b>
Range	-50G to 50G
Preset value	0
Unit	Hz
Resolution	-

Equivalent key FP Menu -> Format -> Frequency Reference

**SCPI.CALCulate.FP(1-1).TRACe(1-4).SAPerture**

Syntax SCPI.CALCulate.FP(1-1).TRACe(1-4).SAPerture = <double>  
<double> = SCPI.CALCulate.FP(1-1).TRACe(1-4).SAPerture

Description Sets/reads the sensitivity aperture value for tuning sensitivity (Hz/V)

Variable

	<b>&lt;Double&gt;</b>
Range	100m to 20
Preset value	1
Unit	%

	<b>&lt;Double&gt;</b>
Resolution	100m

Equivalent key FP Menu -> Format -> Sensitivity Aperture

**SCPI.CALCulate.FP(1-1).TRACe(1-4).SMOothing.APERture**

Syntax SCPI.CALCulate.FP(1-1).TRACe(1-4).SMOothing.APERture = <double>  
 <double> = SCPI.CALCulate.FP(1-1).TRACe(1-4).SMOothing.APERture

Description Sets/reads the smoothing aperture value

Variable

	<b>&lt;Double&gt;</b>
Range	50m to 25
Preset value	1.5
Unit	%
Resolution	10m

Equivalent key FP Menu -> Trace View -> Aperture

**SCPI.CALCulate.FP(1-1).TRACe(1-4).SMOothing.STATe**

Syntax SCPI.CALCulate.FP(1-1).TRACe(1-4).SMOothing.STATe = <boolean>  
 <boolean> = SCPI.CALCulate.FP(1-1).TRACe(1-4).SMOothing.STATe

Description Turns on/off smoothing function

Variable

	<b>Param</b>
True or 1	Set smoothing function to 'ON'
False or 0(Preset value)	Set smoothing function to 'OFF'

Equivalent key FP Menu -> Trace View -> Smoothing

**SCPI.CALCulate.PN(1-1).ALLTrace.LIMit.FAIL**

<boolean> = SCPI.CALCulate.PN(1-1).ALLTrace.LIMit.FAIL

Description Reads out the limit test result (Query Only)

Variable

	<b>Param</b>
True or -1	The limit test result is fail
False or 0(Preset value)	The limit test result is pass

When the limit test is set to OFF, false or 0 is always read out.

Equivalent key No equivalent key is available on the front panel.

### **SCPI.CALCulate.PN(1-1).ALLTrace.MARKer.COUPle.STATe**

Syntax SCPI.CALCulate.PN(1-1).ALLTrace.MARKer.COUPle.STATe = <boolean>  
<boolean> = SCPI.CALCulate.PN(1-1).ALLTrace.MARKer.COUPle.STATe

Description Turns on/off marker coupling function

Variable

	<b>Param</b>
True or 1	Set marker coupling function to 'ON'
False or 0(Preset value)	Set marker coupling function to 'OFF'

Equivalent key No equivalent key is available on the front panel.

### **SCPI.CALCulate.PN(1-1).ALLTrace.MARKer.DISCrete.STATe**

Syntax SCPI.CALCulate.PN(1-1).ALLTrace.MARKer.DISCrete.STATe = <boolean>  
<boolean> = SCPI.CALCulate.PN(1-1).ALLTrace.MARKer.DISCrete.STATe

Description Enables/disables marker discrete function

Variable

	<b>Param</b>
True or -1	Enable marker discrete function
False or 0(Preset value)	Disable marker discrete function

Equivalent key PN Menu -> Marker -> More Functions -> Discrete

**SCPI.CALCulate.PN(1-1).ALLTrace.MARKer.REFerence.NUMBer**

Syntax SCPI.CALCulate.PN(1-1).ALLTrace.MARKer.REFerence.NUMBer = <long>  
 <long> = SCPI.CALCulate.PN(1-1).ALLTrace.MARKer.REFerence.NUMBer

Description Sets/reads marker reference number

Variable

	<Long>
Range	1 to 6
Preset value	1
Unit	-
Resolution	-

Equivalent key PN Menu -> Marker -> More Functions -> Ref Marker

**SCPI.CALCulate.PN(1-1).ALLTrace.MARKer.REFerence.STATe**

Syntax SCPI.CALCulate.PN(1-1).ALLTrace.MARKer.REFerence.STATe = <boolean>  
 <boolean> = SCPI.CALCulate.PN(1-1).ALLTrace.MARKer.REFerence.STATe

Description Turns on/off delta marker mode

Variable

	<b>Param</b>
True or -1	Set delta marker mode to 'ON'
False or 0(Preset value)	Set delta marker mode to 'OFF'

Equivalent key PN Menu -> Marker -> More Functions -> Ref Marker Mode

**SCPI.CALCulate.PN(1-1).DATA.CARRier**

Syntax SCPI.CALCulate.PN(1-1).DATA.CARRier = <variant>  
 <variant> = SCPI.CALCulate.PN(1-1).DATA.CARRier

Description Sets/reads the carrier frequency/power data in phase noise measurement

Variable

	<Variant>
Range	1...2
Preset value	-
Unit	-
Resolution	-

Equivalent key No equivalent key is available on the front panel.

### **SCPI.CALCulate.PN(1-1).DATA.PDATA**

Syntax SCPI.CALCulate.PN(1-1).DATA.PDATA = <variant>  
<variant> = SCPI.CALCulate.PN(1-1).DATA.PDATA

Description Sets/reads the raw power data (dBc)

Variable

	<Variant>
Range	1...1601
Preset value	-
Unit	-
Resolution	-

Equivalent key No equivalent key is available on the front panel.

### **SCPI.CALCulate.PN(1-1).DATA.RDATA**

Syntax SCPI.CALCulate.PN(1-1).DATA.RDATA = <variant>  
<variant> = SCPI.CALCulate.PN(1-1).DATA.RDATA

Description Sets/reads the measurement raw data

Variable

	<Variant>
Range	1...1601
Preset value	-
Unit	-

	<b>&lt;Variant&gt;</b>
Resolution	-

Equivalent key No equivalent key is available on the front panel.

### **SCPI.CALCulate.PN(1-1).DATA.XDATA**

Syntax <variant> = SCPI.CALCulate.PN(1-1).DATA.XDATA

Description Reads the X data (Read Only)

Equivalent key No equivalent key is available on the front panel.

### **SCPI.CALCulate.PN(1-1).TRACe(1-1).ALLMarker.ACTive**

Syntax SCPI.CALCulate.PN(1-1).TRACe(1-1).ALLMarker.ACTive = <long>

<long> = SCPI.CALCulate.PN(1-1).TRACe(1-1).ALLMarker.ACTive

Description Selects active marker

Variable

	<b>&lt;Long&gt;</b>
Range	1 to 6
Preset value	1
Unit	-
Resolution	-

Equivalent key No equivalent key is available on the front panel.

### **SCPI.CALCulate.PN(1-1).TRACe(1-1).ALLMarker.SEARCh.DOMain.X**

Syntax SCPI.CALCulate.PN(1-1).TRACe(1-1).ALLMarker.SEARCh.DOMain.X = <string>

<string> = SCPI.CALCulate.PN(1-1).TRACe(1-1).ALLMarker.SEARCh.DOMain.X

Description Sets/reads marker search range (X-axis)

Variable

	<b>Param</b>
FRANge(Preset value)	Set marker search range (X-axis) to 'FRANge'

	Param
BDMarker	Set marker search range (X-axis) to 'BDMarker'

Equivalent key PN Menu -> Marker Search -> Search Range (X)

### SCPI.CALCulate.PN(1-1).TRACe(1-1).ALLMarker.SEARCh.DOMain.Y

Syntax SCPI.CALCulate.PN(1-1).TRACe(1-1).ALLMarker.SEARCh.DOMain.Y = <string>  
<string> = SCPI.CALCulate.PN(1-1).TRACe(1-1).ALLMarker.SEARCh.DOMain.Y

Description Sets/reads marker search range (Y-axis)

Variable

	Param
FRANge(Preset value)	Set marker search range (Y-axis) to 'FRANge'
BDMarker	Set marker search range (Y-axis) to 'BDMarker'

Equivalent key PN Menu -> Marker Search -> Search Range (Y)

### SCPI.CALCulate.PN(1-1).TRACe(1-1).ALLMarker.SEARCh.PEAK

Syntax SCPI.CALCulate.PN(1-1).TRACe(1-1).ALLMarker.SEARCh.PEAK

Description Execute marker search all (No Read)

Equivalent key PN Menu -> Marker Search -> Peak -> Search Peak All

### SCPI.CALCulate.PN(1-1).TRACe(1-1).BDMarker.X.CENTer

Syntax SCPI.CALCulate.PN(1-1).TRACe(1-1).BDMarker.X.CENTer = <double>  
<double> = SCPI.CALCulate.PN(1-1).TRACe(1-1).BDMarker.X.CENTer

Description Sets/reads the center value of bandmarker X

Variable

	<Double>
Range	-IT to IT



	<b>&lt;Double&gt;</b>
Preset value	0
Unit	-
Resolution	-

Equivalent key  
 PN Menu -> Marker Function -> Band Marker X -> Center  
 PN Menu -> Marker Search -> Band Marker X -> Center

**SCPI.CALCulate.PN(1-1).TRACe(1-1).BDMarker.X.SPAN**

Syntax  
 SCPI.CALCulate.PN(1-1).TRACe(1-1).BDMarker.X.SPAN = <double>  
 <double> = SCPI.CALCulate.PN(1-1).TRACe(1-1).BDMarker.X.SPAN

Description  
 Sets/reads the span value of bandmarker X

Variable

	<b>&lt;Double&gt;</b>
Range	0 to 2T
Preset value	2T
Unit	-
Resolution	-

Equivalent key  
 PN Menu -> Marker Function -> Band Marker X -> Span  
 PN Menu -> Marker Search -> Band Marker X -> Span

**SCPI.CALCulate.PN(1-1).TRACe(1-1).BDMarker.X.STARt**

Syntax  
 SCPI.CALCulate.PN(1-1).TRACe(1-1).BDMarker.X.STARt = <double>  
 <double> = SCPI.CALCulate.PN(1-1).TRACe(1-1).BDMarker.X.STARt

Description  
 Sets/reads the start value of bandmarker X

Variable

	<b>&lt;Double&gt;</b>
Range	-1T to 1T
Preset value	-1T
Unit	-
Resolution	-

**SCPI.CALCulate.PN(1-1).TRACe(1-1).BDMarker.X.STATe**

Equivalent key PN Menu -> Marker Function -> Band Marker X -> Start  
 PN Menu -> Marker Search -> Band Marker X -> Start

**SCPI.CALCulate.PN(1-1).TRACe(1-1).BDMarker.X.STATe**

Syntax SCPI.CALCulate.PN(1-1).TRACe(1-1).BDMarker.X.STATe = <boolean>  
 <boolean> = SCPI.CALCulate.PN(1-1).TRACe(1-1).BDMarker.X.STATe

Description Turns on/off bandmarker X

Variable

	Param
True or -1	Set bandmarker X mode to 'ON'
False or 0(Preset value)	Set bandmarker X mode to 'OFF'

Equivalent key PN Menu -> Marker Function -> Band Marker X -> Band Marker X  
 PN Menu -> Marker Search -> Band Marker X -> Band Marker X

**SCPI.CALCulate.PN(1-1).TRACe(1-1).BDMarker.X.STOP**

Syntax SCPI.CALCulate.PN(1-1).TRACe(1-1).BDMarker.X.STOP = <double>  
 <double> = SCPI.CALCulate.PN(1-1).TRACe(1-1).BDMarker.X.STOP

Description Sets/reads the stop value of bandmarker X

Variable

	<Double>
Range	-1T to 1T
Preset value	1T
Unit	-
Resolution	-

Equivalent key PN Menu -> Marker Function -> Band Marker X -> Stop  
 PN Menu -> Marker Search -> Band Marker X -> Stop

**SCPI.CALCulate.PN(1-1).TRACe(1-1).BDMarker.Y.CENTer**

Syntax SCPI.CALCulate.PN(1-1).TRACe(1-1).BDMarker.Y.CENTer = <double>

<double> = SCPI.CALCulate.PN(1-1).TRACe(1-1).BDMarker.Y.CENTer

Description Sets/reads the center value of bandmarker Y

Variable

	<Double>
Range	-1T to 1T
Preset value	0
Unit	-
Resolution	-

Equivalent key PN Menu -> Marker Function -> Band Marker Y -> Center  
 PN Menu -> Marker Search -> Band Marker Y -> Center

**SCPI.CALCulate.PN(1-1).TRACe(1-1).BDMarker.Y.SPAN**

Syntax SCPI.CALCulate.PN(1-1).TRACe(1-1).BDMarker.Y.SPAN = <double>  
 <double> = SCPI.CALCulate.PN(1-1).TRACe(1-1).BDMarker.Y.SPAN

Description Sets/reads the span value of bandmarker Y

Variable

	<Double>
Range	0 to 2T
Preset value	2T
Unit	-
Resolution	-

Equivalent key PN Menu -> Marker Function -> Band Marker Y -> Span  
 PN Menu -> Marker Search -> Band Marker Y -> Span

**SCPI.CALCulate.PN(1-1).TRACe(1-1).BDMarker.Y.STARt**

Syntax SCPI.CALCulate.PN(1-1).TRACe(1-1).BDMarker.Y.STARt = <double>  
 <double> = SCPI.CALCulate.PN(1-1).TRACe(1-1).BDMarker.Y.STARt

Description Sets/reads the start value of bandmarker Y

Variable

	<b>&lt;Double&gt;</b>
Range	-1T to 1T
Preset value	-1T
Unit	-
Resolution	-

Equivalent key

PN Menu -> Marker Function -> Band Marker Y -> Start

PN Menu -> Marker Search -> Band Marker Y -> Start

### **SCPI.CALCulate.PN(1-1).TRACe(1-1).BDMarker.Y.STATe**

Syntax

SCPI.CALCulate.PN(1-1).TRACe(1-1).BDMarker.Y.STATe = <boolean>

<boolean> = SCPI.CALCulate.PN(1-1).TRACe(1-1).BDMarker.Y.STATe

Description

Turns on/off bandmarker Y

Variable

	<b>Param</b>
True or -1	Set bandmarker Y mode to 'ON'
False or 0(Preset value)	Set bandmarker Y mode to 'OFF'

Equivalent key

PN Menu -> Marker Function -> Band Marker Y -> Band Marker Y

PN Menu -> Marker Search -> Band Marker Y -> Band Marker Y

### **SCPI.CALCulate.PN(1-1).TRACe(1-1).BDMarker.Y.STOP**

Syntax

SCPI.CALCulate.PN(1-1).TRACe(1-1).BDMarker.Y.STOP = <double>

<double> = SCPI.CALCulate.PN(1-1).TRACe(1-1).BDMarker.Y.STOP

Description

Sets/reads the stop value of bandmarker Y

Variable

	<b>&lt;Double&gt;</b>
Range	-1T to 1T
Preset value	1T
Unit	-

	<Double>
Resolution	-

Equivalent key PN Menu -> Marker Function -> Band Marker Y -> Stop  
 PN Menu -> Marker Search -> Band Marker Y -> Stop

**SCPI.CALCulate.PN(1-1).TRACe(1-1).DATA.COPY**

Syntax SCPI.CALCulate.PN(1-1).TRACe(1-1).DATA.COPY

Description Copies trace data to the user trace (No Query)

Variable

	<Long>
Range	1 to 8
Preset value	-
Unit	-
Resolution	-

Equivalent key PN Menu -> Trace View-> Copy to USER -> Copy to USER1  
 PN Menu -> Trace View-> Copy to USER -> Copy to USER2  
 PN Menu -> Trace View-> Copy to USER -> Copy to USER3  
 PN Menu -> Trace View-> Copy to USER -> Copy to USER4  
 PN Menu -> Trace View-> Copy to USER -> Copy to USER5  
 PN Menu -> Trace View-> Copy to USER -> Copy to USER6  
 PN Menu -> Trace View-> Copy to USER -> Copy to USER7  
 PN Menu -> Trace View-> Copy to USER -> Copy to USER8

**SCPI.CALCulate.PN(1-1).TRACe(1-1).DATA.FDATA**

Syntax SCPI.CALCulate.PN(1-1).TRACe(1-1).DATA.FDATA = <variant>  
 <variant> = SCPI.CALCulate.PN(1-1).TRACe(1-1).DATA.FDATA

Description Set/Get formatted trace data

Variable

	<Variant>
Range	1...1601

	<b>&lt;Variant&gt;</b>
Preset value	-
Unit	-
Resolution	-

Equivalent key No equivalent key is available on the front panel.

### **SCPI.CALCulate.PN(1-1).TRACe(1-1).DATA.FMEMory**

Syntax SCPI.CALCulate.PN(1-1).TRACe(1-1).DATA.FMEMory = <variant>  
 <variant> = SCPI.CALCulate.PN(1-1).TRACe(1-1).DATA.FMEMory

Description Sets/reads formatted memory data

Variable

	<b>&lt;Variant&gt;</b>
Range	1...1601
Preset value	-
Unit	-
Resolution	-

Equivalent key No equivalent key is available on the front panel.

### **SCPI.CALCulate.PN(1-1).TRACe(1-1).DATA.PDATA**

Syntax SCPI.CALCulate.PN(1-1).TRACe(1-1).DATA.PDATA = <variant>  
 <variant> = SCPI.CALCulate.PN(1-1).TRACe(1-1).DATA.PDATA

Description Sets/reads unformatted trace power data (dBc)

Variable

	<b>&lt;Variant&gt;</b>
Range	1...1601
Preset value	-
Unit	-
Resolution	-

Equivalent key No equivalent key is available on the front panel.

### **SCPI.CALCulate.PN(1-1).TRACe(1-1).DATA.PMEMory**

**Syntax** SCPI.CALCulate.PN(1-1).TRACe(1-1).DATA.PMEMory = <variant>  
 <variant> = SCPI.CALCulate.PN(1-1).TRACe(1-1).DATA.PMEMory

**Description** Sets/reads unformatted memory power data (dBc)

**Variable**

	<Variant>
Range	1...1601
Preset value	-
Unit	-
Resolution	-

**Equivalent key** No equivalent key is available on the front panel.

### **SCPI.CALCulate.PN(1-1).TRACe(1-1).DATA.SDATA**

<variant> = SCPI.CALCulate.PN(1-1).TRACe(1-1).DATA.SDATA

**Description** Reads the spurious judgement results (0/1) of trace data (Query Only)

**Equivalent key** No equivalent key is available on the front panel.

### **SCPI.CALCulate.PN(1-1).TRACe(1-1).DATA.SMEMory**

<variant> = SCPI.CALCulate.PN(1-1).TRACe(1-1).DATA.SMEMory

**Description** Reads the spurious judgement results (0/1) of memory data. (Query Only)

**Equivalent key** No equivalent key is available on the front panel.

### **SCPI.CALCulate.PN(1-1).TRACe(1-1).DATA.UDATA**

**Syntax** SCPI.CALCulate.PN(1-1).TRACe(1-1).DATA.UDATA = <variant>  
 <variant> = SCPI.CALCulate.PN(1-1).TRACe(1-1).DATA.UDATA

**Description** Sets/reads unformatted trace data

**Variable**

	<Variant>
Range	1...1601
Preset value	-

	<b>&lt;Variant&gt;</b>
Unit	-
Resolution	-

Equivalent key No equivalent key is available on the front panel.

### **SCPI.CALCulate.PN(1-1).TRACe(1-1).DATA.UMEMory**

Syntax SCPI.CALCulate.PN(1-1).TRACe(1-1).DATA.UMEMory = <variant>  
 <variant> = SCPI.CALCulate.PN(1-1).TRACe(1-1).DATA.UMEMory

Description Sets/reads unformatted memory data

Variable

	<b>&lt;Variant&gt;</b>
Range	1...1601
Preset value	-
Unit	-
Resolution	-

Equivalent key No equivalent key is available on the front panel.

### **SCPI.CALCulate.PN(1-1).TRACe(1-1).FUNCtion.DOMain.X**

Syntax SCPI.CALCulate.PN(1-1).TRACe(1-1).FUNCtion.DOMain.X = <string>  
 <string> = SCPI.CALCulate.PN(1-1).TRACe(1-1).FUNCtion.DOMain.X

Description Sets/reads analysis/search range (X-axis)

Variable

	<b>Param</b>
FRANge	Set analysis/search range (X-axis) to 'FRANge' (full range)
BDMarker(Preset value)	Set analysis/search range (X-axis) to 'BDMarker' (specified range by bandmarker X)

Equivalent key PN Menu -> Marker Function -> Analysis Range (X)



**SCPI.CALCulate.PN(1-1).TRACe(1-1).FUNCTion.DOMain.Y**

**Syntax** SCPI.CALCulate.PN(1-1).TRACe(1-1).FUNCTion.DOMain.Y = <string>  
<string> = SCPI.CALCulate.PN(1-1).TRACe(1-1).FUNCTion.DOMain.Y

**Description** Sets/reads analysis/search range (Y-axis)

**Variable**

	Param
FRANge	Set analysis/search range (Y-axis) to 'FRANge' (full range)
BDMarker(Preset value)	Set analysis/search range (Y-axis) to 'BDMarker' (specified range by bandmarker Y)

**Equivalent key** PN Menu -> Marker Function -> Analysis Range (Y)

**SCPI.CALCulate.PN(1-1).TRACe(1-1).FUNCTion.INTegral.DATA\_Q integ\_noise, freq\_range, rms\_rad, rms\_deg, jitter, residual\_fm**

<double>,<double>,<double>,<double>,<double>,<double> =  
SCPI.CALCulate.PN(1-1).TRACe(1-1).FUNCTion.INTegral.DATA\_Q integ\_noise,  
freq\_range, rms\_rad, rms\_deg, jitter, residual\_fm

**Description** Reads the integrated phase noise, frequency range, RMS noise, RMS jitter, and residual FM of trace data. (Query Only)

**Equivalent key** No equivalent key is available on the front panel.

**SCPI.CALCulate.PN(1-1).TRACe(1-1).FUNCTion.INTegral.MEMory\_Q integ\_noise, freq\_range, rms\_rad, rms\_deg, jitter, residual\_fm**

<double>,<double>,<double>,<double>,<double>,<double> =  
SCPI.CALCulate.PN(1-1).TRACe(1-1).FUNCTion.INTegral.MEMory\_Q integ\_noise,  
freq\_range, rms\_rad, rms\_deg, jitter, residual\_fm

**Description** Reads integrated phase noise, frequency range, RMS noise, RMS jitter, and residual FM of memory data. (Query Only)

**Equivalent key** No equivalent key is available on the front panel.

**SCPI.CALCulate.PN(1-1).TRACe(1-1).FUNCTion.STATistics.DATA\_Q**

**Syntax** SCPI.CALCulate.PN(1-1).TRACe(1-1).FUNCTion.STATistics.DATA\_Q mean, std\_dev,

peak\_to\_peak

Description Reads the results of statistical analysis for the data trace (Read Only)

Examples

```
Dim meas As Double
Dim s_dev As Double
Dim p_p As Double
```

```
SCPI.CALCulate.PN.TRACe.FUNCTION.STATistics.DATA_Q mean, s_dev, p_p
```

Equivalent key No equivalent key is available on the front panel.

### **SCPI.CALCulate.PN(1-1).TRACe(1-1).FUNCTION.STATistics.MEMory\_Q**

Syntax SCPI.CALCulate.PN(1-1).TRACe(1-1).FUNCTION.STATistics.MEMory\_Q mean, std\_dev, peak\_to\_peak

Description Reads the results of statistical analysis for the memory trace (Read Only)

Examples

```
Dim meas As Double
Dim s_dev As Double
Dim p_p As Double
```

```
SCPI.CALCulate.PN.TRACe.FUNCTION.STATistics.MEMory_Q mean, s_dev, p_p
```

Equivalent key No equivalent key is available on the front panel.

### **SCPI.CALCulate.PN(1-1).TRACe(1-1).FUNCTION.TYPE**

Syntax SCPI.CALCulate.PN(1-1).TRACe(1-1).FUNCTION.TYPE = <string>  
<string> = SCPI.CALCulate.PN(1-1).TRACe(1-1).FUNCTION.TYPE

Description Sets/reads analysis type

Variable

	<b>Param</b>
OFF(Preset value)	Set analysis type to 'OFF'
STATistics	Set analysis type to 'STATistics'
INTegral	Set analysis type to 'INTegral'

Equivalent key PN Menu -> Marker Function -> Analysis Type

### **SCPI.CALCulate.PN(1-1).TRACe(1-1).HOLD**

Syntax SCPI.CALCulate.PN(1-1).TRACe(1-1).HOLD = <string>

<string> = SCPI.CALCulate.PN(1-1).TRACe(1-1).HOLD

Description Selects data hold type

Variable

	Param
OFF(Preset value)	Set data hold type to 'OFF'
MAXimum	Set data hold type to 'MAXimum'
MINimum	Set data hold type to 'MINimum'

Equivalent key PN Menu -> Trace View -> Data Hold

**SCPI.CALCulate.PN(1-1).TRACe(1-1).LIMit.FAIL**

<boolean> = SCPI.CALCulate.PN(1-1).TRACe(1-1).LIMit.FAIL

Description Reads out the limit test result (Query Only)

Variable

	Param
True or -1	The limit test result is fail
False or 0(Preset value)	The limit test result is pass

When the limit test is set to OFF, false or 0 is always read out.

Equivalent key No equivalent key is available on the front panel.

**SCPI.CALCulate.PN(1-1).TRACe(1-1).LIMit.LOWER.LDATa**

Syntax SCPI.CALCulate.PN(1-1).TRACe(1-1).LIMit.LOWER.LDATa = <variant>

<variant> = SCPI.CALCulate.PN(1-1).TRACe(1-1).LIMit.LOWER.LDATa

Description Sets/reads the lower limit values of all measurement points

Variable

	<Variant>
Range	1...1601
Preset value	-
Unit	-

	<Variant>
Resolution	-

Equivalent key No equivalent key is available on the front panel.

### **SCPI.CALCulate.PN(1-1).TRACe(1-1).LIMit.LOWer.SEGMent.CLEAr**

Syntax SCPI.CALCulate.PN(1-1).TRACe(1-1).LIMit.LOWer.SEGMent.CLEAr

Description Clears the lower limit line (No Query)

Equivalent key PN Menu -> Display -> Limit Test -> Delete Lower Limit Line

### **SCPI.CALCulate.PN(1-1).TRACe(1-1).LIMit.LOWer.SEGMent.COUNT**

Syntax SCPI.CALCulate.PN(1-1).TRACe(1-1).LIMit.LOWer.SEGMent.COUNT = <long>  
<long> = SCPI.CALCulate.PN(1-1).TRACe(1-1).LIMit.LOWer.SEGMent.COUNT

Description Sets/reads the number of segments in the lower limit line

Variable

	<Long>
Range	1 to 100
Preset value	1
Unit	-
Resolution	-

Equivalent key No equivalent key is available on the front panel.

### **SCPI.CALCulate.PN(1-1).TRACe(1-1).LIMit.LOWer.SEGMent.DATA**

Syntax SCPI.CALCulate.PN(1-1).TRACe(1-1).LIMit.LOWer.SEGMent.DATA = <variant>  
<variant> = SCPI.CALCulate.PN(1-1).TRACe(1-1).LIMit.LOWer.SEGMent.DATA

Description Sets/reads segment data of the lower limit line

Variable

	<b>&lt;Variant&gt;</b>
Range	1...400
Preset value	-
Unit	-
Resolution	-

Equivalent key No equivalent key is available on the front panel.

**SCPI.CALCulate.PN(1-1).TRACe(1-1).LIMit.REPort.DATA**

<variant> = SCPI.CALCulate.PN(1-1).TRACe(1-1).LIMit.REPort.DATA

Description Reads the limit test results of all measurement points in selected traces (Query Only)

Equivalent key No equivalent key is available on the front panel.

**SCPI.CALCulate.PN(1-1).TRACe(1-1).LIMit.STATe**

Syntax SCPI.CALCulate.PN(1-1).TRACe(1-1).LIMit.STATe = <boolean>

<boolean> = SCPI.CALCulate.PN(1-1).TRACe(1-1).LIMit.STATe

Description Turns on/off the limit test function

Variable

	<b>Param</b>
True or -1	Turn on the limit test function mode
False or 0(Preset value)	Turn off the limit test function mode

Equivalent key PN Menu -> Display -> Limit Test -> Limit Test

**SCPI.CALCulate.PN(1-1).TRACe(1-1).LIMit.UPPer.LDATa**

Syntax SCPI.CALCulate.PN(1-1).TRACe(1-1).LIMit.UPPer.LDATa = <variant>

<variant> = SCPI.CALCulate.PN(1-1).TRACe(1-1).LIMit.UPPer.LDATa

Description Sets/reads the upper limit values of all measurement points

Variable

	<Variant>
Range	1...1601
Preset value	-
Unit	-
Resolution	-

Equivalent key

No equivalent key is available on the front panel.

### SCPI.CALCulate.PN(1-1).TRACe(1-1).LIMit.UPPer.SEGMent.CLEAr

Syntax

SCPI.CALCulate.PN(1-1).TRACe(1-1).LIMit.UPPer.SEGMent.CLEAr

Description

Clears the upper limit line (No Query)

Equivalent key

PN Menu -&gt; Display -&gt; Limit Test -&gt; Delete Upper Limit Line

### SCPI.CALCulate.PN(1-1).TRACe(1-1).LIMit.UPPer.SEGMent.COUNT

Syntax

SCPI.CALCulate.PN(1-1).TRACe(1-1).LIMit.UPPer.SEGMent.COUNT = <long>  
 <long> = SCPI.CALCulate.PN(1-1).TRACe(1-1).LIMit.UPPer.SEGMent.COUNT

Description

Sets/reads the number of segments in the upper limit line

Variable

	<Long>
Range	1 to 100
Preset value	1
Unit	-
Resolution	-

Equivalent key

No equivalent key is available on the front panel.

### SCPI.CALCulate.PN(1-1).TRACe(1-1).LIMit.UPPer.SEGMent.DATA

Syntax

SCPI.CALCulate.PN(1-1).TRACe(1-1).LIMit.UPPer.SEGMent.DATA = <variant>  
 <variant> = SCPI.CALCulate.PN(1-1).TRACe(1-1).LIMit.UPPer.SEGMent.DATA

Description Sets/reads segment data of the upper limit line

Variable

	<Variant>
Range	1...400
Preset value	-
Unit	-
Resolution	-

Equivalent key No equivalent key is available on the front panel.

**SCPI.CALCulate.PN(1-1).TRACe(1-1).MARKer(1-6).SEARch.EXECute.LPEak**

Syntax SCPI.CALCulate.PN(1-1).TRACe(1-1).MARKer(1-6).SEARch.EXECute.LPEak

Description Execute marker peak search left (No Read)

Equivalent key PN Menu -> Marker Search -> Peak -> Search Left

**SCPI.CALCulate.PN(1-1).TRACe(1-1).MARKer(1-6).SEARch.EXECute.LTARget**

Syntax SCPI.CALCulate.PN(1-1).TRACe(1-1).MARKer(1-6).SEARch.EXECute.LTARget

Description Execute marker target search left (No Read)

Equivalent key PN Menu -> Marker Search -> Target -> Search Left

**SCPI.CALCulate.PN(1-1).TRACe(1-1).MARKer(1-6).SEARch.EXECute.MAXimum**

Syntax SCPI.CALCulate.PN(1-1).TRACe(1-1).MARKer(1-6).SEARch.EXECute.MAXimum

Description Execute marker search maximum (No Read)

Equivalent key PN Menu -> Marker Search -> Search Max

**SCPI.CALCulate.PN(1-1).TRACe(1-1).MARKer(1-6).SEARch.EXECute.MINimum**

Syntax SCPI.CALCulate.PN(1-1).TRACe(1-1).MARKer(1-6).SEARch.EXECute.MINimum

Description Execute marker search minimum (No Read)

Equivalent key PN Menu -> Marker Search -> Search Min

**SCPI.CALCulate.PN(1-1).TRACe(1-1).MARKer(1-6).SEARch.EXECute.PEAK**

Syntax SCPI.CALCulate.PN(1-1).TRACe(1-1).MARKer(1-6).SEARch.EXECute.PEAK

Description Execute marker peak search (No Read)

Equivalent key PN Menu -> Marker Search -> Peak -> Search Peak

**SCPI.CALCulate.PN(1-1).TRACe(1-1).MARKer(1-6).SEARch.EXECute.RPEak**

Syntax SCPI.CALCulate.PN(1-1).TRACe(1-1).MARKer(1-6).SEARch.EXECute.RPEak

Description Execute marker peak search right (No Read)

Equivalent key PN Menu -> Marker Search -> Peak -> Search Right

**SCPI.CALCulate.PN(1-1).TRACe(1-1).MARKer(1-6).SEARch.EXECute.RTARget**

Syntax SCPI.CALCulate.PN(1-1).TRACe(1-1).MARKer(1-6).SEARch.EXECute.RTARget

Description Execute marker target search right (No Read)

Equivalent key PN Menu -> Marker Search -> Target -> Search Right

**SCPI.CALCulate.PN(1-1).TRACe(1-1).MARKer(1-6).SEARch.EXECute.TARGet**

Syntax SCPI.CALCulate.PN(1-1).TRACe(1-1).MARKer(1-6).SEARch.EXECute.TARGet

Description Execute marker target search (No Read)

Equivalent key PN Menu -> Marker Search -> Target -> Search Target

**SCPI.CALCulate.PN(1-1).TRACe(1-1).MARKer(1-6).SEARch.PEAK.EXCursion**

Syntax SCPI.CALCulate.PN(1-1).TRACe(1-1).MARKer(1-6).SEARch.PEAK.EXCursion =  
<double>

<double> =

SCPI.CALCulate.PN(1-1).TRACe(1-1).MARKer(1-6).SEARch.PEAK.EXCursion

Description Sets/reads the peak excursion value



Variable

	<Double>
Range	0 to 10G
Preset value	0
Unit	-
Resolution	-

Equivalent key

PN Menu -&gt; Marker Search -&gt; Peak -&gt; Peak Excursion

### SCPI.CALCulate.PN(1-1).TRACe(1-1).MARKer(1-6).SEARch.PEAK.POLarity

Syntax

SCPI.CALCulate.PN(1-1).TRACe(1-1).MARKer(1-6).SEARch.PEAK.POLarity =  
<string>

<string> =

SCPI.CALCulate.PN(1-1).TRACe(1-1).MARKer(1-6).SEARch.PEAK.POLarity

Description

Sets/reads the marker peak-search polarity

Variable

	Param
POSitive(Preset value)	Set the marker peak-search polarity to 'POSitive'
NEGative	Set the marker peak-search polarity to 'NEGative'
BOTH	Set the marker peak-search polarity to 'BOTH'

Equivalent key

PN Menu -&gt; Marker Search -&gt; Peak -&gt; Peak Polarity

### SCPI.CALCulate.PN(1-1).TRACe(1-1).MARKer(1-6).SEARch.TARGet.TRANSition

Syntax

SCPI.CALCulate.PN(1-1).TRACe(1-1).MARKer(1-6).SEARch.TARGet.TRANSition =  
<string>

<string> =

SCPI.CALCulate.PN(1-1).TRACe(1-1).MARKer(1-6).SEARch.TARGet.TRANSition

Description

Sets/reads the target transition definition

Variable

	Param
POSitive	Set the target transition definition to 'POSitive'
NEGative	Set the target transition definition to 'NEGative'
BOTH(Preset value)	Set the target transition definition to 'BOTH'

Equivalent key

PN Menu -&gt; Marker Search -&gt; Target -&gt; Target Transition

### SCPI.CALCulate.PN(1-1).TRACe(1-1).MARKer(1-6).SEARch.TARGet.Y

Syntax

SCPI.CALCulate.PN(1-1).TRACe(1-1).MARKer(1-6).SEARch.TARGet.Y = <double>  
 <double> = SCPI.CALCulate.PN(1-1).TRACe(1-1).MARKer(1-6).SEARch.TARGet.Y

Description

Sets/reads the marker target value

Variable

	<Double>
Range	-10G to 10G
Preset value	0
Unit	-
Resolution	-

Equivalent key

PN Menu -&gt; Marker Search -&gt; Target -&gt; Target Value

### SCPI.CALCulate.PN(1-1).TRACe(1-1).MARKer(1-6).SEARch.TRACking.TYPE

Syntax

SCPI.CALCulate.PN(1-1).TRACe(1-1).MARKer(1-6).SEARch.TRACking.TYPE =  
 <string>  
 <string> =  
 SCPI.CALCulate.PN(1-1).TRACe(1-1).MARKer(1-6).SEARch.TRACking.TYPE

Description

Sets/reads the marker tracking type

Variable

	Param
OFF(Preset value)	Set the marker tracking type to 'OFF'

	Param
MAXimum	Set the marker tracking type to 'MAXimum'
MINimum	Set the marker tracking type to 'MINimum'
PEAK	Set the marker tracking type to 'PEAK'
TARGet	Set the marker tracking type to 'TARGet'

Equivalent key PN Menu -> Marker Search -> Tracking

### SCPI.CALCulate.PN(1-1).TRACe(1-1).MARKer(1-6).STATe

Syntax SCPI.CALCulate.PN(1-1).TRACe(1-1).MARKer(1-6).STATe = <boolean>  
<boolean> = SCPI.CALCulate.PN(1-1).TRACe(1-1).MARKer(1-6).STATe

Description Turns on/off a marker

Variable

	Param
True or -1	Set a marker to 'ON'
False or 0(Preset value)	Set a marker to 'OFF'

Equivalent key PN Menu -> Marker -> Clear Marker Menu -> Marker 1

### SCPI.CALCulate.PN(1-1).TRACe(1-1).MARKer(1-6).X

Syntax SCPI.CALCulate.PN(1-1).TRACe(1-1).MARKer(1-6).X = <double>  
<double> = SCPI.CALCulate.PN(1-1).TRACe(1-1).MARKer(1-6).X

Description Sets/reads the marker X value

Variable

	<Double>
Range	-
Preset value	1k
Unit	-
Resolution	-

Equivalent key No equivalent key is available on the front panel.

**SCPI.CALCulate.PN(1-1).TRACe(1-1).MARKer(1-6).Y**

Syntax	<double> = SCPI.CALCulate.PN(1-1).TRACe(1-1).MARKer(1-6).Y
Description	Reads the marker Y value (Read Only)
Equivalent key	No equivalent key is available on the front panel.

**SCPI.CALCulate.PN(1-1).TRACe(1-1).MATH.FUNCtion**

Syntax	SCPI.CALCulate.PN(1-1).TRACe(1-1).MATH.FUNCtion = <string> <string> = SCPI.CALCulate.PN(1-1).TRACe(1-1).MATH.FUNCtion
Description	Selects math operation type
Variable	

	Param
NORMal(Preset value)	Set math operation type to 'NORMal'
SUBTract	Set math operation type to 'SUBTract'
DIVide	Set math operation type to 'DIVide'
ADD	Set math operation type to 'ADD'
MULTiply	Set math operation type to 'MULTiply'

Equivalent key	PN Menu -> Trace View -> Data Math
----------------	------------------------------------

**SCPI.CALCulate.PN(1-1).TRACe(1-1).MATH.MEMorize**

Syntax	SCPI.CALCulate.PN(1-1).TRACe(1-1).MATH.MEMorize
Description	Copy data to memory (No Read)
Equivalent key	No equivalent key is available on the front panel.

**SCPI.CALCulate.PN(1-1).TRACe(1-1).SMOothing.APERture**

Syntax	SCPI.CALCulate.PN(1-1).TRACe(1-1).SMOothing.APERture = <double> <double> = SCPI.CALCulate.PN(1-1).TRACe(1-1).SMOothing.APERture
Description	Sets/reads the smoothing aperture value

Variable

	<Double>
Range	50m to 25
Preset value	1.5
Unit	%
Resolution	10m

Equivalent key PN Menu -> Trace View -> Aperture

**SCPI.CALCulate.PN(1-1).TRACe(1-1).SMOothing.STATe**

Syntax SCPI.CALCulate.PN(1-1).TRACe(1-1).SMOothing.STATe = <boolean>  
 <boolean> = SCPI.CALCulate.PN(1-1).TRACe(1-1).SMOothing.STATe

Description Turns on/off smoothing function

Variable

	Param
True or -1	Set smoothing function to 'ON'
False or 0(Preset value)	Set smoothing function to 'OFF'

Equivalent key PN Menu -> Trace View -> Smoothing

**SCPI.CALCulate.PN(1-1).TRACe(1-1).SPURious.OMISsion**

Syntax SCPI.CALCulate.PN(1-1).TRACe(1-1).SPURious.OMISsion = <boolean>  
 <boolean> = SCPI.CALCulate.PN(1-1).TRACe(1-1).SPURious.OMISsion

Description Turns on/off spurious omission function

Variable

	Param
True or -1	Set spurious omission function to 'ON'
False or 0(Preset value)	Set spurious omission function to 'OFF'

Equivalent key PN Menu -> Trace View -> Spurious -> Omit

**SCPI.CALCulate.PN(1-1).TRACe(1-1).SPURious.POWer**

**Syntax** SCPI.CALCulate.PN(1-1).TRACe(1-1).SPURious.POWer = <boolean>  
<boolean> = SCPI.CALCulate.PN(1-1).TRACe(1-1).SPURious.POWer

**Description** Turns on/off the spurious power value display

**Variable**

	<b>Param</b>
True or -1	Turn on the spurious power value display mode
False or 0(Preset value)	Turn off the spurious power value display mode

**Equivalent key** PN Menu -> Trace View -> Spurious -> Power (dBc)

**SCPI.CALCulate.PN(1-1).TRACe(1-1).SPURious.THReshold.TABLE.CLEAr**

**Syntax** SCPI.CALCulate.PN(1-1).TRACe(1-1).SPURious.THReshold.TABLE.CLEAr

**Description** Clears the threshold data (No Query)

**Equivalent key** PN Menu -> Trace View -> Spurious -> Clear Threshold Table

**SCPI.CALCulate.PN(1-1).TRACe(1-1).SPURious.THReshold.TABLE.COUNT**

**Syntax** SCPI.CALCulate.PN(1-1).TRACe(1-1).SPURious.THReshold.TABLE.COUNT = <long>  
<long> = SCPI.CALCulate.PN(1-1).TRACe(1-1).SPURious.THReshold.TABLE.COUNT

**Description** Sets/reads the number of segments in the threshold data

**Variable**

	<b>&lt;Long&gt;</b>
Range	1 to 20
Preset value	1
Unit	-
Resolution	-

**Equivalent key** No equivalent key is available on the front panel.

**SCPI.CALCulate.PN(1-1).TRACe(1-1).SPURious.THReshold.TABLe.DATA**

**Syntax** SCPI.CALCulate.PN(1-1).TRACe(1-1).SPURious.THReshold.TABLe.DATA = <variant>  
 <variant> = SCPI.CALCulate.PN(1-1).TRACe(1-1).SPURious.THReshold.TABLe.DATA

**Description** Sets/reads the threshold data

**Variable**

	<Variant>
Range	1...60
Preset value	-
Unit	-
Resolution	-

**Equivalent key** No equivalent key is available on the front panel.

**SCPI.CALCulate.SP(1-1).ALLTrace.LIMit.FAIL**

<boolean> = SCPI.CALCulate.SP(1-1).ALLTrace.LIMit.FAIL

**Description** Reads out the limit test result (Query Only)

**Variable**

	Param
True or -1	The limit test result is fail
False or 0(Preset value)	The limit test result is pass

When the limit test is set to OFF, false or 0 is always read out.

**Equivalent key** No equivalent key is available on the front panel.

**SCPI.CALCulate.SP(1-1).ALLTrace.MARKer.COUPle.STATe**

**Syntax** SCPI.CALCulate.SP(1-1).ALLTrace.MARKer.COUPle.STATe = <boolean>  
 <boolean> = SCPI.CALCulate.SP(1-1).ALLTrace.MARKer.COUPle.STATe

**Description** Turns on/off marker coupling function

Variable

	<b>Param</b>
True or -1	Set marker coupling function to 'ON'
False or 0(Preset value)	Set marker coupling function to 'OFF'

Equivalent key No equivalent key is available on the front panel.

**SCPI.CALCulate.SP(1-1).ALLTrace.MARKer.DISCrete.STATe**

Syntax SCPI.CALCulate.SP(1-1).ALLTrace.MARKer.DISCrete.STATe = <boolean>  
 <boolean> = SCPI.CALCulate.SP(1-1).ALLTrace.MARKer.DISCrete.STATe

Description Turns on/off marker discrete function

Variable

	<b>Param</b>
True or -1	Enable marker discrete function
False or 0(Preset value)	Disable marker discrete function

Equivalent key SP Menu -> Marker -> More Functions -> Discrete

**SCPI.CALCulate.SP(1-1).ALLTrace.MARKer.REFerence.NUMBer**

Syntax SCPI.CALCulate.SP(1-1).ALLTrace.MARKer.REFerence.NUMBer = <long>  
 <long> = SCPI.CALCulate.SP(1-1).ALLTrace.MARKer.REFerence.NUMBer

Description Sets/reads marker reference number

Variable

	<b>&lt;Long&gt;</b>
Range	1 to 6
Preset value	1
Unit	-
Resolution	-



Equivalent key SP Menu -> Marker -> More Functions -> Ref Marker

## SCPI.CALCulate.SP(1-1).ALLTrace.MARKer.REFerence.STATe

Syntax SCPI.CALCulate.SP(1-1).ALLTrace.MARKer.REFerence.STATe = <boolean>  
<boolean> = SCPI.CALCulate.SP(1-1).ALLTrace.MARKer.REFerence.STATe

Description Turns on/off delta marker mode

Variable

	Param
True or -1	Set delta marker mode to 'ON'
False or 0(Preset value)	Set delta marker mode to 'OFF'

Equivalent key SP Menu -> Marker -> More Functions -> Ref Marker Mode

## SCPI.CALCulate.SP(1-1).DATA.RDATa

Syntax SCPI.CALCulate.SP(1-1).DATA.RDATa = <variant>  
<variant> = SCPI.CALCulate.SP(1-1).DATA.RDATa

Description Sets/reads the measurement raw data

Variable

	<Variant>
Range	1...1024
Preset value	-
Unit	-
Resolution	-

Equivalent key No equivalent key is available on the front panel.

## SCPI.CALCulate.SP(1-1).DATA.XDATa

Syntax <variant> = SCPI.CALCulate.SP(1-1).DATA.XDATa

Description Reads X-axis data (Read Only)

Equivalent key No equivalent key is available on the front panel.

**SCPI.CALCulate.SP(1-1).TRACe(1-1).ALLMarker.ACTive**

Syntax SCPI.CALCulate.SP(1-1).TRACe(1-1).ALLMarker.ACTive = <long>  
 <long> = SCPI.CALCulate.SP(1-1).TRACe(1-1).ALLMarker.ACTive

Description Selects active marker

Variable

	<b>&lt;Long&gt;</b>
Range	1 to 6
Preset value	1
Unit	-
Resolution	-

Equivalent key No equivalent key is available on the front panel.

**SCPI.CALCulate.SP(1-1).TRACe(1-1).ALLMarker.SEARch.DOMain.X**

Syntax SCPI.CALCulate.SP(1-1).TRACe(1-1).ALLMarker.SEARch.DOMain.X = <string>  
 <string> = SCPI.CALCulate.SP(1-1).TRACe(1-1).ALLMarker.SEARch.DOMain.X

Description Sets/reads marker search range (X-axis)

Variable

	<b>Param</b>
FRANge(Preset value)	Set marker search range (X-axis) to 'FRANge' (full range)
BDMarker	Set marker search range (X-axis) to 'BDMarker' (specified range by bandmarker X)

Equivalent key SP Menu -> Marker Search -> Search Range (X)

**SCPI.CALCulate.SP(1-1).TRACe(1-1).ALLMarker.SEARch.DOMain.Y**

Syntax SCPI.CALCulate.SP(1-1).TRACe(1-1).ALLMarker.SEARch.DOMain.Y = <string>  
 <string> = SCPI.CALCulate.SP(1-1).TRACe(1-1).ALLMarker.SEARch.DOMain.Y

Description Sets/reads marker search range (Y-axis)

Variable

	Param
FRANge(Preset value)	Set marker search range (Y-axis) to 'FRANge' (full range)
BDMarker	Set marker search range (Y-axis) to 'BDMarker' (specified range by bandmarker Y)

Equivalent key SP Menu -> Marker Search -> Search Range (Y)

**SCPI.CALCulate.SP(1-1).TRACe(1-1).ALLMarker.SEARCh.PEAK**

Syntax SCPI.CALCulate.SP(1-1).TRACe(1-1).ALLMarker.SEARCh.PEAK

Description Execute marker search all (No Read)

Equivalent key SP Menu -> Marker Search -> Peak -> Search Peak All

**SCPI.CALCulate.SP(1-1).TRACe(1-1).BDMarker.X.CENTe  
r**

Syntax SCPI.CALCulate.SP(1-1).TRACe(1-1).BDMarker.X.CENTer = <double>boolean  
 <double> = SCPI.CALCulate.SP(1-1).TRACe(1-1).BDMarker.X.CENTer

Description Sets/reads the center value of bandmarker X

Variable

	<Double>
Range	-IT to IT
Preset value	0
Unit	-
Resolution	-

Equivalent key SP Menu -> Marker Function -> Band Marker X -> Center

SP Menu -> Marker Search -> Band Marker X -> Center

**SCPI.CALCulate.SP(1-1).TRACe(1-1).BDMarker.X.SPAN**

Syntax SCPI.CALCulate.SP(1-1).TRACe(1-1).BDMarker.X.SPAN = <double>  
 <double> = SCPI.CALCulate.SP(1-1).TRACe(1-1).BDMarker.X.SPAN

Description Sets/reads the span value of bandmarker X

Variable

	<b>&lt;Double&gt;</b>
Range	0 to 2T
Preset value	2T
Unit	-
Resolution	-

Equivalent key SP Menu -> Marker Function -> Band Marker X -> Span

SP Menu -> Marker Search -> Band Marker X -> Span

### **SCPI.CALCulate.SP(1-1).TRACe(1-1).BDMarker.X.START**

Syntax SCPI.CALCulate.SP(1-1).TRACe(1-1).BDMarker.X.START = <double>

<double> = SCPI.CALCulate.SP(1-1).TRACe(1-1).BDMarker.X.START

Description Sets/reads the start value of bandmarker X

Variable

	<b>&lt;Double&gt;</b>
Range	-1T to 1T
Preset value	-1T
Unit	-
Resolution	-

Equivalent key SP Menu -> Marker Function -> Band Marker X -> Start

SP Menu -> Marker Search -> Band Marker X -> Start

### **SCPI.CALCulate.SP(1-1).TRACe(1-1).BDMarker.X.STATe**

Syntax SCPI.CALCulate.SP(1-1).TRACe(1-1).BDMarker.X.STATe = <boolean>

<boolean> = SCPI.CALCulate.SP(1-1).TRACe(1-1).BDMarker.X.STATe

Description Turns on/off bandmarker X

Variable

	<b>Param</b>
True or -1	Set bandmarker X function to 'ON'
False or 0(Preset value)	Set bandmarker X function to 'OFF'

Equivalent key

SP Menu -> Marker Function -> Band Marker X -> Band Marker X  
 SP Menu -> Marker Search -> Band Marker X -> Band Marker X

**SCPI.CALCulate.SP(1-1).TRACe(1-1).BDMarker.X.STOP**

Syntax

SCPI.CALCulate.SP(1-1).TRACe(1-1).BDMarker.X.STOP = <double>  
 <double> = SCPI.CALCulate.SP(1-1).TRACe(1-1).BDMarker.X.STOP

Description

Sets/reads the stop value of bandmarker X

Variable

	<b>&lt;Double&gt;</b>
Range	-1T to 1T
Preset value	1T
Unit	-
Resolution	-

Equivalent key

SP Menu -> Marker Function -> Band Marker X -> Stop  
 SP Menu -> Marker Search -> Band Marker X -> Stop

**SCPI.CALCulate.SP(1-1).TRACe(1-1).BDMarker.Y.CENTe  
 r**

Syntax

SCPI.CALCulate.SP(1-1).TRACe(1-1).BDMarker.Y.CENTer = <double>  
 <double> = SCPI.CALCulate.SP(1-1).TRACe(1-1).BDMarker.Y.CENTer

Description

Sets/reads the center value of bandmarker Y

Variable

	<b>&lt;Double&gt;</b>
Range	-1T to 1T
Preset value	0

	<b>&lt;Double&gt;</b>
Unit	-
Resolution	-

Equivalent key SP Menu -> Marker Function -> Band Marker Y -> Center

SP Menu -> Marker Search -> Band Marker Y -> Center

### **SCPI.CALCulate.SP(1-1).TRACe(1-1).BDMarker.Y.SPAN**

Syntax SCPI.CALCulate.SP(1-1).TRACe(1-1).BDMarker.Y.SPAN = <double>

<double> = SCPI.CALCulate.SP(1-1).TRACe(1-1).BDMarker.Y.SPAN

Description Sets/reads the span value of bandmarker Y

Variable

	<b>&lt;Double&gt;</b>
Range	0 to 2T
Preset value	2T
Unit	-
Resolution	-

Equivalent key SP Menu -> Marker Function -> Band Marker Y -> Span

SP Menu -> Marker Search -> Band Marker Y -> Span

### **SCPI.CALCulate.SP(1-1).TRACe(1-1).BDMarker.Y.START**

Syntax SCPI.CALCulate.SP(1-1).TRACe(1-1).BDMarker.Y.START = <double>

<double> = SCPI.CALCulate.SP(1-1).TRACe(1-1).BDMarker.Y.START

Description Sets/reads the start value of bandmarker Y

Variable

	<b>&lt;Double&gt;</b>
Range	-1T to 1T
Preset value	-1T
Unit	-
Resolution	-

Equivalent key SP Menu -> Marker Function -> Band Marker Y -> Start  
 SP Menu -> Marker Search -> Band Marker Y -> Start

### SCPI.CALCulate.SP(1-1).TRACe(1-1).BDMarker.Y.STATe

Syntax SCPI.CALCulate.SP(1-1).TRACe(1-1).BDMarker.Y.STATe = <boolean>  
 <boolean> = SCPI.CALCulate.SP(1-1).TRACe(1-1).BDMarker.Y.STATe

Description Turns on/off bandmarker Y

Variable

	Param
True or -1	Set bandmarker Y function to 'ON'
False or 0(Preset value)	Set bandmarker Y function to 'OFF'

Equivalent key SP Menu -> Marker Function -> Band Marker Y -> Band Marker Y  
 SP Menu -> Marker Search -> Band Marker Y -> Band Marker Y

### SCPI.CALCulate.SP(1-1).TRACe(1-1).BDMarker.Y.STOP

Syntax SCPI.CALCulate.SP(1-1).TRACe(1-1).BDMarker.Y.STOP = <double>  
 <double> = SCPI.CALCulate.SP(1-1).TRACe(1-1).BDMarker.Y.STOP

Description Sets/reads the stop value of bandmarker Y

Variable

	<Double>
Range	-1T to 1T
Preset value	1T
Unit	-
Resolution	-

Equivalent key SP Menu -> Marker Function -> Band Marker Y -> Stop  
 SP Menu -> Marker Search -> Band Marker Y -> Stop

### SCPI.CALCulate.SP(1-1).TRACe(1-1).DATA.COPY

Syntax SCPI.CALCulate.SP(1-1).TRACe(1-1).DATA.COPY

Description Copies trace data to the user trace (No Query)

COM Object Reference  
**SCPI.CALCulate.SP(1-1).TRACe(1-1).DATA.FDATA**

Variable

	<b>&lt;Long&gt;</b>
Range	1 to 8
Preset value	-
Unit	-
Resolution	-

Equivalent key

SP Menu -> Trace View-> Copy to USER -> Copy to USER1  
 SP Menu -> Trace View-> Copy to USER -> Copy to USER2  
 SP Menu -> Trace View-> Copy to USER -> Copy to USER3  
 SP Menu -> Trace View-> Copy to USER -> Copy to USER4  
 SP Menu -> Trace View-> Copy to USER -> Copy to USER5  
 SP Menu -> Trace View-> Copy to USER -> Copy to USER6  
 SP Menu -> Trace View-> Copy to USER -> Copy to USER7  
 SP Menu -> Trace View-> Copy to USER -> Copy to USER8

**SCPI.CALCulate.SP(1-1).TRACe(1-1).DATA.FDATA**

Syntax

SCPI.CALCulate.SP(1-1).TRACe(1-1).DATA.FDATA = <variant>  
 <variant> = SCPI.CALCulate.SP(1-1).TRACe(1-1).DATA.FDATA

Description

Sets/reads formatted trace data

Variable

	<b>&lt;Variant&gt;</b>
Range	1...1024
Preset value	-
Unit	-
Resolution	-

Equivalent key

No equivalent key is available on the front panel.

**SCPI.CALCulate.SP(1-1).TRACe(1-1).DATA.FMEMory**

Syntax

SCPI.CALCulate.SP(1-1).TRACe(1-1).DATA.FMEMory = <variant>  
 <variant> = SCPI.CALCulate.SP(1-1).TRACe(1-1).DATA.FMEMory

Description

Sets/reads formatted memory data



Variable

	<Variant>
Range	1...1024
Preset value	-
Unit	-
Resolution	-

Equivalent key No equivalent key is available on the front panel.

**SCPI.CALCulate.SP(1-1).TRACe(1-1).DATA.UDATa**

Syntax SCPI.CALCulate.SP(1-1).TRACe(1-1).DATA.UDATa = <variant>  
 <variant> = SCPI.CALCulate.SP(1-1).TRACe(1-1).DATA.UDATa

Description Sets/reads unformatted trace data

Variable

	<Variant>
Range	1...1024
Preset value	-
Unit	-
Resolution	-

Equivalent key No equivalent key is available on the front panel.

**SCPI.CALCulate.SP(1-1).TRACe(1-1).DATA.UMEMory**

Syntax SCPI.CALCulate.SP(1-1).TRACe(1-1).DATA.UMEMory = <variant>  
 <variant> = SCPI.CALCulate.SP(1-1).TRACe(1-1).DATA.UMEMory

Description Sets/reads unformatted memory data

Variable

	<Variant>
Range	1...1024
Preset value	-
Unit	-

	<Variant>
Resolution	-

Equivalent key No equivalent key is available on the front panel.

### **SCPI.CALCulate.SP(1-1).TRACe(1-1).FORMat**

Syntax SCPI.CALCulate.SP(1-1).TRACe(1-1).FORMat = <string>  
 <string> = SCPI.CALCulate.SP(1-1).TRACe(1-1).FORMat

Description Selects spectrum monitor mode format

Variable

	<b>Param</b>
DBM(Preset value)	Set SP format to 'DBM' (dBm)
DBV	Set SP format to 'DBV' (dBV)
WATT	Set SP format to 'WATT' (Watt)
VOLT	Set SP format to 'VOLT' (volt)
DBMHz	Set SP format to 'DBMHz' (dBm/Hz)
DBVHz	Set SP format to 'DBVHz' (dBV/Hz)
WHZ	Set SP format to 'WHZ' (W/Hz)
VHZ	Set SP format to 'VHZ' ( $V/\sqrt{\text{Hz}}$ )

Equivalent key SP Menu -> Format -> Format

### **SCPI.CALCulate.SP(1-1).TRACe(1-1).FUNCTion.DOMain.X**

Syntax SCPI.CALCulate.SP(1-1).TRACe(1-1).FUNCTion.DOMain.X = <string>  
 <string> = SCPI.CALCulate.SP(1-1).TRACe(1-1).FUNCTion.DOMain.X

Description Sets/reads analysis/search range (X-axis)

Variable

	<b>Param</b>
FRANge	Set analysis/search range (X-axis) to 'FRANge' (full range)

	Param
BDMarker(Preset value)	Set analysis/search range (X-axis) to 'BDMarker' (specified range by bandmarker X)

Equivalent key SP Menu -> Marker Function -> Analysis Range (X)

## SCPI.CALCulate.SP(1-1).TRACe(1-1).FUNCtion.DOMain.Y

Syntax SCPI.CALCulate.SP(1-1).TRACe(1-1).FUNCtion.DOMain.Y = <string>  
<string> = SCPI.CALCulate.SP(1-1).TRACe(1-1).FUNCtion.DOMain.Y

Description Sets/reads analysis/search range (Y-axis)

Variable

	Param
FRANge	Set analysis/search range (Y-axis) to 'FRANge' (full range)
BDMarker(Preset value)	Set analysis/search range (Y-axis) to 'BDMarker' (specified range by bandmarker Y)

Equivalent key SP Menu -> Marker Function -> Analysis Range (Y)

## SCPI.CALCulate.SP(1-1).TRACe(1-1).FUNCtion.STATistics.DATA\_Q

Syntax SCPI.CALCulate.SP(1-1).TRACe(1-1).FUNCtion.STATistics.DATA\_Q mean, std\_dev, peak\_to\_peak

Description Reads the results of statistical analysis for the data trace (Read Only)

Examples

```
Dim meas As Double
Dim s_dev As Double
Dim p_p As Double
```

```
SCPI.CALCulate.SP.TRACe.FUNCtion.STATistics.DATA_Q mean, s_dev, p_p
```

Equivalent key No equivalent key is available on the front panel.

## SCPI.CALCulate.SP(1-1).TRACe(1-1).FUNCtion.STATistics.MEMory\_Q

Syntax SCPI.CALCulate.SP(1-1).TRACe(1-1).FUNCtion.STATistics.MEMory\_Q mean, std\_dev, peak\_to\_peak

Description Reads the results of statistical analysis for the memory trace (Read Only)

## Examples

```
Dim meas As Double
Dim s_dev As Double
Dim p_p As Double
```

```
SCPI.CALCulate.SP.TRACe.FUNction.STATistics.MEMory_Q mean, s_dev,
p_p
```

## Equivalent key

No equivalent key is available on the front panel.

**SCPI.CALCulate.SP(1-1).TRACe(1-1).FUNction.TYPE**

## Syntax

SCPI.CALCulate.SP(1-1).TRACe(1-1).FUNction.TYPE = <string>

<string> = SCPI.CALCulate.SP(1-1).TRACe(1-1).FUNction.TYPE

## Description

Sets/reads analysis type

## Variable

	<b>Param</b>
OFF(Preset value)	Set analysis type to 'OFF'
STATistics	Set analysis type to 'STATistics'

## Equivalent key

SP Menu -> Marker Function -> Analysis Type

**SCPI.CALCulate.SP(1-1).TRACe(1-1).HOLD**

## Syntax

SCPI.CALCulate.SP(1-1).TRACe(1-1).HOLD = <string>

<string> = SCPI.CALCulate.SP(1-1).TRACe(1-1).HOLD

## Description

Selects data hold type

## Variable

	<b>Param</b>
OFF(Preset value)	Set data hold type to 'OFF'
MAXimum	Set data hold type to 'MAXimum'
MINimum	Set data hold type to 'MINimum'

## Equivalent key

SP Menu -> Trace View -> Data Hold

**SCPI.CALCulate.SP(1-1).TRACe(1-1).LIMit.FAIL**

<boolean> = SCPI.CALCulate.SP(1-1).TRACe(1-1).LIMit.FAIL

## Description

Reads out the limit test result (Query Only)

Variable

	Param
True or -1	The limit test result is fail
False or 0(Preset value)	The limit test result is pass

When the limit test is set to OFF, false or 0 is always read out.

Equivalent key

No equivalent key is available on the front panel.

**SCPI.CALCulate.SP(1-1).TRACe(1-1).LIMit.LOWer.LDATa**

Syntax

SCPI.CALCulate.SP(1-1).TRACe(1-1).LIMit.LOWer.LDATa = <variant>  
 <variant> = SCPI.CALCulate.SP(1-1).TRACe(1-1).LIMit.LOWer.LDATa

Description

Sets/reads the lower limit values of all measurement points

Variable

	<Variant>
Range	1...1024
Preset value	-
Unit	-
Resolution	-

Equivalent key

No equivalent key is available on the front panel.

**SCPI.CALCulate.SP(1-1).TRACe(1-1).LIMit.LOWer.SEGMent.CLEAr**

Syntax

SCPI.CALCulate.SP(1-1).TRACe(1-1).LIMit.LOWer.SEGMent.CLEAr

Description

Clears the lower limit line (No Query)

Equivalent key

SP Menu -> Display -> Limit Test -> Delete Lower Limit Line

**SCPI.CALCulate.SP(1-1).TRACe(1-1).LIMit.LOWer.SEGMent.COUNT**

Syntax

SCPI.CALCulate.SP(1-1).TRACe(1-1).LIMit.LOWer.SEGMent.COUNT = <long>  
 <long> = SCPI.CALCulate.SP(1-1).TRACe(1-1).LIMit.LOWer.SEGMent.COUNT

Description Sets/reads the number of segments in the lower limit line

Variable

	<Long>
Range	1 to 100
Preset value	1
Unit	-
Resolution	-

Equivalent key No equivalent key is available on the front panel.

### **SCPI.CALCulate.SP(1-1).TRACe(1-1).LIMit.LOWer.SEGMent.DATA**

Syntax SCPI.CALCulate.SP(1-1).TRACe(1-1).LIMit.LOWer.SEGMent.DATA = <variant>

<variant> = SCPI.CALCulate.SP(1-1).TRACe(1-1).LIMit.LOWer.SEGMent.DATA

Description Sets/reads segment data of the lower limit line

Variable

	<Variant>
Range	1..400
Preset value	-
Unit	-
Resolution	-

Equivalent key No equivalent key is available on the front panel.

### **SCPI.CALCulate.SP(1-1).TRACe(1-1).LIMit.REPort.DATA**

<variant> = SCPI.CALCulate.SP(1-1).TRACe(1-1).LIMit.REPort.DATA

Description Reads the limit test results of all measurement points in selected traces (Query Only)

Equivalent key No equivalent key is available on the front panel.

### **SCPI.CALCulate.SP(1-1).TRACe(1-1).LIMit.STATe**

Syntax SCPI.CALCulate.SP(1-1).TRACe(1-1).LIMit.STATe = <boolean>

<boolean> = SCPI.CALCulate.SP(1-1).TRACe(1-1).LIMit.STATe

Description Turns on/off the limit test function

Variable

	Param
True or -1	Turn on the limit test function mode
False or 0(Preset value)	Turn off the limit test function mode

Equivalent key SP Menu -> Display -> Limit Test -> Limit Test

**SCPI.CALCulate.SP(1-1).TRACe(1-1).LIMit.UPPer.LDATA**

Syntax SCPI.CALCulate.SP(1-1).TRACe(1-1).LIMit.UPPer.LDATA = <variant>  
 <variant> = SCPI.CALCulate.SP(1-1).TRACe(1-1).LIMit.UPPer.LDATA

Description Sets/reads the upper limit values of all measurement points

Variable

	<Variant>
Range	1...1024
Preset value	-
Unit	-
Resolution	-

Equivalent key No equivalent key is available on the front panel.

**SCPI.CALCulate.SP(1-1).TRACe(1-1).LIMit.UPPer.SEGMent.CLEAr**

Syntax SCPI.CALCulate.SP(1-1).TRACe(1-1).LIMit.UPPer.SEGMent.CLEAr

Description Clears the upper limit line (No Query)

Equivalent key SP Menu -> Display -> Limit Test -> Delete Upper Limit Line

**SCPI.CALCulate.SP(1-1).TRACe(1-1).LIMit.UPPer.SEGMent.COUNT**

Syntax SCPI.CALCulate.SP(1-1).TRACe(1-1).LIMit.UPPer.SEGMent.COUNT = <long>  
 <long> = SCPI.CALCulate.SP(1-1).TRACe(1-1).LIMit.UPPer.SEGMent.COUNT

Description Sets/reads the number of segments in the upper limit line

Variable

	<Long>
Range	1 to 100
Preset value	1
Unit	-
Resolution	-

Equivalent key No equivalent key is available on the front panel.

**SCPI.CALCulate.SP(1-1).TRACe(1-1).LIMit.UPPer.SEGMent.DATA**

Syntax SCPI.CALCulate.SP(1-1).TRACe(1-1).LIMit.UPPer.SEGMent.DATA = <variant>  
 <variant> = SCPI.CALCulate.SP(1-1).TRACe(1-1).LIMit.UPPer.SEGMent.DATA

Description Sets/reads segment data of the upper limit line

Variable

	<Variant>
Range	1...400
Preset value	-
Unit	-
Resolution	-

Equivalent key No equivalent key is available on the front panel.

**SCPI.CALCulate.SP(1-1).TRACe(1-1).MARKer(1-6).SEARch.EXECute.LPEak**

Syntax SCPI.CALCulate.SP(1-1).TRACe(1-1).MARKer(1-6).SEARch.EXECute.LPEak

Description Execute marker peak search left (No Read)

Equivalent key SP Menu -> Marker Search -> Peak -> Search Left

**SCPI.CALCulate.SP(1-1).TRACe(1-1).MARKer(1-6).SEARch.EXECute.LTARget**

Syntax SCPI.CALCulate.SP(1-1).TRACe(1-1).MARKer(1-6).SEARch.EXECute.LTARget

Description Execute marker target search left (No Read)



**SCPI.CALCulate.SP(1-1).TRACe(1-1).MARKer(1-6).SEARch.EXECute.MAXimum**

Equivalent key SP Menu -> Marker Search -> Target -> Search Left

**SCPI.CALCulate.SP(1-1).TRACe(1-1).MARKer(1-6).SEARch.EXECute.MAXimum**

Syntax SCPI.CALCulate.SP(1-1).TRACe(1-1).MARKer(1-6).SEARch.EXECute.MAXimum

Description Execute marker search maximum (No Read)

Equivalent key SP Menu -> Marker Search -> Search Max

**SCPI.CALCulate.SP(1-1).TRACe(1-1).MARKer(1-6).SEARch.EXECute.MINimum**

Syntax SCPI.CALCulate.SP(1-1).TRACe(1-1).MARKer(1-6).SEARch.EXECute.MINimum

Description Execute marker search minimum (No Read)

Equivalent key SP Menu -> Marker Search -> Search Min

**SCPI.CALCulate.SP(1-1).TRACe(1-1).MARKer(1-6).SEARch.EXECute.PEAK**

Syntax SCPI.CALCulate.SP(1-1).TRACe(1-1).MARKer(1-6).SEARch.EXECute.PEAK

Description execute marker peak search (No Read)

Equivalent key SP Menu -> Marker Search -> Peak -> Search Peak

**SCPI.CALCulate.SP(1-1).TRACe(1-1).MARKer(1-6).SEARch.EXECute.RPEak**

Syntax SCPI.CALCulate.SP(1-1).TRACe(1-1).MARKer(1-6).SEARch.EXECute.RPEak

Description Execute marker peak search right (No Read)

Equivalent key SP Menu -> Marker Search -> Peak -> Search Right

**SCPI.CALCulate.SP(1-1).TRACe(1-1).MARKer(1-6).SEARch.EXECute.RTARget**

Syntax SCPI.CALCulate.SP(1-1).TRACe(1-1).MARKer(1-6).SEARch.EXECute.RTARget

Description Execute marker target search right (No Read)

Equivalent key SP Menu -> Marker Search -> Target -> Search Right

**SCPI.CALCulate.SP(1-1).TRACe(1-1).MARKer(1-6).SEARch.EXECute.TARGET**

Syntax SCPI.CALCulate.SP(1-1).TRACe(1-1).MARKer(1-6).SEARch.EXECute.TARGET

Description Execute marker target search (No Read)

Equivalent key SP Menu -> Marker Search -> Target -> Search Target

**SCPI.CALCulate.SP(1-1).TRACe(1-1).MARKer(1-6).SEARch.PEAK.EXCursion**

Syntax SCPI.CALCulate.SP(1-1).TRACe(1-1).MARKer(1-6).SEARch.PEAK.EXCursion =  
<double>

<double> =

SCPI.CALCulate.SP(1-1).TRACe(1-1).MARKer(1-6).SEARch.PEAK.EXCursion

Description Sets/reads the peak excursion value

Variable

	<b>&lt;Double&gt;</b>
Range	0 to 10G
Preset value	0
Unit	-
Resolution	-

Equivalent key SP Menu -> Marker Search -> Peak -> Peak Excursion

**SCPI.CALCulate.SP(1-1).TRACe(1-1).MARKer(1-6).SEARch.PEAK.POLarity**

Syntax SCPI.CALCulate.SP(1-1).TRACe(1-1).MARKer(1-6).SEARch.PEAK.POLarity =  
<string>

<string> =

SCPI.CALCulate.SP(1-1).TRACe(1-1).MARKer(1-6).SEARch.PEAK.POLarity

Description Sets/reads the marker peak-search polarity

Variable

	<b>Param</b>
POSitive(Preset value)	Set the marker peak-search polarity to 'POSitive'

	Param
NEGative	Set the marker peak-search polarity to 'NEGative'
BOTH	Set the marker peak-search polarity to 'BOTH'

Equivalent key SP Menu -> Marker Search -> Peak -> Peak Polarity

### SCPI.CALCulate.SP(1-1).TRACe(1-1).MARKer(1-6).SEARch.TARGET.TRANSition

Syntax SCPI.CALCulate.SP(1-1).TRACe(1-1).MARKer(1-6).SEARch.TARGET.TRANSition = <string>  
<string> = SCPI.CALCulate.SP(1-1).TRACe(1-1).MARKer(1-6).SEARch.TARGET.TRANSition

Description Sets/reads the target transition definition

Variable

	Param
POSitive	Set the target transition definition to 'POSitive'
NEGative	Set the target transition definition to 'NEGative'
BOTH(Preset value)	Set the target transition definition to 'BOTH'

Equivalent key SP Menu -> Marker Search -> Target -> Target Transition

### SCPI.CALCulate.SP(1-1).TRACe(1-1).MARKer(1-6).SEARch.TARGET.Y

Syntax SCPI.CALCulate.SP(1-1).TRACe(1-1).MARKer(1-6).SEARch.TARGET.Y = <double>  
<double> = SCPI.CALCulate.SP(1-1).TRACe(1-1).MARKer(1-6).SEARch.TARGET.Y

Description Sets/reads the marker target value

Variable

	<Double>
Range	-10G to 10G
Preset value	0
Unit	-
Resolution	-

Equivalent key SP Menu -> Marker Search -> Target -> Target Value

### **SCPI.CALCulate.SP(1-1).TRACe(1-1).MARKer(1-6).SEARch.TRACking.TYPE**

Syntax SCPI.CALCulate.SP(1-1).TRACe(1-1).MARKer(1-6).SEARch.TRACking.TYPE = <string>  
<string> = SCPI.CALCulate.SP(1-1).TRACe(1-1).MARKer(1-6).SEARch.TRACking.TYPE

Description Sets/reads the marker tracking type

Variable

	<b>Param</b>
OFF(Preset value)	Set the marker tracking type to 'OFF'
MAXimum	Set the marker tracking type to 'MAXimum'
MINimum	Set the marker tracking type to 'MINimum'
PEAK	Set the marker tracking type to 'PEAK'
TARGet	Set the marker tracking type to 'TARGet'

Equivalent key SP Menu -> Marker Search -> Tracking

### **SCPI.CALCulate.SP(1-1).TRACe(1-1).MARKer(1-6).STATe**

Syntax SCPI.CALCulate.SP(1-1).TRACe(1-1).MARKer(1-6).STATe = <boolean>  
<boolean> = SCPI.CALCulate.SP(1-1).TRACe(1-1).MARKer(1-6).STATe

Description Turns on/off a marker

Variable

	<b>Param</b>
True or -1	Enable a marker
False or 0(Preset value)	Disable a marker

Equivalent key SP Menu -> Marker -> Clear Marker Menu -> Marker 1

### **SCPI.CALCulate.SP(1-1).TRACe(1-1).MARKer(1-6).X**

Syntax SCPI.CALCulate.SP(1-1).TRACe(1-1).MARKer(1-6).X = <double>  
<double> = SCPI.CALCulate.SP(1-1).TRACe(1-1).MARKer(1-6).X

Description Sets/reads the marker X value

Variable

	<Double>
Range	-
Preset value	992.5M
Unit	-
Resolution	-

Equivalent key No equivalent key is available on the front panel.

**SCPI.CALCulate.SP(1-1).TRACe(1-1).MARKer(1-6).Y**

Syntax <double> = SCPI.CALCulate.SP(1-1).TRACe(1-1).MARKer(1-6).Y

Description Reads the marker Y value (Read Only)

Equivalent key No equivalent key is available on the front panel.

**SCPI.CALCulate.SP(1-1).TRACe(1-1).MATH.FUNCtion**

Syntax SCPI.CALCulate.SP(1-1).TRACe(1-1).MATH.FUNCtion = <string>  
 <string> = SCPI.CALCulate.SP(1-1).TRACe(1-1).MATH.FUNCtion

Description Selects math operation type

Variable

	Param
NORMal(Preset value)	Set math operation type to 'NORMal'
SUBTract	Set math operation type to 'SUBTract'
DIVide	Set math operation type to 'DIVide'
ADD	Set math operation type to 'ADD'
MULTiply	Set math operation type to 'MULTiply'

Equivalent key SP Menu -> Trace View -> Data Math

**SCPI.CALCulate.SP(1-1).TRACe(1-1).MATH.MEMorize**

Syntax SCPI.CALCulate.SP(1-1).TRACe(1-1).MATH.MEMorize

Description Copy data to memory (No Read)

Equivalent key No equivalent key is available on the front panel.

**SCPI.CALCulate.SP(1-1).TRACe(1-1).SMOothing.APERture**

Syntax SCPI.CALCulate.SP(1-1).TRACe(1-1).SMOothing.APERture = <double>  
 <double> = SCPI.CALCulate.SP(1-1).TRACe(1-1).SMOothing.APERture

Description Sets/reads smoothing aperture value

Variable

	<b>&lt;Double&gt;</b>
Range	50m to 25
Preset value	1.5
Unit	%
Resolution	10m

Equivalent key SP Menu -> Trace View -> Aperture

**SCPI.CALCulate.SP(1-1).TRACe(1-1).SMOothing.STATe**

Syntax SCPI.CALCulate.SP(1-1).TRACe(1-1).SMOothing.STATe = <boolean>  
 <boolean> = SCPI.CALCulate.SP(1-1).TRACe(1-1).SMOothing.STATe

Description Turns on/off smoothing function

Variable

	<b>Param</b>
True or -1	Set smoothing function to 'ON'
False or 0(Preset value)	Set smoothing function to 'OFF'

Equivalent key SP Menu -> Trace View -> Smoothing

**SCPI.CALCulate.TR(1-1).ALLTrace.ACTive**

Syntax SCPI.CALCulate.TR(1-1).ALLTrace.ACTive = <long>  
 <long> = SCPI.CALCulate.TR(1-1).ALLTrace.ACTive

Description Selects active trace

Variable

	<Long>
Range	1 to 4
Preset value	1
Unit	-
Resolution	-

Equivalent key No equivalent key is available on the front panel.

**SCPI.CALCulate.TR(1-1).ALLTrace.BDMarker.X.COUPle.STATe**

Syntax SCPI.CALCulate.TR(1-1).ALLTrace.BDMarker.X.COUPle.STATe = <boolean>  
 <boolean> = SCPI.CALCulate.TR(1-1).ALLTrace.BDMarker.X.COUPle.STATe

Description Turns on/off bandmarker coupling function

Variable

	Param
True or -1	Set bandmarker coupling function to 'ON'
False or 0(Preset value)	Set bandmarker coupling function to 'OFF'

Equivalent key TR Menu -> Marker Function -> Couple  
 TR Menu -> Marker Search -> Couple

**SCPI.CALCulate.TR(1-1).ALLTrace.LIMit.FAIL**

<boolean> = SCPI.CALCulate.TR(1-1).ALLTrace.LIMit.FAIL

Description Reads out the limit test result (Query Only)

Variable

	Param
True or -1	The limit test result is fail
False or 0(Preset value)	The limit test result is pass

When the limit test is set to OFF, false or 0 is always read out.

Equivalent key No equivalent key is available on the front panel.

## **SCPI.CALCulate.TR(1-1).ALLTrace.MARKer.COUPle.STATe**

Syntax SCPI.CALCulate.TR(1-1).ALLTrace.MARKer.COUPle.STATe = <boolean>  
<boolean> = SCPI.CALCulate.TR(1-1).ALLTrace.MARKer.COUPle.STATe

Description Turns on/off marker coupling function

Variable

	<b>Param</b>
True or -1	Set marker coupling function to 'ON'
False or 0(Preset value)	Set marker coupling function to 'OFF'

Equivalent key TR Menu -> Marker -> Couple

## **SCPI.CALCulate.TR(1-1).ALLTrace.MARKer.DISCrete.STATe**

Syntax SCPI.CALCulate.TR(1-1).ALLTrace.MARKer.DISCrete.STATe = <boolean>  
<boolean> = SCPI.CALCulate.TR(1-1).ALLTrace.MARKer.DISCrete.STATe

Description Enable/disable marker discrete function

Variable

	<b>Param</b>
True or -1	Enable marker discrete function
False or 0(Preset value)	Disable marker discrete function

Equivalent key TR Menu -> Marker -> More Functions -> Discrete

## **SCPI.CALCulate.TR(1-1).ALLTrace.MARKer.REFerence.NUMBer**

Syntax SCPI.CALCulate.TR(1-1).ALLTrace.MARKer.REFerence.NUMBer = <long>  
<long> = SCPI.CALCulate.TR(1-1).ALLTrace.MARKer.REFerence.NUMBer

Description Sets/reads marker reference number



Variable

	<Long>
Range	1 to 6
Preset value	1
Unit	-
Resolution	-

Equivalent key TR Menu -> Marker -> More Functions -> Ref Marker

**SCPI.CALCulate.TR(1-1).ALLTrace.MARKer.REFerence.S  
TATe**

Syntax SCPI.CALCulate.TR(1-1).ALLTrace.MARKer.REFerence.STATe = <boolean>  
 <boolean> = SCPI.CALCulate.TR(1-1).ALLTrace.MARKer.REFerence.STATe

Description Turns on/off delta marker mode

Variable

	Param
True or -1	Set delta marker mode to 'ON'
False or 0(Preset value)	Set delta marker mode to 'OFF'

Equivalent key TR Menu -> Marker -> More Functions -> Ref Marker Mode

**SCPI.CALCulate.TR(1-1).NARRow.DATA.RDATa**

Syntax SCPI.CALCulate.TR(1-1).NARRow.DATA.RDATa = <variant>  
 <variant> = SCPI.CALCulate.TR(1-1).NARRow.DATA.RDATa

Description Sets/reads the measurement raw data

Variable

	<Variant>
Range	1...3753
Preset value	-
Unit	-
Resolution	-

Equivalent key No equivalent key is available on the front panel.

**SCPI.CALCulate.TR(1-1).NARRow.DATA.XDATA**

Syntax <variant> = SCPI.CALCulate.TR(1-1).NARRow.DATA.XDATA

Description X axis data (Read Only)

Equivalent key No equivalent key is available on the front panel.

**SCPI.CALCulate.TR(1-1).TRACe(1-4).ALLMarker.ACTive**

Syntax SCPI.CALCulate.TR(1-1).TRACe(1-4).ALLMarker.ACTive = <long>

<long> = SCPI.CALCulate.TR(1-1).TRACe(1-4).ALLMarker.ACTive

Description Selects active marker

Variable

	<b>&lt;Long&gt;</b>
Range	1 to 6
Preset value	1
Unit	-
Resolution	-

Equivalent key No equivalent key is available on the front panel.

**SCPI.CALCulate.TR(1-1).TRACe(1-4).ALLMarker.SEARCh.DOMain.X**

Syntax SCPI.CALCulate.TR(1-1).TRACe(1-4).ALLMarker.SEARCh.DOMain.X = <string>

<string> = SCPI.CALCulate.TR(1-1).TRACe(1-4).ALLMarker.SEARCh.DOMain.X

Description Sets/reads marker search range (X-axis)

Variable

	<b>Param</b>
FRANge(Preset value)	Set marker search range (X-axis) to 'FRANge' (full range)
BDMarker	Set marker search range (X-axis) to 'BDMarker' (specified range by bandmarker X)

Equivalent key TR Menu -> Marker Search -> Search Range (X)

**SCPI.CALCulate.TR(1-1).TRACe(1-4).ALLMarker.SEARCh.DOMain.Y**

**Syntax** SCPI.CALCulate.TR(1-1).TRACe(1-4).ALLMarker.SEARCh.DOMain.Y = <string>  
<string> = SCPI.CALCulate.TR(1-1).TRACe(1-4).ALLMarker.SEARCh.DOMain.Y

**Description** Sets/reads marker search range (Y-axis)

**Variable**

	<b>Param</b>
FRANge(Preset value)	Set marker search range (Y-axis) to 'FRANge' (full range)
BDMarker	Set marker search range (Y-axis) to 'BDMarker' (specified range by bandmarker Y)

**Equivalent key** TR Menu -> Marker Search -> Search Range (Y)

**SCPI.CALCulate.TR(1-1).TRACe(1-4).ALLMarker.SEARCh.PEAK**

**Syntax** SCPI.CALCulate.TR(1-1).TRACe(1-4).ALLMarker.SEARCh.PEAK

**Description** Execute marker search all (No Read)

**Equivalent key** TR Menu -> Marker Search -> Peak -> Search Peak All

**SCPI.CALCulate.TR(1-1).TRACe(1-4).BDMarker.X.CENTer**

**Syntax** SCPI.CALCulate.TR(1-1).TRACe(1-4).BDMarker.X.CENTer = <double>  
<double> = SCPI.CALCulate.TR(1-1).TRACe(1-4).BDMarker.X.CENTer

**Description** Sets/reads the center value of bandmarker X

**Variable**

	<b>&lt;Double&gt;</b>
Range	-1T to 1T
Preset value	0
Unit	-
Resolution	-

**Equivalent key** TR Menu -> Marker Function -> Band Marker X -> Center

TR Menu -&gt; Marker Search -&gt; Band Marker X -&gt; Center

**SCPI.CALCulate.TR(1-1).TRACe(1-4).BDMarker.X.SPAN**

## Syntax

SCPI.CALCulate.TR(1-1).TRACe(1-4).BDMarker.X.SPAN = &lt;double&gt;

&lt;double&gt; = SCPI.CALCulate.TR(1-1).TRACe(1-4).BDMarker.X.SPAN

## Description

Sets/reads the span value of bandmarker X

## Variable

	<Double>
Range	0 to 2T
Preset value	2T
Unit	-
Resolution	-

## Equivalent key

TR Menu -&gt; Marker Function -&gt; Band Marker X -&gt; Span

TR Menu -&gt; Marker Search -&gt; Band Marker X -&gt; Span

**SCPI.CALCulate.TR(1-1).TRACe(1-4).BDMarker.X.START**

## Syntax

SCPI.CALCulate.TR(1-1).TRACe(1-4).BDMarker.X.START = &lt;double&gt;

&lt;double&gt; = SCPI.CALCulate.TR(1-1).TRACe(1-4).BDMarker.X.START

## Description

Sets/reads the start value of bandmarker X

## Variable

	<Double>
Range	-1T to 1T
Preset value	-1T
Unit	-
Resolution	-

## Equivalent key

TR Menu -&gt; Marker Function -&gt; Band Marker X -&gt; Start

TR Menu -&gt; Marker Search -&gt; Band Marker X -&gt; Start

**SCPI.CALCulate.TR(1-1).TRACe(1-4).BDMarker.X.STATe**

## Syntax

SCPI.CALCulate.TR(1-1).TRACe(1-4).BDMarker.X.STATe = &lt;boolean&gt;

&lt;boolean&gt; = SCPI.CALCulate.TR(1-1).TRACe(1-4).BDMarker.X.STATe

Description Turn on/off bandmarker X

Variable

	Param
True or -1	Set bandmarker X function to 'ON'
False or 0(Preset value)	Set bandmarker X function to 'OFF'

Equivalent key TR Menu -> Marker Function -> Band Marker X -> Band Marker X  
 TR Menu -> Marker Search -> Band Marker X -> Band Marker X

**SCPI.CALCulate.TR(1-1).TRACe(1-4).BDMarker.X.STOP**

Syntax SCPI.CALCulate.TR(1-1).TRACe(1-4).BDMarker.X.STOP = <double>  
 <double> = SCPI.CALCulate.TR(1-1).TRACe(1-4).BDMarker.X.STOP

Description Sets/reads the stop value of bandmarker X

Variable

	<Double>
Range	-1T to 1T
Preset value	1T
Unit	-
Resolution	-

Equivalent key TR Menu -> Marker Function -> Band Marker X -> Stop  
 TR Menu -> Marker Search -> Band Marker X -> Stop

**SCPI.CALCulate.TR(1-1).TRACe(1-4).BDMarker.Y.CENTe  
 r**

Syntax SCPI.CALCulate.TR(1-1).TRACe(1-4).BDMarker.Y.CENTer = <double>  
 <double> = SCPI.CALCulate.TR(1-1).TRACe(1-4).BDMarker.Y.CENTer

Description Sets/reads the center value of bandmarker Y

Variable

	<Double>
Range	-1T to 1T

	<b>&lt;Double&gt;</b>
Preset value	0
Unit	-
Resolution	-

Equivalent key TR Menu -> Marker Function -> Band Marker Y -> Center

TR Menu -> Marker Search -> Band Marker Y -> Center

### **SCPI.CALCulate.TR(1-1).TRACe(1-4).BDMarker.Y.SPAN**

Syntax SCPI.CALCulate.TR(1-1).TRACe(1-4).BDMarker.Y.SPAN = <double>

<double> = SCPI.CALCulate.TR(1-1).TRACe(1-4).BDMarker.Y.SPAN

Description Sets/reads the span value of bandmarker Y

Variable

	<b>&lt;Double&gt;</b>
Range	0 to 2T
Preset value	2T
Unit	-
Resolution	-

Equivalent key TR Menu -> Marker Function -> Band Marker Y -> Span

TR Menu -> Marker Search -> Band Marker Y -> Span

### **SCPI.CALCulate.TR(1-1).TRACe(1-4).BDMarker.Y.START**

Syntax SCPI.CALCulate.TR(1-1).TRACe(1-4).BDMarker.Y.START = <double>

<double> = SCPI.CALCulate.TR(1-1).TRACe(1-4).BDMarker.Y.START

Description Sets/reads the start value of bandmarker Y

Variable

	<b>&lt;Double&gt;</b>
Range	-IT to IT
Preset value	-IT
Unit	-
Resolution	-

Equivalent key TR Menu -> Marker Function -> Band Marker Y -> Start  
 TR Menu -> Marker Search -> Band Marker Y -> Start

### SCPI.CALCulate.TR(1-1).TRACe(1-4).BDMarker.Y.STATe

Syntax SCPI.CALCulate.TR(1-1).TRACe(1-4).BDMarker.Y.STATe = <boolean>  
 <boolean> = SCPI.CALCulate.TR(1-1).TRACe(1-4).BDMarker.Y.STATe

Description Turn on/off bandmarker Y

Variable

	Param
True or -1	Set bandmarker Y function to 'ON'
False or 0(Preset value)	Set bandmarker Y function to 'OFF'

Equivalent key TR Menu -> Marker Function -> Band Marker Y -> Band Marker Y  
 TR Menu -> Marker Search -> Band Marker Y -> Band Marker Y

### SCPI.CALCulate.TR(1-1).TRACe(1-4).BDMarker.Y.STOP

Syntax SCPI.CALCulate.TR(1-1).TRACe(1-4).BDMarker.Y.STOP = <double>  
 <double> = SCPI.CALCulate.TR(1-1).TRACe(1-4).BDMarker.Y.STOP

Description Sets/reads the stop value of bandmarker Y

Variable

	<Double>
Range	-1T to 1T
Preset value	1T
Unit	-
Resolution	-

Equivalent key TR Menu -> Marker Function -> Band Marker Y -> Stop  
 TR Menu -> Marker Search -> Band Marker Y -> Stop

### SCPI.CALCulate.TR(1-1).TRACe(1-4).DATA.COPY

Syntax SCPI.CALCulate.TR(1-1).TRACe(1-4).DATA.COPY

Description Copies trace data to the user trace (No Query)

COM Object Reference  
**SCPI.CALCulate.TR(1-1).TRACe(1-4).DATA.FDATa**

Variable

	<b>&lt;Long&gt;</b>
Range	1 to 8
Preset value	-
Unit	-
Resolution	-

Equivalent key

TR Menu -> Trace View-> Copy to USER -> Copy to USER1  
 TR Menu -> Trace View-> Copy to USER -> Copy to USER2  
 TR Menu -> Trace View-> Copy to USER -> Copy to USER3  
 TR Menu -> Trace View-> Copy to USER -> Copy to USER4  
 TR Menu -> Trace View-> Copy to USER -> Copy to USER5  
 TR Menu -> Trace View-> Copy to USER -> Copy to USER6  
 TR Menu -> Trace View-> Copy to USER -> Copy to USER7  
 TR Menu -> Trace View-> Copy to USER -> Copy to USER8

**SCPI.CALCulate.TR(1-1).TRACe(1-4).DATA.FDATa**

Syntax

SCPI.CALCulate.TR(1-1).TRACe(1-4).DATA.FDATa = <variant>  
 <variant> = SCPI.CALCulate.TR(1-1).TRACe(1-4).DATA.FDATa

Description

Sets/reads formatted trace data

Variable

	<b>&lt;Variant&gt;</b>
Range	1...1001
Preset value	-
Unit	-
Resolution	-

Equivalent key

No equivalent key is available on the front panel.

**SCPI.CALCulate.TR(1-1).TRACe(1-4).DATA.FMEMory**

Syntax

SCPI.CALCulate.TR(1-1).TRACe(1-4).DATA.FMEMory = <variant>  
 <variant> = SCPI.CALCulate.TR(1-1).TRACe(1-4).DATA.FMEMory

Description

Sets/reads formatted memory data



Variable

	<Variant>
Range	1...1001
Preset value	-
Unit	-
Resolution	-

Equivalent key No equivalent key is available on the front panel.

**SCPI.CALCulate.TR(1-1).TRACe(1-4).DATA.UDATa**

Syntax SCPI.CALCulate.TR(1-1).TRACe(1-4).DATA.UDATa = <variant>  
 <variant> = SCPI.CALCulate.TR(1-1).TRACe(1-4).DATA.UDATa

Description Sets/reads unformatted trace data

Variable

	<Variant>
Range	1...1001
Preset value	-
Unit	-
Resolution	-

Equivalent key No equivalent key is available on the front panel.

**SCPI.CALCulate.TR(1-1).TRACe(1-4).DATA.UMEMory**

Syntax SCPI.CALCulate.TR(1-1).TRACe(1-4).DATA.UMEMory = <variant>  
 <variant> = SCPI.CALCulate.TR(1-1).TRACe(1-4).DATA.UMEMory

Description Sets/reads unformatted memory data

Variable

	<Variant>
Range	1...1001
Preset value	-
Unit	-

COM Object Reference  
**SCPI.CALCulate.TR(1-1).TRACe(1-4).FORMat.FREQuency**

	<b>&lt;Variant&gt;</b>
Resolution	-

Equivalent key No equivalent key is available on the front panel.

**SCPI.CALCulate.TR(1-1).TRACe(1-4).FORMat.FREQuency**

Syntax SCPI.CALCulate.TR(1-1).TRACe(1-4).FORMat.FREQuency = <string>  
 <string> = SCPI.CALCulate.TR(1-1).TRACe(1-4).FORMat.FREQuency

Description Sets/reads the frequency format

Variable

	<b>Param</b>
HZ(Preset value)	Set the frequency format to 'Hz'
DHZ	Se the frequency format to 'ΔHZ'
PCT	Set the frequency format to '%'
PPM	Set the frequency format to 'ppm'

Equivalent key TR Menu -> Format -> Frequency Format

**SCPI.CALCulate.TR(1-1).TRACe(1-4).FORMat.PHASE.PREFeRence.OFFSet**

Syntax SCPI.CALCulate.TR(1-1).TRACe(1-4).FORMat.PHASE.PREFeRence.OFFSet = <double>  
 <double> = SCPI.CALCulate.TR(1-1).TRACe(1-4).FORMat.PHASE.PREFeRence.OFFSet

Description Sets/reads the offset value of the phase reference frequency

Variable

	<b>&lt;Double&gt;</b>
Range	-25.6M to 25.6M
Preset value	0
Unit	Hz
Resolution	1m

Equivalent key TR Menu -> Setup -> Recalc Phase Reference -> Phase Ref. Offset

## SCPI.CALCulate.TR(1-1).TRACe(1-4).FORMat.PHASE.UNIT

Syntax SCPI.CALCulate.TR(1-1).TRACe(1-4).FORMat.PHASE.UNIT = <string>

<string> = SCPI.CALCulate.TR(1-1).TRACe(1-4).FORMat.PHASE.UNIT

Description Selects phase format on transient measurement

Variable

	Param
DEG(Preset value)	Set phase format on transient measurement to 'DEG' (degree)
RAD	Set phase format on transient measurement to 'RAD' (radian)
GRAD	Set phase format on transient measurement to 'GRAD' (gradian)

Equivalent key TR Menu -> Format -> Phase Unit

## SCPI.CALCulate.TR(1-1).TRACe(1-4).FORMat.PHASE.WRAP

Syntax SCPI.CALCulate.TR(1-1).TRACe(1-4).FORMat.PHASE.WRAP = <boolean>

<boolean> = SCPI.CALCulate.TR(1-1).TRACe(1-4).FORMat.PHASE.WRAP

Description Turns on/off wrap-phase

Variable

	Param
True or -1(Preset value)	Set wrap-phase mode to 'ON'
False or 0	Set wrap-phase mode to 'OFF'

Equivalent key TR Menu -> Format -> Wrap Phase

## SCPI.CALCulate.TR(1-1).TRACe(1-4).FUNCTion.DOMain.X

Syntax SCPI.CALCulate.TR(1-1).TRACe(1-4).FUNCTion.DOMain.X = <string>

<string> = SCPI.CALCulate.TR(1-1).TRACe(1-4).FUNCTion.DOMain.X

Description Sets/reads analysis/search range (X-axis)

Variable

	<b>Param</b>
FRANge	Set analysis/search range (X-axis) to 'FRANge' (full range)
BDMarker(Preset value)	Set analysis/search range (X-axis) to 'BDMarker' (specified range by bandmarker X)

Equivalent key TR Menu -> Marker Function -> Analysis Range (X)

## **SCPI.CALCulate.TR(1-1).TRACe(1-4).FUNction.DOMain.Y**

Syntax SCPI.CALCulate.TR(1-1).TRACe(1-4).FUNction.DOMain.Y = <string>  
 <string> = SCPI.CALCulate.TR(1-1).TRACe(1-4).FUNction.DOMain.Y

Description Sets/reads analysis/search range (Y-axis)

Variable

	<b>Param</b>
FRANge	Set analysis/search range (Y-axis) to 'FRANge' (full range)
BDMarker(Preset value)	Set analysis/search range (Y-axis) to 'BDMarker' (specified range by bandmarker Y)

Equivalent key TR Menu -> Marker Function -> Analysis Range (Y)

## **SCPI.CALCulate.TR(1-1).TRACe(1-4).FUNction.STATistics.DATA\_Q**

Syntax SCPI.CALCulate.TR(1-1).TRACe(1-4).FUNction.STATistics.DATA\_Q mean, std\_dev, peak\_to\_peak

Description Reads the result of statistical analysis for the data trace (Read Only)

Examples  

```
Dim meas As Double
Dim s_dev As Double
Dim p_p As Double

SCPI.CALCulate.TR.TRACe.FUNction.STATistics.DATA_Q mean, s_dev, p_p
```

Equivalent key No equivalent key is available on the front panel.

## **SCPI.CALCulate.TR(1-1).TRACe(1-4).FUNction.STATistics.MEMory\_Q**

Syntax SCPI.CALCulate.TR(1-1).TRACe(1-4).FUNction.STATistics.MEMory\_Q mean, std\_dev,

peak\_to\_peak

**Description** Reads the result of statistical analysis for the memory trace (Read Only)

**Examples**

```
Dim meas As Double
Dim s_dev As Double
Dim p_p As Double

SCPI.CALCulate.TR.TRACe.FUNCTion.STATistics.MEMory_Q mean, s_dev,
p_p
```

**Equivalent key** No equivalent key is available on the front panel.

**SCPI.CALCulate.TR(1-1).TRACe(1-4).FUNCTion.TYPE**

**Syntax** SCPI.CALCulate.TR(1-1).TRACe(1-4).FUNCTion.TYPE = <string>  
 <string> = SCPI.CALCulate.TR(1-1).TRACe(1-4).FUNCTion.TYPE

**Description** Sets/reads analysis type

**Variable**

	<b>Param</b>
OFF(Preset value)	Set analysis type to 'OFF'
STATistics	Set analysis type to 'STATistics'

**Equivalent key** TR Menu -> Marker Function -> Analysis Type

**SCPI.CALCulate.TR(1-1).TRACe(1-4).HOLD**

**Syntax** SCPI.CALCulate.TR(1-1).TRACe(1-4).HOLD = <string>  
 <string> = SCPI.CALCulate.TR(1-1).TRACe(1-4).HOLD

**Description** Sets/reads data hold type

**Variable**

	<b>Param</b>
OFF(Preset value)	Set data hold type to 'OFF'
MAXimum	Set data hold type to 'MAXimum'
MINimum	Set data hold type to 'MINimum'

**Equivalent key** TR Menu -> Trace View -> Data Hold

## **SCPI.CALCulate.TR(1-1).TRACe(1-4).LIMit.FAIL**

<boolean> = SCPI.CALCulate.TR(1-1).TRACe(1-4).LIMit.FAIL

Description Reads out the limit test result (Query Only)

Variable

	<b>Param</b>
True or -1	The limit test result is fail
False or 0(Preset value)	The limit test result is pass

When the limit test is set to OFF, false or 0 is always read out.

Equivalent key No equivalent key is available on the front panel.

## **SCPI.CALCulate.TR(1-1).TRACe(1-4).LIMit.LOWER.LDATa**

Syntax SCPI.CALCulate.TR(1-1).TRACe(1-4).LIMit.LOWER.LDATa = <variant>  
<variant> = SCPI.CALCulate.TR(1-1).TRACe(1-4).LIMit.LOWER.LDATa

Description Sets/reads the lower limit values of all measurement points

Variable

	<b>&lt;Variant&gt;</b>
Range	1...1001
Preset value	-
Unit	-
Resolution	-

Equivalent key No equivalent key is available on the front panel.

## **SCPI.CALCulate.TR(1-1).TRACe(1-4).LIMit.LOWER.SEGMent.CLEAr**

Syntax SCPI.CALCulate.TR(1-1).TRACe(1-4).LIMit.LOWER.SEGMent.CLEAr

Description Clears the lower limit line (No Query)

Equivalent key TR Menu -> Display -> Limit Test -> Delete Lower Limit Line

### **SCPI.CALCulate.TR(1-1).TRACe(1-4).LIMit.LOWer.SEGMent.COUNT**

**Syntax** SCPI.CALCulate.TR(1-1).TRACe(1-4).LIMit.LOWer.SEGMent.COUNT = <long>  
 <long> = SCPI.CALCulate.TR(1-1).TRACe(1-4).LIMit.LOWer.SEGMent.COUNT

**Description** Sets/reads the number of segments in the lower limit line

**Variable**

	<Long>
Range	1 to 100
Preset value	1
Unit	-
Resolution	-

**Equivalent key** No equivalent key is available on the front panel.

### **SCPI.CALCulate.TR(1-1).TRACe(1-4).LIMit.LOWer.SEGMent.DATA**

**Syntax** SCPI.CALCulate.TR(1-1).TRACe(1-4).LIMit.LOWer.SEGMent.DATA = <variant>  
 <variant> = SCPI.CALCulate.TR(1-1).TRACe(1-4).LIMit.LOWer.SEGMent.DATA

**Description** Sets/reads segment data of the lower limit line

**Variable**

	<Variant>
Range	1..400
Preset value	-
Unit	-
Resolution	-

**Equivalent key** No equivalent key is available on the front panel.

### **SCPI.CALCulate.TR(1-1).TRACe(1-4).LIMit.REPport.DAT A**

<variant> = SCPI.CALCulate.TR(1-1).TRACe(1-4).LIMit.REPport.DAT A

**Description** Reads the limit test results of all measurement points in selected traces (Query Only)

Equivalent key No equivalent key is available on the front panel.

**SCPI.CALCulate.TR(1-1).TRACe(1-4).LIMit.STATe**

Syntax SCPI.CALCulate.TR(1-1).TRACe(1-4).LIMit.STATe = <boolean>  
 <boolean> = SCPI.CALCulate.TR(1-1).TRACe(1-4).LIMit.STATe

Description Turns on/off the limit test function

Variable

	Param
True or -1	Turn on the limit test function mode
False or 0(Preset value)	Turn off the limit test function mode

Equivalent key TR Menu -> Display -> Limit Test -> Limit Test

**SCPI.CALCulate.TR(1-1).TRACe(1-4).LIMit.UPPer.LDATA**

Syntax SCPI.CALCulate.TR(1-1).TRACe(1-4).LIMit.UPPer.LDATA = <variant>  
 <variant> = SCPI.CALCulate.TR(1-1).TRACe(1-4).LIMit.UPPer.LDATA

Description Sets/reads the upper limit values of all measurement points

Variable

	<Variant>
Range	1...1001
Preset value	-
Unit	-
Resolution	-

Equivalent key No equivalent key is available on the front panel.

**SCPI.CALCulate.TR(1-1).TRACe(1-4).LIMit.UPPer.SEGMent.CLEAr**

Syntax SCPI.CALCulate.TR(1-1).TRACe(1-4).LIMit.UPPer.SEGMent.CLEAr

Description Clears the upper limit line (No Query)

Equivalent key TR Menu -> Display -> Limit Test -> Delete Upper Limit Line



### **SCPI.CALCulate.TR(1-1).TRACe(1-4).LIMit.UPPer.SEGMent.COUNT**

**Syntax** SCPI.CALCulate.TR(1-1).TRACe(1-4).LIMit.UPPer.SEGMent.COUNT = <long>  
 <long> = SCPI.CALCulate.TR(1-1).TRACe(1-4).LIMit.UPPer.SEGMent.COUNT

**Description** Sets/reads the number of segments in the upper limit line

**Variable**

	<Long>
Range	1 to 100
Preset value	1
Unit	-
Resolution	-

**Equivalent key** No equivalent key is available on the front panel.

### **SCPI.CALCulate.TR(1-1).TRACe(1-4).LIMit.UPPer.SEGMent.DATA**

**Syntax** SCPI.CALCulate.TR(1-1).TRACe(1-4).LIMit.UPPer.SEGMent.DATA = <variant>  
 <variant> = SCPI.CALCulate.TR(1-1).TRACe(1-4).LIMit.UPPer.SEGMent.DATA

**Description** Sets/reads segment data of the upper limit line

**Variable**

	<Variant>
Range	1..400
Preset value	-
Unit	-
Resolution	-

**Equivalent key** No equivalent key is available on the front panel.

### **SCPI.CALCulate.TR(1-1).TRACe(1-4).MARKer(1-6).SEARch.EXECute.LPEak**

**Syntax** SCPI.CALCulate.TR(1-1).TRACe(1-4).MARKer(1-6).SEARch.EXECute.LPEak

**Description** Execute marker peak search left (No Read)

**SCPI.CALCulate.TR(1-1).TRACe(1-4).MARKer(1-6).SEARch.EXECute.LTARget**

Equivalent key TR Menu -> Marker Search -> Peak -> Search Left

**SCPI.CALCulate.TR(1-1).TRACe(1-4).MARKer(1-6).SEARch.EXECute.LTARget**

Syntax SCPI.CALCulate.TR(1-1).TRACe(1-4).MARKer(1-6).SEARch.EXECute.LTARget

Description Execute marker target search left (No Read)

Equivalent key TR Menu -> Marker Search -> Target -> Search Left

**SCPI.CALCulate.TR(1-1).TRACe(1-4).MARKer(1-6).SEARch.EXECute.MAXimum**

Syntax SCPI.CALCulate.TR(1-1).TRACe(1-4).MARKer(1-6).SEARch.EXECute.MAXimum

Description Execute marker search maximum (No Read)

Equivalent key TR Menu -> Marker Search -> Search Max

**SCPI.CALCulate.TR(1-1).TRACe(1-4).MARKer(1-6).SEARch.EXECute.MINimum**

Syntax SCPI.CALCulate.TR(1-1).TRACe(1-4).MARKer(1-6).SEARch.EXECute.MINimum

Description Execute marker search minimum (No Read)

Equivalent key TR Menu -> Marker Search -> Search Min

**SCPI.CALCulate.TR(1-1).TRACe(1-4).MARKer(1-6).SEARch.EXECute.PEAK**

Syntax SCPI.CALCulate.TR(1-1).TRACe(1-4).MARKer(1-6).SEARch.EXECute.PEAK

Description Execute marker peak search (No Read)

Equivalent key TR Menu -> Marker Search -> Peak -> Search Peak

**SCPI.CALCulate.TR(1-1).TRACe(1-4).MARKer(1-6).SEARch.EXECute.RPEak**

Syntax SCPI.CALCulate.TR(1-1).TRACe(1-4).MARKer(1-6).SEARch.EXECute.RPEak

Description Execute marker peak search right (No Read)

Equivalent key TR Menu -> Marker Search -> Peak -> Search Right

Syntax SCPI.CALCulate.TR(1-1).TRACe(1-4).MARKer(1-6).SEARch.EXECute.RTARget

Description Execute marker target search right (No Read)

Equivalent key TR Menu -> Marker Search -> Target -> Search Right

### **SCPI.CALCulate.TR(1-1).TRACe(1-4).MARKer(1-6).SEARch.EXECute.TARGet**

Syntax SCPI.CALCulate.TR(1-1).TRACe(1-4).MARKer(1-6).SEARch.EXECute.TARGet

Description Execute marker target search (No Read)

Equivalent key TR Menu -> Marker Search -> Target -> Search Target

### **SCPI.CALCulate.TR(1-1).TRACe(1-4).MARKer(1-6).SEARch.PEAK.EXCursion**

Syntax SCPI.CALCulate.TR(1-1).TRACe(1-4).MARKer(1-6).SEARch.PEAK.EXCursion =  
<double>

<double> =

SCPI.CALCulate.TR(1-1).TRACe(1-4).MARKer(1-6).SEARch.PEAK.EXCursion

Description Sets/reads the peak excursion value

Variable

	<Double>
Range	0 to 10G
Preset value	0
Unit	-
Resolution	-

Equivalent key TR Menu -> Marker Search -> Peak -> Peak Excursion

### **SCPI.CALCulate.TR(1-1).TRACe(1-4).MARKer(1-6).SEARch.PEAK.POLarity**

Syntax SCPI.CALCulate.TR(1-1).TRACe(1-4).MARKer(1-6).SEARch.PEAK.POLarity =  
<string>

<string> =

SCPI.CALCulate.TR(1-1).TRACe(1-4).MARKer(1-6).SEARch.PEAK.POLarity

**SCPI.CALCulate.TR(1-1).TRACe(1-4).MARKer(1-6).SEARch.TARGet.TRANSition**

Description Sets/reads the marker peak-search polarity

Variable

	<b>Param</b>
POSitive(Preset value)	Set the marker peak-search polarity to 'POSitive'
NEGative	Set the marker peak-search polarity to 'NEGative'
BOTH	Set the marker peak-search polarity to 'BOTH'

Equivalent key TR Menu -> Marker Search -> Peak -> Peak Polarity

**SCPI.CALCulate.TR(1-1).TRACe(1-4).MARKer(1-6).SEARch.TARGet.TRANSition**

Syntax SCPI.CALCulate.TR(1-1).TRACe(1-4).MARKer(1-6).SEARch.TARGet.TRANSition = <string>

<string> =

SCPI.CALCulate.TR(1-1).TRACe(1-4).MARKer(1-6).SEARch.TARGet.TRANSition

Description Sets/reads the target transition definition

Variable

	<b>Param</b>
POSitive	Set the target transition definition to 'POSitive'
NEGative	Set the target transition definition to 'NEGative'
BOTH(Preset value)	Set the target transition definition to 'BOTH'

Equivalent key TR Menu -> Marker Search -> Target -> Target Transition

**SCPI.CALCulate.TR(1-1).TRACe(1-4).MARKer(1-6).SEARch.TARGet.Y**

Syntax SCPI.CALCulate.TR(1-1).TRACe(1-4).MARKer(1-6).SEARch.TARGet.Y = <double>

<double> = SCPI.CALCulate.TR(1-1).TRACe(1-4).MARKer(1-6).SEARch.TARGet.Y

Description Sets/reads the marker target value

Variable

	<Double>
Range	-10G to 10G
Preset value	0
Unit	-
Resolution	-

Equivalent key

TR Menu -&gt; Marker Search -&gt; Target -&gt; Target Value

### SCPI.CALCulate.TR(1-1).TRACe(1-4).MARKer(1-6).SEARch.TRACKing.TYPE

Syntax

SCPI.CALCulate.TR(1-1).TRACe(1-4).MARKer(1-6).SEARch.TRACKing.TYPE = &lt;string&gt;

&lt;string&gt; =

SCPI.CALCulate.TR(1-1).TRACe(1-4).MARKer(1-6).SEARch.TRACKing.TYPE

Description

Sets/reads the marker tracking type

Variable

	Param
OFF(Preset value)	Set the marker tracking type to 'OFF'
MAXimum	Set the marker tracking type to 'MAXimum'
MINimum	Set the marker tracking type to 'MINimum'
PEAK	Set the marker tracking type to 'PEAK'
TARGet	Set the marker tracking type to 'TARGet'

Equivalent key

TR Menu -&gt; Marker Search -&gt; Tracking

### SCPI.CALCulate.TR(1-1).TRACe(1-4).MARKer(1-6).STATe

Syntax

SCPI.CALCulate.TR(1-1).TRACe(1-4).MARKer(1-6).STATe = &lt;boolean&gt;

&lt;boolean&gt; = SCPI.CALCulate.TR(1-1).TRACe(1-4).MARKer(1-6).STATe

Description

Turns on/off a marker

Variable

	<b>Param</b>
True or -1	Enable a marker
False or 0(Preset value)	Disable a marker

Equivalent key TR Menu -> Marker -> Clear Marker Menu -> Marker 1

### **SCPI.CALCulate.TR(1-1).TRACe(1-4).MARKer(1-6).X**

Syntax SCPI.CALCulate.TR(1-1).TRACe(1-4).MARKer(1-6).X = <double>  
<double> = SCPI.CALCulate.TR(1-1).TRACe(1-4).MARKer(1-6).X

Description Sets/reads the marker X value

Variable

	<b>&lt;Double&gt;</b>
Range	-
Preset value	-50m
Unit	-
Resolution	-

Equivalent key No equivalent key is available on the front panel.

### **SCPI.CALCulate.TR(1-1).TRACe(1-4).MARKer(1-6).Y**

Syntax <double> = SCPI.CALCulate.TR(1-1).TRACe(1-4).MARKer(1-6).Y

Description Reads the marker Y value (Read Only)

Equivalent key No equivalent key is available on the front panel.

### **SCPI.CALCulate.TR(1-1).TRACe(1-4).MATH.FUNcTion**

Syntax SCPI.CALCulate.TR(1-1).TRACe(1-4).MATH.FUNcTion = <string>  
<string> = SCPI.CALCulate.TR(1-1).TRACe(1-4).MATH.FUNcTion

Description Selects math operation type

Variable

	Param
NORMal(Preset value)	Set math operation type to 'NORMal'
SUBTract	Set math operation type to 'SUBTract'
DIVide	Set math operation type to 'DIVide'
ADD	Set math operation type to 'ADD'
MULTiply	Set math operation type to 'MULTiply'

Equivalent key TR Menu -> Trace View -> Data Math

**SCPI.CALCulate.TR(1-1).TRACe(1-4).MATH.MEMorize**

Syntax SCPI.CALCulate.TR(1-1).TRACe(1-4).MATH.MEMorize

Description Copy data to memory (No Read)

Equivalent key No equivalent key is available on the front panel.

**SCPI.CALCulate.TR(1-1).TRACe(1-4).PARAmeter**

<string> = SCPI.CALCulate.TR(1-1).TRACe(1-4).PARAmeter

Description Reads the trace parmeter. (Query Only)

Equivalent key No equivalent key is available on the front panel.

**SCPI.CALCulate.TR(1-1).TRACe(1-4).REFerence.FREQue  
ncy**

Syntax SCPI.CALCulate.TR(1-1).TRACe(1-4).REFerence.FREQuency = <double>

<double> = SCPI.CALCulate.TR(1-1).TRACe(1-4).REFerence.FREQuency

Description Sets/reads the reference frequency

Variable

	<Double>
Range	-50G to 50G
Preset value	0
Unit	Hz
Resolution	-

Equivalent key TR Menu -> Format -> Frequency Reference

**SCPI.CALCulate.TR(1-1).TRACe(1-4).SMOothing.APERture**

Syntax SCPI.CALCulate.TR(1-1).TRACe(1-4).SMOothing.APERture = <double>  
 <double> = SCPI.CALCulate.TR(1-1).TRACe(1-4).SMOothing.APERture

Description Sets/reads smoothing aperture value

Variable

	<b>&lt;Double&gt;</b>
Range	50m to 25
Preset value	1.5
Unit	%
Resolution	10m

Equivalent key TR Menu -> Trace View -> Aperture

**SCPI.CALCulate.TR(1-1).TRACe(1-4).SMOothing.STATe**

Syntax SCPI.CALCulate.TR(1-1).TRACe(1-4).SMOothing.STATe = <boolean>  
 <boolean> = SCPI.CALCulate.TR(1-1).TRACe(1-4).SMOothing.STATe

Description Turns on/off smoothing function

Variable

	<b>Param</b>
True or -1	Set smoothing function to 'ON'
False or 0(Preset value)	Set smoothing function to 'OFF'

Equivalent key TR Menu -> Trace View -> Smoothing

**SCPI.CALCulate.TR(1-1).WIDE.DATA.RDATA**

Syntax SCPI.CALCulate.TR(1-1).WIDE.DATA.RDATA = <variant>  
 <variant> = SCPI.CALCulate.TR(1-1).WIDE.DATA.RDATA

Description Sets/reads the measurement raw data



Variable

	<b>&lt;Variant&gt;</b>
Range	1...1001
Preset value	-
Unit	-
Resolution	-

Equivalent key No equivalent key is available on the front panel.

**SCPI.CALCulate.TR(1-1).WIDE.DATA.XDATA**

Syntax <variant> = SCPI.CALCulate.TR(1-1).WIDE.DATA.XDATA

Description Reads the X-axis data (Read Only)

Equivalent key No equivalent key is available on the front panel.

**SCPI.CALCulate.USER(1-1).ALLTrace.ACTive**

Syntax SCPI.CALCulate.USER(1-1).ALLTrace.ACTive = <long>  
 <long> = SCPI.CALCulate.USER(1-1).ALLTrace.ACTive

Description Selects active trace

Variable

	<b>&lt;Long&gt;</b>
Range	1 to 8
Preset value	1
Unit	-
Resolution	-

Equivalent key No equivalent key is available on the front panel.

**SCPI.CALCulate.USER(1-1).ALLTrace.BDMarker.X.COUPle.STATE**

Syntax SCPI.CALCulate.USER(1-1).ALLTrace.BDMarker.X.COUPle.STATE = <boolean>  
 <boolean> = SCPI.CALCulate.USER(1-1).ALLTrace.BDMarker.X.COUPle.STATE

Description Turns on/off bandmarker coupling function

Variable

	<b>Param</b>
True or -1	Set bandmarker coupling function to 'ON'
False or 0(Preset value)	Set bandmarker coupling function to 'OFF'

Equivalent key  
USER Menu -> Marker Function -> Couple  
USER Menu -> Marker Search -> Couple

### **SCPI.CALCulate.USER(1-1).ALLTrace.LIMit.FAIL**

<boolean> = SCPI.CALCulate.USER(1-1).ALLTrace.LIMit.FAIL

Description  
Reads out the limit test result (Query Only)

Variable

	<b>Param</b>
True or -1	The limit test result is fail
False or 0(Preset value)	The limit test result is pass

When the limit test is set to OFF, false or 0 is always read out.

Equivalent key  
No equivalent key is available on the front panel.

### **SCPI.CALCulate.USER(1-1).ALLTrace.MARKer.COUPLE.STATe**

Syntax  
SCPI.CALCulate.USER(1-1).ALLTrace.MARKer.COUPLE.STATe = <boolean>  
<boolean> = SCPI.CALCulate.USER(1-1).ALLTrace.MARKer.COUPLE.STATe

Description  
Turns on/off marker coupling function

Variable

	<b>Param</b>
True or -1	Set marker coupling function to 'ON'
False or 0(Preset value)	Set marker coupling function to 'OFF'

Equivalent key  
USER Menu -> Marker -> Couple

## **SCPI.CALCulate.USER(1-1).ALLTrace.MARKer.DISCrete.STATe**

**Syntax** SCPI.CALCulate.USER(1-1).ALLTrace.MARKer.DISCrete.STATe = <boolean>  
 <boolean> = SCPI.CALCulate.USER(1-1).ALLTrace.MARKer.DISCrete.STATe

**Description** Enables/disables marker discrete function

**Variable**

	<b>Param</b>
True or -1	Enable marker discrete function
False or 0(Preset value)	Disable marker discrete function

**Equivalent key** USER Menu -> Marker -> More Functions -> Discrete

## **SCPI.CALCulate.USER(1-1).ALLTrace.MARKer.REFerence.NUMBer**

**Syntax** SCPI.CALCulate.USER(1-1).ALLTrace.MARKer.REFerence.NUMBer = <long>  
 <long> = SCPI.CALCulate.USER(1-1).ALLTrace.MARKer.REFerence.NUMBer

**Description** Sets/reads marker reference number

**Variable**

	<b>&lt;Long&gt;</b>
Range	1 to 6
Preset value	1
Unit	-
Resolution	-

**Equivalent key** USER Menu -> Marker -> More Functions -> Ref Marker

## **SCPI.CALCulate.USER(1-1).ALLTrace.MARKer.REFerence.STATe**

**Syntax** SCPI.CALCulate.USER(1-1).ALLTrace.MARKer.REFerence.STATe = <boolean>  
 <boolean> = SCPI.CALCulate.USER(1-1).ALLTrace.MARKer.REFerence.STATe

**Description** Turns on/off delta marker mode

Variable

	<b>Param</b>
True or -1	Set delta marker mode to 'ON'
False or 0(Preset value)	Set delta marker mode to 'OFF'

Equivalent key

USER Menu -&gt; Marker -&gt; More Functions -&gt; Ref Marker Mode

**SCPI.CALCulate.USER(1-1).TRACe(1-8).ALLMarker.ACTive**

Syntax

SCPI.CALCulate.USER(1-1).TRACe(1-8).ALLMarker.ACTive = &lt;long&gt;

&lt;long&gt; = SCPI.CALCulate.USER(1-1).TRACe(1-8).ALLMarker.ACTive

Description

Selects active marker

Variable

	<b>&lt;Long&gt;</b>
Range	1 to 6
Preset value	1
Unit	-
Resolution	-

Equivalent key

No equivalent key is available on the front panel.

**SCPI.CALCulate.USER(1-1).TRACe(1-8).ALLMarker.SEARCh.DOMain.X**

Syntax

SCPI.CALCulate.USER(1-1).TRACe(1-8).ALLMarker.SEARCh.DOMain.X = &lt;string&gt;

&lt;string&gt; = SCPI.CALCulate.USER(1-1).TRACe(1-8).ALLMarker.SEARCh.DOMain.X

Description

Sets/reads the marker search range (X-axis)

Variable

	<b>Param</b>
FRANge(Preset value)	Set marker search X range to 'FRANge' (full range)
BDMarker	Set marker search X range to 'BDMarker' (Specified range by bandmarker X)

Equivalent key USER Menu -> Marker Search -> Search Range (X)

### SCPI.CALCulate.USER(1-1).TRACe(1-8).ALLMarker.SEA Rch.DOMain.Y

Syntax SCPI.CALCulate.USER(1-1).TRACe(1-8).ALLMarker.SEARch.DOMain.Y = <string>  
<string> = SCPI.CALCulate.USER(1-1).TRACe(1-8).ALLMarker.SEARch.DOMain.Y

Description Sets/reads marker search range (Y-axis)

Variable

	Param
FRANge(Preset value)	Set marker search Y range to 'FRANge' (full range)
BDMarker	Set marker search Y range to 'BDMarker' (sspecified range by bandmarker)

Equivalent key USER Menu -> Marker Search -> Search Range (Y)

### SCPI.CALCulate.USER(1-1).TRACe(1-8).ALLMarker.SEA Rch.PEAK

Syntax SCPI.CALCulate.USER(1-1).TRACe(1-8).ALLMarker.SEARch.PEAK

Description Execute marker peak search all (No Read)

Equivalent key USER Menu -> Marker Search -> Peak -> Search Peak All

### SCPI.CALCulate.USER(1-1).TRACe(1-8).BDMarker.X.CE Nter

Syntax SCPI.CALCulate.USER(1-1).TRACe(1-8).BDMarker.X.CENter = <double>  
<double> = SCPI.CALCulate.USER(1-1).TRACe(1-8).BDMarker.X.CENter

Description Sets/reads the center value of bandmarker X

Variable

	<Double>
Range	-1T to 1T
Preset value	0
Unit	-

	<b>&lt;Double&gt;</b>
Resolution	-

Equivalent key USER Menu -> Marker Function -> Band Marker X -> Center  
 USER Menu -> Marker Search -> Band Marker X -> Center

## **SCPI.CALCulate.USER(1-1).TRACe(1-8).BDMarker.X.SPAN**

Syntax SCPI.CALCulate.USER(1-1).TRACe(1-8).BDMarker.X.SPAN = <double>  
 <double> = SCPI.CALCulate.USER(1-1).TRACe(1-8).BDMarker.X.SPAN

Description Sets/reads the span value of bandmarker X

Variable

	<b>&lt;Double&gt;</b>
Range	0 to 2T
Preset value	2T
Unit	-
Resolution	-

Equivalent key USER Menu -> Marker Function -> Band Marker X -> Span  
 USER Menu -> Marker Search -> Band Marker X -> Span

## **SCPI.CALCulate.USER(1-1).TRACe(1-8).BDMarker.X.STARt**

Syntax SCPI.CALCulate.USER(1-1).TRACe(1-8).BDMarker.X.STARt = <double>  
 <double> = SCPI.CALCulate.USER(1-1).TRACe(1-8).BDMarker.X.STARt

Description Sets/reads the start value of bandmarker X

Variable

	<b>&lt;Double&gt;</b>
Range	-1T to 1T
Preset value	-1T
Unit	-
Resolution	-

Equivalent key  
 USER Menu -> Marker Function -> Band Marker X -> Start  
 USER Menu -> Marker Search -> Band Marker X -> Start

### SCPI.CALCulate.USER(1-1).TRACe(1-8).BDMarker.X.STATe

Syntax  
 SCPI.CALCulate.USER(1-1).TRACe(1-8).BDMarker.X.STATe = <boolean>  
 <boolean> = SCPI.CALCulate.USER(1-1).TRACe(1-8).BDMarker.X.STATe

Description  
 Turns on/off bandmarker X

Variable

	Param
True or -1	Set bandmarker X to 'ON'
False or 0(Preset value)	Set bandmarker X to 'OFF'

Equivalent key  
 USER Menu -> Marker Function -> Band Marker X -> Band Marker X  
 USER Menu -> Marker Search -> Band Marker X -> Band Marker X

### SCPI.CALCulate.USER(1-1).TRACe(1-8).BDMarker.X.STOP

Syntax  
 SCPI.CALCulate.USER(1-1).TRACe(1-8).BDMarker.X.STOP = <double>  
 <double> = SCPI.CALCulate.USER(1-1).TRACe(1-8).BDMarker.X.STOP

Description  
 Sets/reads the stop value of bandmarker X

Variable

	<Double>
Range	-1T to 1T
Preset value	1T
Unit	-
Resolution	-

Equivalent key  
 USER Menu -> Marker Function -> Band Marker X -> Stop  
 USER Menu -> Marker Search -> Band Marker X -> Stop

**SCPI.CALCulate.USER(1-1).TRACe(1-8).BDMarker.Y.CENTer**

Syntax SCPI.CALCulate.USER(1-1).TRACe(1-8).BDMarker.Y.CENTer = <double>  
<double> = SCPI.CALCulate.USER(1-1).TRACe(1-8).BDMarker.Y.CENTer

Description Sets/reads the center value of bandmarker Y

Variable

	<Double>
Range	-1T to 1T
Preset value	0
Unit	-
Resolution	-

Equivalent key USER Menu -> Marker Function -> Band Marker Y -> Center  
USER Menu -> Marker Search -> Band Marker Y -> Center

**SCPI.CALCulate.USER(1-1).TRACe(1-8).BDMarker.Y.SPAN**

Syntax SCPI.CALCulate.USER(1-1).TRACe(1-8).BDMarker.Y.SPAN = <double>  
<double> = SCPI.CALCulate.USER(1-1).TRACe(1-8).BDMarker.Y.SPAN

Description Sets/reads the span value of bandmarker Y

Variable

	<Double>
Range	0 to 2T
Preset value	2T
Unit	-
Resolution	-

Equivalent key USER Menu -> Marker Function -> Band Marker Y -> Span  
USER Menu -> Marker Search -> Band Marker Y -> Span



## **SCPI.CALCulate.USER(1-1).TRACe(1-8).BDMarker.Y.STARt**

**Syntax** SCPI.CALCulate.USER(1-1).TRACe(1-8).BDMarker.Y.STARt = <double>  
 <double> = SCPI.CALCulate.USER(1-1).TRACe(1-8).BDMarker.Y.STARt

**Description** Sets/reads the start value of bandmarker Y

**Variable**

	<b>&lt;Double&gt;</b>
Range	-1T to 1T
Preset value	-1T
Unit	-
Resolution	-

**Equivalent key** USER Menu -> Marker Function -> Band Marker Y -> Start  
 USER Menu -> Marker Search -> Band Marker Y -> Start

## **SCPI.CALCulate.USER(1-1).TRACe(1-8).BDMarker.Y.STATe**

**Syntax** SCPI.CALCulate.USER(1-1).TRACe(1-8).BDMarker.Y.STATe = <boolean>  
 <boolean> = SCPI.CALCulate.USER(1-1).TRACe(1-8).BDMarker.Y.STATe

**Description** Turns on/off bandmarker Y

**Variable**

	<b>Param</b>
True or -1	Set bandmarker Y to 'ON'
False or 0(Preset value)	Set bandmarker Y to 'OFF'

**Equivalent key** USER Menu -> Marker Function -> Band Marker Y -> Band Marker Y  
 USER Menu -> Marker Search -> Band Marker Y -> Band Marker Y

## **SCPI.CALCulate.USER(1-1).TRACe(1-8).BDMarker.Y.STOP**

**Syntax** SCPI.CALCulate.USER(1-1).TRACe(1-8).BDMarker.Y.STOP = <double>  
 <double> = SCPI.CALCulate.USER(1-1).TRACe(1-8).BDMarker.Y.STOP

COM Object Reference  
**SCPI.CALCulate.USER(1-1).TRACe(1-8).DATA.COPY**

Description Sets/reads the stop value of bandmarker Y

Variable

	<Double>
Range	-IT to IT
Preset value	IT
Unit	-
Resolution	-

Equivalent key USER Menu -> Marker Function -> Band Marker Y -> Stop

USER Menu -> Marker Search -> Band Marker Y -> Stop

**SCPI.CALCulate.USER(1-1).TRACe(1-8).DATA.COPY**

Syntax SCPI.CALCulate.USER(1-1).TRACe(1-8).DATA.COPY

Description Copies trace data to the user trace (No Query)

Variable

	<Long>
Range	1 to 8
Preset value	-
Unit	-
Resolution	-

Equivalent key USER Menu -> Trace View-> Copy to USER -> Copy to USER1

USER Menu -> Trace View-> Copy to USER -> Copy to USER2

USER Menu -> Trace View-> Copy to USER -> Copy to USER3

USER Menu -> Trace View-> Copy to USER -> Copy to USER4

USER Menu -> Trace View-> Copy to USER -> Copy to USER5

USER Menu -> Trace View-> Copy to USER -> Copy to USER6

USER Menu -> Trace View-> Copy to USER -> Copy to USER7

USER Menu -> Trace View-> Copy to USER -> Copy to USER8

**SCPI.CALCulate.USER(1-1).TRACe(1-8).DATA.FDATA**

Syntax SCPI.CALCulate.USER(1-1).TRACe(1-8).DATA.FDATA = <variant>

<variant> = SCPI.CALCulate.USER(1-1).TRACe(1-8).DATA.FDATA

Description Sets/reads formatted trace data

Variable

	<Variant>
Range	1...1601
Preset value	-
Unit	-
Resolution	-

Equivalent key No equivalent key is available on the front panel.

**SCPI.CALCulate.USER(1-1).TRACe(1-8).DATA.FMEMory**

Syntax SCPI.CALCulate.USER(1-1).TRACe(1-8).DATA.FMEMory = <variant>  
 <variant> = SCPI.CALCulate.USER(1-1).TRACe(1-8).DATA.FMEMory

Description Sets/reads formatted memory data

Variable

	<Variant>
Range	1...1601
Preset value	-
Unit	-
Resolution	-

Equivalent key No equivalent key is available on the front panel.

**SCPI.CALCulate.USER(1-1).TRACe(1-8).DATA.POINts**

Syntax <long> = SCPI.CALCulate.USER(1-1).TRACe(1-8).DATA.POINts

Description Reads the number of measurement points (Read Only)

Equivalent key No equivalent key is available on the front panel.

**SCPI.CALCulate.USER(1-1).TRACe(1-8).DATA.RDATa**

Syntax SCPI.CALCulate.USER(1-1).TRACe(1-8).DATA.RDATa = <variant>  
 <variant> = SCPI.CALCulate.USER(1-1).TRACe(1-8).DATA.RDATa

Description Sets/reads the raw data of the user defined window

Variable

	<Variant>
Range	1...1601
Preset value	-
Unit	-
Resolution	-

Equivalent key No equivalent key is available on the front panel.

**SCPI.CALCulate.USER(1-1).TRACe(1-8).DATA.START**

Syntax <double> = SCPI.CALCulate.USER(1-1).TRACe(1-8).DATA.START

Description Reads the start value of the user defined window trace (Read Only)

Equivalent key No equivalent key is available on the front panel.

**SCPI.CALCulate.USER(1-1).TRACe(1-8).DATA.STOP**

Syntax <double> = SCPI.CALCulate.USER(1-1).TRACe(1-8).DATA.STOP

Description Reads the stop value of the user defined window trace (Read Only)

Equivalent key No equivalent key is available on the front panel.

**SCPI.CALCulate.USER(1-1).TRACe(1-8).DATA.UDATa**

Syntax SCPI.CALCulate.USER(1-1).TRACe(1-8).DATA.UDATa = <variant>  
 <variant> = SCPI.CALCulate.USER(1-1).TRACe(1-8).DATA.UDATa

Description Sets/reads unformatted trace data

Variable

	<Variant>
Range	1...1601
Preset value	-
Unit	-
Resolution	-

Equivalent key No equivalent key is available on the front panel.

## **SCPI.CALCulate.USER(1-1).TRACe(1-8).DATA.UMEMory**

**Syntax** SCPI.CALCulate.USER(1-1).TRACe(1-8).DATA.UMEMory = <variant>  
 <variant> = SCPI.CALCulate.USER(1-1).TRACe(1-8).DATA.UMEMory

**Description** Sets/reads unformatted memory data

**Variable**

	<Variant>
Range	1...1601
Preset value	-
Unit	-
Resolution	-

**Equivalent key** No equivalent key is available on the front panel.

## **SCPI.CALCulate.USER(1-1).TRACe(1-8).DATA.XDATA**

**Syntax** SCPI.CALCulate.USER(1-1).TRACe(1-8).DATA.XDATA = <variant>  
 <variant> = SCPI.CALCulate.USER(1-1).TRACe(1-8).DATA.XDATA

**Description** Sets/reads the X data

**Variable**

	<Variant>
Range	1...1601
Preset value	-
Unit	-
Resolution	-

**Equivalent key** No equivalent key is available on the front panel.

## **SCPI.CALCulate.USER(1-1).TRACe(1-8).FUNCTion.DOMain.X**

**Syntax** SCPI.CALCulate.USER(1-1).TRACe(1-8).FUNCTion.DOMain.X = <string>  
 <string> = SCPI.CALCulate.USER(1-1).TRACe(1-8).FUNCTion.DOMain.X

**Description** Sets/reads analysis/search range (X-axis)

Variable

	Param
FRANge	Set marker search MINimum to 'FRANge' (full range)
BDMarker(Preset value)	Set marker search MINimum to 'BDMarker' (specified range by bandmarker X)

Equivalent key

USER Menu -&gt; Marker Function -&gt; Analysis Range (X)

### SCPI.CALCulate.USER(1-1).TRACe(1-8).FUNCTio.n.DOMain.Y

Syntax

SCPI.CALCulate.USER(1-1).TRACe(1-8).FUNCTio.n.DOMain.Y = &lt;string&gt;

&lt;string&gt; = SCPI.CALCulate.USER(1-1).TRACe(1-8).FUNCTio.n.DOMain.Y

Description

Sets/reads analysis/search range (Y-axis)

Variable

	Param
FRANge	Set marker search PEAK to 'FRANge' (full range)
BDMarker(Preset value)	Set marker search PEAK to 'BDMarker' (specified range by bandmarker Y)

Equivalent key

USER Menu -&gt; Marker Function -&gt; Analysis Range (Y)

### SCPI.CALCulate.USER(1-1).TRACe(1-8).FUNCTio.n.STATistics.DATA\_Q

Syntax

SCPI.CALCulate.USER(1-1).TRACe(1-8).FUNCTio.n.STATistics.DATA\_Q mean, std\_dev, peak\_to\_peak

Description

Reads the results of statistical analysis of the trace data (Read Only)

Examples

```
Dim meas As Double
Dim s_dev As Double
Dim p_p As Double
```

```
SCPI.CALCulate.USER.TRACe.FUNCTio.n.STATistics.DATA_Q mean, s_dev, p_p
```

Equivalent key

No equivalent key is available on the front panel.

**SCPI.CALCulate.USER(1-1).TRACe(1-8).FUNCTion.STATistics.MEMory\_Q**

**Syntax** SCPI.CALCulate.USER(1-1).TRACe(1-8).FUNCTion.STATistics.MEMory\_Q mean, std\_dev, peak\_to\_peak

**Description** Reads the results of statistical analysis of the memory trace (Read Only)

**Examples**

```
Dim meas As Double
Dim s_dev As Double
Dim p_p As Double

SCPI.CALCulate.USER.TRACe.FUNCTion.STATistics.MEMory_Q mean, s_dev, p_p
```

**Equivalent key** No equivalent key is available on the front panel.

**SCPI.CALCulate.USER(1-1).TRACe(1-8).FUNCTion.TYPE**

**Syntax** SCPI.CALCulate.USER(1-1).TRACe(1-8).FUNCTion.TYPE = <string>  
<string> = SCPI.CALCulate.USER(1-1).TRACe(1-8).FUNCTion.TYPE

**Description** Selects analysis type

**Variable**

	Param
OFF(Preset value)	Set marker search TARGeT to 'OFF'
STATistics	Set marker search TARGeT to 'STATistics'

**Equivalent key** USER Menu -> Marker Function -> Analysis Type

**SCPI.CALCulate.USER(1-1).TRACe(1-8).HOLD**

**Syntax** SCPI.CALCulate.USER(1-1).TRACe(1-8).HOLD = <string>  
<string> = SCPI.CALCulate.USER(1-1).TRACe(1-8).HOLD

**Description** Selects data hold type

**Variable**

	Param
OFF(Preset value)	Set data hold type to 'OFF'
MAXimum	Set data hold type to 'MAXimum'
MINimum	Set data hold type to 'MINimum'

COM Object Reference  
**SCPI.CALCulate.USER(1-1).TRACe(1-8).LIMit.FAIL**

Equivalent key USER Menu -> Trace View -> Data Hold

**SCPI.CALCulate.USER(1-1).TRACe(1-8).LIMit.FAIL**

<boolean> = SCPI.CALCulate.USER(1-1).TRACe(1-8).LIMit.FAIL

Description Reads out the limit test result (Query Only)

Variable

	Param
True or -1	The limit test result is fail
False or 0(Preset value)	The limit test result is pass

When the limit test is set to OFF, false or 0 is always read out.

Equivalent key No equivalent key is available on the front panel.

**SCPI.CALCulate.USER(1-1).TRACe(1-8).LIMit.LOWer.LD  
 ATa**

Syntax SCPI.CALCulate.USER(1-1).TRACe(1-8).LIMit.LOWer.LDATa = <variant>  
 <variant> = SCPI.CALCulate.USER(1-1).TRACe(1-8).LIMit.LOWer.LDATa

Description Sets/reads the lower limit values of all measurement points

Variable

	<Variant>
Range	1...1601
Preset value	-
Unit	-
Resolution	-

Equivalent key No equivalent key is available on the front panel.

**SCPI.CALCulate.USER(1-1).TRACe(1-8).LIMit.LOWer.SEGMent.CLEAr**

Syntax SCPI.CALCulate.USER(1-1).TRACe(1-8).LIMit.LOWer.SEGMent.CLEAr

Description Clears the lower limit line (No Query)

Equivalent key USER Menu -> Display -> Limit Test -> Delete Lower Limit Line



**SCPI.CALCulate.USER(1-1).TRACe(1-8).LIMit.LOWer.SEGMent.COUNT**

Syntax SCPI.CALCulate.USER(1-1).TRACe(1-8).LIMit.LOWer.SEGMent.COUNT = <long>  
 <long> = SCPI.CALCulate.USER(1-1).TRACe(1-8).LIMit.LOWer.SEGMent.COUNT

Description Sets/reads the number of segments in the lower limit line

Variable

	<Long>
Range	1 to 100
Preset value	1
Unit	-
Resolution	-

Equivalent key No equivalent key is available on the front panel.

**SCPI.CALCulate.USER(1-1).TRACe(1-8).LIMit.LOWer.SEGMent.DATA**

Syntax SCPI.CALCulate.USER(1-1).TRACe(1-8).LIMit.LOWer.SEGMent.DATA = <variant>  
 <variant> = SCPI.CALCulate.USER(1-1).TRACe(1-8).LIMit.LOWer.SEGMent.DATA

Description Sets/reads segment data of the lower limit line

Variable

	<Variant>
Range	1..400
Preset value	-
Unit	-
Resolution	-

Equivalent key No equivalent key is available on the front panel.

**SCPI.CALCulate.USER(1-1).TRACe(1-8).LIMit.REPport.DATA**

<variant> = SCPI.CALCulate.USER(1-1).TRACe(1-8).LIMit.REPport.DATA

Description Reads the limit test results of all measurement points in selected traces (Query Only)

Equivalent key No equivalent key is available on the front panel.

### **SCPI.CALCulate.USER(1-1).TRACe(1-8).LIMit.STATe**

Syntax SCPI.CALCulate.USER(1-1).TRACe(1-8).LIMit.STATe = <boolean>

<boolean> = SCPI.CALCulate.USER(1-1).TRACe(1-8).LIMit.STATe

Description Turns on/off the limit test function

Variable

	<b>Param</b>
True or -1	Turn on the limit test function mode
False or 0(Preset value)	Turn off the limit test function mode

Equivalent key USER Menu -> Display -> Limit Test -> Limit Test

### **SCPI.CALCulate.USER(1-1).TRACe(1-8).LIMit.UPPer.LDAta**

Syntax SCPI.CALCulate.USER(1-1).TRACe(1-8).LIMit.UPPer.LDAta = <variant>

<variant> = SCPI.CALCulate.USER(1-1).TRACe(1-8).LIMit.UPPer.LDAta

Description Sets/reads the upper limit values of all measurement points

Variable

	<b>&lt;Variant&gt;</b>
Range	1...1601
Preset value	-
Unit	-
Resolution	-

Equivalent key No equivalent key is available on the front panel.

### **SCPI.CALCulate.USER(1-1).TRACe(1-8).LIMit.UPPer.SEGMent.CLEAr**

Syntax SCPI.CALCulate.USER(1-1).TRACe(1-8).LIMit.UPPer.SEGMent.CLEAr

Description Clears the upper limit line (No Query)

Equivalent key USER Menu -> Display -> Limit Test -> Delete Upper Limit Line

**SCPI.CALCulate.USER(1-1).TRACe(1-8).LIMit.UPPer.SEGMent.COUNT**

Syntax SCPI.CALCulate.USER(1-1).TRACe(1-8).LIMit.UPPer.SEGMent.COUNT = <long>  
 <long> = SCPI.CALCulate.USER(1-1).TRACe(1-8).LIMit.UPPer.SEGMent.COUNT

Description Sets/reads the number of segments in the upper limit line

Variable

	<Long>
Range	1 to 100
Preset value	1
Unit	-
Resolution	-

Equivalent key No equivalent key is available on the front panel.

**SCPI.CALCulate.USER(1-1).TRACe(1-8).LIMit.UPPer.SEGMent.DATA**

Syntax SCPI.CALCulate.USER(1-1).TRACe(1-8).LIMit.UPPer.SEGMent.DATA = <variant>  
 <variant> = SCPI.CALCulate.USER(1-1).TRACe(1-8).LIMit.UPPer.SEGMent.DATA

Description Sets/reads segment data of the upper limit line

Variable

	<Variant>
Range	1..400
Preset value	-
Unit	-
Resolution	-

Equivalent key No equivalent key is available on the front panel.

**SCPI.CALCulate.USER(1-1).TRACe(1-8).MARKer(1-6).SEARCH.EXECute.LPEak**

Syntax SCPI.CALCulate.USER(1-1).TRACe(1-8).MARKer(1-6).SEARCH.EXECute.LPEak

Description Execute marker peak search left (No Read)

Equivalent key USER Menu -> Marker Search -> Peak -> Search Left

**SCPI.CALCulate.USER(1-1).TRACe(1-8).MARKer(1-6).SE  
ARch.EXECute.LTARget**

Syntax SCPI.CALCulate.USER(1-1).TRACe(1-8).MARKer(1-6).SEARch.EXECute.LTARget

Description Execute marker target search left (No Read)

Equivalent key USER Menu -> Marker Search -> Target -> Search Left

**SCPI.CALCulate.USER(1-1).TRACe(1-8).MARKer(1-6).SE  
ARch.EXECute.MAXimum**

Syntax SCPI.CALCulate.USER(1-1).TRACe(1-8).MARKer(1-6).SEARch.EXECute.MAXimum

Description Execute marker search maximum (No Read)

Equivalent key USER Menu -> Marker Search -> Search Max

**SCPI.CALCulate.USER(1-1).TRACe(1-8).MARKer(1-6).SE  
ARch.EXECute.MINimum**

Syntax SCPI.CALCulate.USER(1-1).TRACe(1-8).MARKer(1-6).SEARch.EXECute.MINimum

Description Execute marker search minimum (No Read)

Equivalent key USER Menu -> Marker Search -> Search Min

**SCPI.CALCulate.USER(1-1).TRACe(1-8).MARKer(1-6).SE  
ARch.EXECute.PEAK**

Syntax SCPI.CALCulate.USER(1-1).TRACe(1-8).MARKer(1-6).SEARch.EXECute.PEAK

Description Execute marker peak search (No Read)

Equivalent key USER Menu -> Marker Search -> Peak -> Search Peak

**SCPI.CALCulate.USER(1-1).TRACe(1-8).MARKer(1-6).SE  
ARch.EXECute.RPEak**

Syntax SCPI.CALCulate.USER(1-1).TRACe(1-8).MARKer(1-6).SEARch.EXECute.RPEak

Description Execute marker peak search right (No Read)

Equivalent key USER Menu -> Marker Search -> Peak -> Search Right

Syntax	SCPI.CALCulate.USER(1-1).TRACe(1-8).MARKer(1-6).SEARCh.EXECute.RTARget
Description	Execute marker target search right (No Read)
Equivalent key	USER Menu -> Marker Search -> Target -> Search Right

**SCPI.CALCulate.USER(1-1).TRACe(1-8).MARKer(1-6).SE  
ARCh.EXECute.TARGet**

Syntax	SCPI.CALCulate.USER(1-1).TRACe(1-8).MARKer(1-6).SEARCh.EXECute.TARGet
Description	Execute marker target search (No Read)
Equivalent key	USER Menu -> Marker Search -> Target -> Search Target

**SCPI.CALCulate.USER(1-1).TRACe(1-8).MARKer(1-6).SE  
ARCh.PEAK.EXCursion**

Syntax	SCPI.CALCulate.USER(1-1).TRACe(1-8).MARKer(1-6).SEARCh.PEAK.EXCursion = <double>  <double> = SCPI.CALCulate.USER(1-1).TRACe(1-8).MARKer(1-6).SEARCh.PEAK.EXCursion
--------	--

Description Sets/reads the peak excursion value

Variable

	<Double>
Range	0 to 10G
Preset value	0
Unit	-
Resolution	-

Equivalent key USER Menu -> Marker Search -> Peak -> Peak Excursion

**SCPI.CALCulate.USER(1-1).TRACe(1-8).MARKer(1-6).SE  
ARCh.PEAK.POLarity**

Syntax	SCPI.CALCulate.USER(1-1).TRACe(1-8).MARKer(1-6).SEARCh.PEAK.POLarity = <string>  <string> = SCPI.CALCulate.USER(1-1).TRACe(1-8).MARKer(1-6).SEARCh.PEAK.POLarity
--------	--

**SCPI.CALCulate.USER(1-1).TRACe(1-8).MARKer(1-6).SEARch.TARGet.TRANsition**

Description Sets/reads the marker peak-search polarity

Variable

	<b>Param</b>
POSitive(Preset value)	Set marker-search-peak polarity type to 'POSitive'
NEGative	Set marker-search-peak polarity type to 'NEGative'
BOTH	Set marker-search-peak polarity type to 'BOTH'

Equivalent key USER Menu -> Marker Search -> Peak -> Peak Polarity

**SCPI.CALCulate.USER(1-1).TRACe(1-8).MARKer(1-6).SEARch.TARGet.TRANSition**

Syntax SCPI.CALCulate.USER(1-1).TRACe(1-8).MARKer(1-6).SEARch.TARGet.TRANSition = <string>

<string> =

SCPI.CALCulate.USER(1-1).TRACe(1-8).MARKer(1-6).SEARch.TARGet.TRANSition

Description Sets/reads the target transition definition

Variable

	<b>Param</b>
POSitive	Set marker-target transition type to 'POSitive'
NEGative	Set marker-target transition type to 'NEGative'
BOTH(Preset value)	Set marker-target transition type to 'BOTH'

Equivalent key USER Menu -> Marker Search -> Target -> Target Transition

**SCPI.CALCulate.USER(1-1).TRACe(1-8).MARKer(1-6).SEARch.TARGet.Y**

Syntax SCPI.CALCulate.USER(1-1).TRACe(1-8).MARKer(1-6).SEARch.TARGet.Y = <double>

<double> =

SCPI.CALCulate.USER(1-1).TRACe(1-8).MARKer(1-6).SEARch.TARGet.Y

Description Sets/reads the marker target value

Variable

	<Double>
Range	-10G to 10G
Preset value	0
Unit	-
Resolution	-

Equivalent key

USER Menu -&gt; Marker Search -&gt; Target -&gt; Target Value

### SCPI.CALCulate.USER(1-1).TRACe(1-8).MARKer(1-6).SEARch.TRACKing.TY PE

Syntax

SCPI.CALCulate.USER(1-1).TRACe(1-8).MARKer(1-6).SEARch.TRACKing.TY =  
<string>

&lt;string&gt; =

SCPI.CALCulate.USER(1-1).TRACe(1-8).MARKer(1-6).SEARch.TRACKing.TY

Description

Sets/reads the marker tracking type

Variable

	Param
OFF(Preset value)	Set search tracking type to 'OFF'
MAXimum	Set search tracking type to 'MAXimum'
MINimum	Set search tracking type to 'MINimum'
PEAK	Set search tracking type to 'PEAK'
TARGet	Set search tracking type to 'TARGet'

Equivalent key

USER Menu -&gt; Marker Search -&gt; Tracking

### SCPI.CALCulate.USER(1-1).TRACe(1-8).MARKer(1-6).STATe

Syntax

SCPI.CALCulate.USER(1-1).TRACe(1-8).MARKer(1-6).STATe = &lt;boolean&gt;

&lt;boolean&gt; = SCPI.CALCulate.USER(1-1).TRACe(1-8).MARKer(1-6).STATe

Description

Turns on/off a marker

Variable

	<b>Param</b>
True or -1	Enable a marker
False or 0(Preset value)	Disable a marker

Equivalent key

USER Menu -&gt; Marker -&gt; Clear Marker Menu -&gt; Marker 1

**SCPI.CALCulate.USER(1-1).TRACe(1-8).MARKer(1-6).X**

Syntax

SCPI.CALCulate.USER(1-1).TRACe(1-8).MARKer(1-6).X = &lt;double&gt;

&lt;double&gt; = SCPI.CALCulate.USER(1-1).TRACe(1-8).MARKer(1-6).X

Description

Sets/reads the marker position in X-axis

Variable

	<b>&lt;Double&gt;</b>
Range	-
Preset value	0
Unit	-
Resolution	-

Equivalent key

No equivalent key is available on the front panel.

**SCPI.CALCulate.USER(1-1).TRACe(1-8).MARKer(1-6).Y**

Syntax

&lt;double&gt; = SCPI.CALCulate.USER(1-1).TRACe(1-8).MARKer(1-6).Y

Description

Reads the marker position in Y-axis (Read Only)

Equivalent key

No equivalent key is available on the front panel.

**SCPI.CALCulate.USER(1-1).TRACe(1-8).MATH.FUNCTION**

Syntax

SCPI.CALCulate.USER(1-1).TRACe(1-8).MATH.FUNCTION = &lt;string&gt;

&lt;string&gt; = SCPI.CALCulate.USER(1-1).TRACe(1-8).MATH.FUNCTION

Description

Selects math operation type



Variable

	Param
NORMal(Preset value)	Set math operation type to 'NORMal'
SUBTract	Set math operation type to 'SUBTract'
DIVide	Set math operation type to 'DIVide'
ADD	Set math operation type to 'ADD'
MULTiply	Set math operation type to 'MULTiply'

Equivalent key USER Menu -> Trace View -> Data Math

**SCPI.CALCulate.USER(1-1).TRACe(1-8).MATH.MEMorize**

Syntax SCPI.CALCulate.USER(1-1).TRACe(1-8).MATH.MEMorize

Description Copy data to memory (No Read)

Equivalent key No equivalent key is available on the front panel.

**SCPI.CALCulate.USER(1-1).TRACe(1-8).SMOothing.APErture**

Syntax SCPI.CALCulate.USER(1-1).TRACe(1-8).SMOothing.APERture = <double>  
 <double> = SCPI.CALCulate.USER(1-1).TRACe(1-8).SMOothing.APERture

Description Sets/reads smoothing aperture value

Variable

	<Double>
Range	50m to 25
Preset value	1.5
Unit	%
Resolution	10m

Equivalent key USER Menu -> Trace View -> Aperture

**SCPI.CALCulate.USER(1-1).TRACe(1-8).SMOothing.STATe**

**Syntax** SCPI.CALCulate.USER(1-1).TRACe(1-8).SMOothing.STATe = <boolean>  
 <boolean> = SCPI.CALCulate.USER(1-1).TRACe(1-8).SMOothing.STATe

**Description** Turns on/off smoothing function

**Variable**

	<b>Param</b>
True or -1	Set smoothing function to 'ON'
False or 0(Preset value)	Set smoothing function to 'OFF'

**Equivalent key** USER Menu -> Trace View -> Smoothing

**SCPI.CONTRol.HANDler.A.DATA**

**Syntax** SCPI.CONTRol.HANDler.A.DATA

**Description** Outputs data using port A (No Read)

**Variable**

	<b>&lt;Long&gt;</b>
Range	0 to 255
Preset value	-
Unit	-
Resolution	-

**Equivalent key** No equivalent key is available on the front panel.

**SCPI.CONTRol.HANDler.B.DATA**

**Syntax** SCPI.CONTRol.HANDler.B.DATA

**Description** Outputs data using port B (No Read)

**Variable**

	<b>&lt;Long&gt;</b>
Range	0 to 255

	<Long>
Preset value	-
Unit	-
Resolution	-

Equivalent key No equivalent key is available on the front panel.

### **SCPI.CONTRol.HANDler.C.DATA**

Syntax SCPI.CONTRol.HANDler.C.DATA = <long>  
 <long> = SCPI.CONTRol.HANDler.C.DATA

Description Inputs/Outputs data using port C

Variable

	<Long>
Range	0 to 15
Preset value	-
Unit	-
Resolution	-

Equivalent key No equivalent key is available on the front panel.

### **SCPI.CONTRol.HANDler.C.MODE**

Syntax SCPI.CONTRol.HANDler.C.MODE = <string>  
 <string> = SCPI.CONTRol.HANDler.C.MODE

Description Selects input/output mode on port C

Variable

	<b>Param</b>
INPut(Preset value)	Set input/output mode on port C to 'INPut'
OUTPut	Set input/output mode on port C to 'OUTPut'

Equivalent key No equivalent key is available on the front panel.

## **SCPI.CONTRol.HANDler.D.DATA**

Syntax SCPI.CONTRol.HANDler.D.DATA = <long>  
<long> = SCPI.CONTRol.HANDler.D.DATA

Description Inputs/Outputs data using port D

Variable

	<b>&lt;Long&gt;</b>
Range	0 to 15
Preset value	-
Unit	-
Resolution	-

Equivalent key No equivalent key is available on the front panel.

## **SCPI.CONTRol.HANDler.D.MODE**

Syntax SCPI.CONTRol.HANDler.D.MODE = <string>  
<string> = SCPI.CONTRol.HANDler.D.MODE

Description Selects input/output mode on port D

Variable

	<b>Param</b>
INPut(Preset value)	Set input/output mode on port D to 'INPut'
OUTPut	Set input/output mode on port D to 'OUTPut'

Equivalent key No equivalent key is available on the front panel.

## **SCPI.CONTRol.HANDler.E.DATA**

Syntax SCPI.CONTRol.HANDler.E.DATA = <long>  
<long> = SCPI.CONTRol.HANDler.E.DATA

Description Inputs/outputs data using port E(port C + port D; 16 bits)

Variable

	<Long>
Range	0 to 255
Preset value	-
Unit	-
Resolution	-

Equivalent key No equivalent key is available on the front panel.

### **SCPI.CONTRol.HANDler.F.DATA**

Syntax SCPI.CONTRol.HANDler.F.DATA

Description Inputs/outputs data using port F(port A + port C; 16 bits) (No Read)

Variable

	<Long>
Range	0 to 65535
Preset value	-
Unit	-
Resolution	-

Equivalent key No equivalent key is available on the front panel.

### **SCPI.CONTRol.HANDler.OUTPut(1-2).DATA**

Syntax SCPI.CONTRol.HANDler.OUTPut(1-2).DATA = <long>

<long> = SCPI.CONTRol.HANDler.OUTPut(1-2).DATA

Description Sets/Reads OUTPUT1 and/or OUTPUT2

Variable

	<Long>
Range	0 to 1
Preset value	-
Unit	-
Resolution	-

COM Object Reference  
**SCPI.DISPlay.CLOCK**

Equivalent key No equivalent key is available on the front panel.

### **SCPI.DISPlay.CLOCK**

Syntax SCPI.DISPlay.CLOCK = <boolean>  
<boolean> = SCPI.DISPlay.CLOCK

Description Turns on/off internal clock display

Variable

	<b>Param</b>
True or -1 (Preset value)	Set internal clock display mode to 'ON'
False or 0	Set internal clock display mode to 'OFF'

Equivalent key PN Menu -> System -> Misc Setup -> Clock Setup -> Show Clock  
SP Menu -> System -> Misc Setup -> Clock Setup -> Show Clock  
FP Menu -> System -> Misc Setup -> Clock Setup -> Show Clock  
TR Menu -> System -> Misc Setup -> Clock Setup -> Show Clock  
USER Menu -> System -> Misc Setup -> Clock Setup -> Show Clock

### **SCPI.DISPlay.ECHO.ADD**

Syntax SCPI.DISPlay.ECHO.ADD

Description Adds texts in echo window (No Read)

Variable

	<b>&lt;String&gt;</b>
Range	-
Preset value	-
Unit	-
Resolution	-

Equivalent key No equivalent key is available on the front panel.

### **SCPI.DISPlay.ECHO.CLEAr**

Syntax SCPI.DISPlay.ECHO.CLEAr

Description Clears echo window (No Read)

Equivalent key PN Menu -> Macro Setup -> Echo Window Menu -> Clear Echo  
 SP Menu -> Macro Setup -> Echo Window Menu -> Clear Echo  
 FP Menu -> Macro Setup -> Echo Window Menu -> Clear Echo  
 TR Menu -> Macro Setup -> Echo Window Menu -> Clear Echo  
 USER Menu -> Macro Setup -> Echo Window Menu -> Clear Echo

### **SCPI.DISPlay.ECHO.DATA**

Syntax SCPI.DISPlay.ECHO.DATA = <string>  
 <string> = SCPI.DISPlay.ECHO.DATA

Description Sets/reads texts in echo window

Variable

	<b>&lt;String&gt;</b>
Range	-
Preset value	""
Unit	-
Resolution	-

Equivalent key No equivalent key is available on the front panel.

### **SCPI.DISPlay.ECHO.FSIZE**

Syntax SCPI.DISPlay.ECHO.FSIZE = <long>  
 <long> = SCPI.DISPlay.ECHO.FSIZE

Description Sets/reads the font size in echo window

Variable

	<b>&lt;Long&gt;</b>
Range	9 10 11 12 14 16 18 20 22 24 26 28 36 48 72 96 112
Preset value	11
Unit	-
Resolution	-

Equivalent key PN Menu -> Macro Setup -> Echo Window Menu -> Echo Font Size  
 SP Menu -> Macro Setup -> Echo Window Menu -> Echo Font Size  
 FP Menu -> Macro Setup -> Echo Window Menu -> Echo Font Size

TR Menu -> Macro Setup -> Echo Window Menu -> Echo Font Size

USER Menu -> Macro Setup -> Echo Window Menu -> Echo Font Size

## **SCPI.DISPlay.ECHO.STATe**

Syntax SCPI.DISPlay.ECHO.STATe = <boolean>  
<boolean> = SCPI.DISPlay.ECHO.STATe

Description Show/Hide echo window

Variable

	<b>Param</b>
True or -1	Show echo window
False or 0(Preset value)	Hide echo window

Equivalent key PN Menu -> Macro Setup -> Echo Window Menu -> Echo Window  
SP Menu -> Macro Setup -> Echo Window Menu -> Echo Window  
FP Menu -> Macro Setup -> Echo Window Menu -> Echo Window  
TR Menu -> Macro Setup -> Echo Window Menu -> Echo Window  
USER Menu -> Macro Setup -> Echo Window Menu -> Echo Window

## **SCPI.DISPlay.ENABLE**

Syntax SCPI.DISPlay.ENABLE = <boolean>  
<boolean> = SCPI.DISPlay.ENABLE

Description Enable/disable trace update

Variable

	<b>Param</b>
True or -1(Preset value)	Enable trace update
False or 0	Disable trace update

Equivalent key PN Menu -> Display -> Update  
SP Menu -> Display -> Update  
FP Menu -> Display -> Update  
TR Menu -> Display -> Update  
USER Menu -> Display -> Update



### **SCPI.DISPlay.FP(1-1).ALLTrace.PERSistence.CLEAr**

Syntax SCPI.DISPlay.FP(1-1).ALLTrace.PERSistence.CLEAr  
 Description Clears persistence mode in all traces (No Read)  
 Equivalent key No equivalent key is available on the front panel.

### **SCPI.DISPlay.FP(1-1).ALLTrace.Y.SCALE.AUTO**

Syntax SCPI.DISPlay.FP(1-1).ALLTrace.Y.SCALE.AUTO  
 Description Execute autoscale all (No Read)  
 Equivalent key FP Menu -> Scale -> Auto Scale All

### **SCPI.DISPlay.FP(1-1).ANNotation.MARKer.POSition**

Syntax SCPI.DISPlay.FP(1-1).ANNotation.MARKer.POSition = <string>  
 <string> = SCPI.DISPlay.FP(1-1).ANNotation.MARKer.POSition

Description Sets/reads the marker information position

Variable

	<b>Param</b>
LEFT(Preset value)	Set the marker information position to 'LEFT'
RIGHT	Set the marker information position to 'RIGHT'

Equivalent key FP Menu -> Display -> Marker Information

### **SCPI.DISPlay.FP(1-1).ANNotation.MEASurement.STATe**

Syntax SCPI.DISPlay.FP(1-1).ANNotation.MEASurement.STATe = <boolean>  
 <boolean> = SCPI.DISPlay.FP(1-1).ANNotation.MEASurement.STATe

Description Turns on/off measurement conditions

Variable

	<b>Param</b>
True or -1(Preset value)	Show measurement conditions
False or 0	Hide measurement conditions

Equivalent key FP Menu -> Display -> Meas Condition

### **SCPI.DISPlay.FP(1-1).GRATicule.AXIS.Y.RELative**

Syntax SCPI.DISPlay.FP(1-1).GRATicule.AXIS.Y.RELative = <boolean>  
<boolean> = SCPI.DISPlay.FP(1-1).GRATicule.AXIS.Y.RELative

Description Turns on/off relative Y-scale

Variable

	<b>Param</b>
True or -1	Set relative Y-scale mode to 'ON'
False or 0(Preset value)	Set relative Y-scale mode to 'OFF'

Equivalent key FP Menu -> Display -> Relative Y-Scale

### **SCPI.DISPlay.FP(1-1).GRATicule.AXIS.Y.STATe**

Syntax SCPI.DISPlay.FP(1-1).GRATicule.AXIS.Y.STATe = <string>  
<string> = SCPI.DISPlay.FP(1-1).GRATicule.AXIS.Y.STATe

Description Show/Hide Y graticule label

Variable

	<b>Param</b>
OFF	Set Y graticule label to 'OFF'
SHORT(Preset value)	Set Y graticule label to 'SHORT'
LONG	Set Y graticule label to 'LONG'

Equivalent key FP Menu -> Display -> Y # of Digits

### **SCPI.DISPlay.FP(1-1).LABel.DATA**

Syntax SCPI.DISPlay.FP(1-1).LABel.DATA = <string>  
<string> = SCPI.DISPlay.FP(1-1).LABel.DATA

Description Sets/reads the window title label

Variable

	<String>
Range	-
Preset value	""
Unit	-
Resolution	-

Equivalent key FP Menu -> Display -> Edit Title Label

**SCPI.DISPlay.FP(1-1).LABel.STATe**

Syntax SCPI.DISPlay.FP(1-1).LABel.STATe = <boolean>  
 <boolean> = SCPI.DISPlay.FP(1-1).LABel.STATe

Description Show/Hide window title label

Variable

	Param
True or -1	Set window title label to 'ON'
False or 0(Preset value)	Set window title label to 'OFF'

Equivalent key FP Menu -> Display -> Title Label

**SCPI.DISPlay.FP(1-1).LIMit.FSIGn**

Syntax SCPI.DISPlay.FP(1-1).LIMit.FSIGn = <boolean>  
 <boolean> = SCPI.DISPlay.FP(1-1).LIMit.FSIGn

Description Turns on/off the limit test judgement display

Variable

	Param
True or -1(Preset value)	Turn on the limit test judgement display mode
False or 0	Turn off the limit test judgement display mode

Equivalent key FP Menu -> Display -> Limit Test -> Fail Sign

## **SCPI.DISPlay.FP(1-1).MAXimize**

Syntax SCPI.DISPlay.FP(1-1).MAXimize = <boolean>  
<boolean> = SCPI.DISPlay.FP(1-1).MAXimize

Description Maximize active trace

Variable

	<b>Param</b>
True or -1	Maximize selected active trace
False or 0(Preset value)	Restore all the trace

Equivalent key No equivalent key is available on the front panel.

## **SCPI.DISPlay.FP(1-1).SPLit**

Syntax SCPI.DISPlay.FP(1-1).SPLit = <string>  
<string> = SCPI.DISPlay.FP(1-1).SPLit

Description Sets/reads the trace layout

Variable

	<b>Param</b>
D11_23(Preset value)	Set the trace layout to 'x3'
D12_34	Set the trace layout to 'x4'

Equivalent key FP Menu -> Display -> Allocate

## **SCPI.DISPlay.FP(1-1).STATe**

Syntax SCPI.DISPlay.FP(1-1).STATe = <boolean>  
<boolean> = SCPI.DISPlay.FP(1-1).STATe

Description Turns on/off frequency, power, and DC current measurement mode

Variable

	<b>Param</b>
True or -1(Preset value)	Set FP measurement mode to 'ON'

	Param
False or 0	Set FP measurement mode to 'OFF'

Equivalent key  
 PN Menu -> Measurement View -> Show Window -> Freq & Power  
 SP Menu -> Measurement View -> Show Window -> Freq & Power  
 FP Menu -> Measurement View -> Show Window -> Freq & Power  
 TR Menu -> Measurement View -> Show Window -> Freq & Power  
 USER Menu -> Measurement View -> Show Window -> Freq & Power

### **SCPI.DISPlay.FP(1-1).TABLE.STATe**

Syntax  
 SCPI.DISPlay.FP(1-1).TABLE.STATe = <boolean>  
 <boolean> = SCPI.DISPlay.FP(1-1).TABLE.STATe

Description  
 Turns on/off the marker list

Variable

	Param
True or -1	Show marker list
False or 0(Preset value)	Hide marker list

Equivalent key  
 FP Menu -> Marker -> Marker List

### **SCPI.DISPlay.FP(1-1).TRACe(1-4).LABel.DATA**

Syntax  
 SCPI.DISPlay.FP(1-1).TRACe(1-4).LABel.DATA = <string>  
 <string> = SCPI.DISPlay.FP(1-1).TRACe(1-4).LABel.DATA

Description  
 Edits trace title label

Variable

	<String>
Range	-
Preset value	"Freq"
Unit	-
Resolution	-

Equivalent key  
 FP Menu -> Trace View -> Trace Label

## **SCPI.DISPlay.FP(1-1).TRACe(1-4).LIMit.LINE**

Syntax SCPI.DISPlay.FP(1-1).TRACe(1-4).LIMit.LINE = <boolean>  
<boolean> = SCPI.DISPlay.FP(1-1).TRACe(1-4).LIMit.LINE

Description Turns on/off the limit line

Variable

	<b>Param</b>
True or -1(Preset value)	Turn on the limit line mode
False or 0	Turn off the limit line mode

Equivalent key FP Menu -> Display -> Limit Test -> Limit Line

## **SCPI.DISPlay.FP(1-1).TRACe(1-4).MODE**

Syntax SCPI.DISPlay.FP(1-1).TRACe(1-4).MODE = <string>  
<string> = SCPI.DISPlay.FP(1-1).TRACe(1-4).MODE

Description Shows data and/or memory trace

Variable

	<b>Param</b>
OFF	Hides data and memory trace
DATA(Preset value)	Shows data trace only
MEMory	Shows memory trace only
BOTH	Shows both data and memory trace

Equivalent key FP Menu -> Trace View -> Display Trace

## **SCPI.DISPlay.FP(1-1).TRACe(1-4).PERSistence.CLEAr**

Syntax SCPI.DISPlay.FP(1-1).TRACe(1-4).PERSistence.CLEAr

Description Cleasr persistence mode (No Read)

Equivalent key FP Menu -> Trace View -> Persistence -> Clear Persistent Data

## SCPI.DISPlay.FP(1-1).TRACe(1-4).PERSistence.STATe

**Syntax** SCPI.DISPlay.FP(1-1).TRACe(1-4).PERSistence.STATe = <boolean>  
 <boolean> = SCPI.DISPlay.FP(1-1).TRACe(1-4).PERSistence.STATe

**Description** Sets/reads persistence mode

**Variable**

	<b>Param</b>
True or -1	Set persistence mode to 'ON'
False or 0(Preset value)	Set persistence mode to 'OFF'

**Equivalent key** FP Menu -> Trace View -> Persistence -> Persistence Mode

## SCPI.DISPlay.FP(1-1).TRACe(1-4).Y.SCALe.AUTO

**Syntax** SCPI.DISPlay.FP(1-1).TRACe(1-4).Y.SCALe.AUTO

**Description** Execute autoscale (No Read)

**Equivalent key** FP Menu -> Scale -> Auto Scale

## SCPI.DISPlay.FP(1-1).TRACe(1-4).Y.SCALe.PDIVision

**Syntax** SCPI.DISPlay.FP(1-1).TRACe(1-4).Y.SCALe.PDIVision = <double>  
 <double> = SCPI.DISPlay.FP(1-1).TRACe(1-4).Y.SCALe.PDIVision

**Description** Sets/reads scale per division

**Variable**

	<b>&lt;Double&gt;</b>
Range	1a to 10G
Preset value	100M
Unit	-
Resolution	-

**Equivalent key** FP Menu -> Scale -> Scale/Div

## SCPI.DISPlay.FP(1-1).TRACe(1-4).Y.SCALe.RLEVel

**Syntax** SCPI.DISPlay.FP(1-1).TRACe(1-4).Y.SCALe.RLEVel = <double>

COM Object Reference  
**SCPI.DISPlay.FP(1-1).TRACe(1-4).Y.SCALe.RPOStion**

<double> = SCPI.DISPlay.FP(1-1).TRACe(1-4).Y.SCALe.RLEVel

Description Sets/reads the scale reference level

Variable

	<b>&lt;Double&gt;</b>
Range	-50G to 50G
Preset value	1.5G
Unit	-
Resolution	-

Equivalent key FP Menu -> Scale -> Reference Value

FP Menu -> Scale -> Marker -> Reference

**SCPI.DISPlay.FP(1-1).TRACe(1-4).Y.SCALe.RPOStion**

Syntax SCPI.DISPlay.FP(1-1).TRACe(1-4).Y.SCALe.RPOStion = <long>

<long> = SCPI.DISPlay.FP(1-1).TRACe(1-4).Y.SCALe.RPOStion

Description Sets/reads scale reference position

Variable

	<b>&lt;Long&gt;</b>
Range	0 to 30
Preset value	5
Unit	Div
Resolution	-

Equivalent key FP Menu -> Scale -> Reference Position

**SCPI.DISPlay.FP(1-1).Y.SCALe.DIVisions**

Syntax SCPI.DISPlay.FP(1-1).Y.SCALe.DIVisions = <long>

<long> = SCPI.DISPlay.FP(1-1).Y.SCALe.DIVisions

Description Sets/reads the number of Y-scale division



Variable

	<Long>
Range	4 to 30
Preset value	10
Unit	-
Resolution	2

Equivalent key FP Menu -> Scale -> Divisions

### **SCPI.DISPlay.MAXimize**

Syntax SCPI.DISPlay.MAXimize = <boolean>  
 <boolean> = SCPI.DISPlay.MAXimize

Description Maximize active measurement window

Variable

	Param
True or -1(Preset value)	Maximize active measurement window
False or 0	Restore active measurement window'

Equivalent key No equivalent key is available on the front panel.

### **SCPI.DISPlay.MESSage.CLEAr**

Syntax SCPI.DISPlay.MESSage.CLEAr

Description Clear caution/message (No Read)

Equivalent key No equivalent key is available on the front panel.

### **SCPI.DISPlay.PN(1-1).ALLTrace.PERSistence.CLEAr**

Syntax SCPI.DISPlay.PN(1-1).ALLTrace.PERSistence.CLEAr

Description Clears all persistent traces (No Read)

Equivalent key No equivalent key is available on the front panel.

## **SCPI.DISPlay.PN(1-1).ANNotation.MARKeR.POSition**

Syntax SCPI.DISPlay.PN(1-1).ANNotation.MARKeR.POSition = <string>  
<string> = SCPI.DISPlay.PN(1-1).ANNotation.MARKeR.POSition

Description Sets/reads the marker information position

Variable

	<b>Param</b>
LEFT	Set the marker information position to 'LEFT'
RIGHt(Preset value)	Set the marker information position to 'RIGHT'

Equivalent key PN Menu -> Display -> Marker Information

## **SCPI.DISPlay.PN(1-1).ANNotation.MEASurement.STATe**

Syntax SCPI.DISPlay.PN(1-1).ANNotation.MEASurement.STATe = <boolean>  
<boolean> = SCPI.DISPlay.PN(1-1).ANNotation.MEASurement.STATe

Description Turns on/off measurement conditions

Variable

	<b>Param</b>
True or -1(Preset value)	Show measurement conditions
False or 0	Hide measurement conditions

Equivalent key PN Menu -> Display -> Meas Condition

## **SCPI.DISPlay.PN(1-1).GRATicule.AXIS.Y.RELative**

Syntax SCPI.DISPlay.PN(1-1).GRATicule.AXIS.Y.RELative = <boolean>  
<boolean> = SCPI.DISPlay.PN(1-1).GRATicule.AXIS.Y.RELative

Description Sets/reads the graticule label value relative to the reference value

Variable

	<b>Param</b>
True or -1	Set graticule label mode to 'ON'

	Param
False or 0(Preset value)	Set graticule label mode to 'OFF'

Equivalent key PN Menu -> Display -> Relative Y-Scale

### **SCPI.DISPlay.PN(1-1).GRATicule.AXIS.Y.STATe**

Syntax SCPI.DISPlay.PN(1-1).GRATicule.AXIS.Y.STATe = <string>  
 <string> = SCPI.DISPlay.PN(1-1).GRATicule.AXIS.Y.STATe

Description Show/Hide Y graticule label

Variable

	Param
OFF	Set Y graticule label to 'OFF'
SHORT(Preset value)	Set Y graticule label to 'SHORT'
LONG	Set Y graticule label to 'LONG'

Equivalent key PN Menu -> Display -> Y # of Digits

### **SCPI.DISPlay.PN(1-1).LABel.DATA**

Syntax SCPI.DISPlay.PN(1-1).LABel.DATA = <string>  
 <string> = SCPI.DISPlay.PN(1-1).LABel.DATA

Description Edits window title label

Variable

	<String>
Range	-
Preset value	""
Unit	-
Resolution	-

Equivalent key PN Menu -> Display -> Edit Title Label

## **SCPI.DISPlay.PN(1-1).LABel.STATe**

Syntax SCPI.DISPlay.PN(1-1).LABel.STATe = <boolean>  
<boolean> = SCPI.DISPlay.PN(1-1).LABel.STATe

Description Show/Hide window title label

Variable

	<b>Param</b>
True or -1	Show window title label
False or 0(Preset value)	Hide window title label

Equivalent key PN Menu -> Display -> Title Label

## **SCPI.DISPlay.PN(1-1).LIMit.FSIGn**

Syntax SCPI.DISPlay.PN(1-1).LIMit.FSIGn = <boolean>  
<boolean> = SCPI.DISPlay.PN(1-1).LIMit.FSIGn

Description Turns on/off the limit test judgement display

Variable

	<b>Param</b>
True or -1(Preset value)	Turn on the limit test judgement display mode
False or 0	Turn off the limit test judgement display mode

Equivalent key PN Menu -> Display -> Limit Test -> Fail Sign

## **SCPI.DISPlay.PN(1-1).MAXimize**

Syntax SCPI.DISPlay.PN(1-1).MAXimize = <boolean>  
<boolean> = SCPI.DISPlay.PN(1-1).MAXimize

Description Maximize active trace

Variable

	<b>Param</b>
True or -1	Maximize active trace

	Param
False or 0(Preset value)	Restore active trace

Equivalent key No equivalent key is available on the front panel.

### **SCPI.DISPlay.PN(1-1).STaTe**

Syntax SCPI.DISPlay.PN(1-1).STaTe = <boolean>  
 <boolean> = SCPI.DISPlay.PN(1-1).STaTe

Description Turns on/off phase noise measurement mode

Variable

	Param
True or -1(Preset value)	Set phase noise measurement mode to 'ON'
False or 0	Set phase noise measurement mode to 'OFF'

Equivalent key PN Menu -> Measurement View -> Show Window -> Phase Noise  
 SP Menu -> Measurement View -> Show Window -> Phase Noise  
 FP Menu -> Measurement View -> Show Window -> Phase Noise  
 TR Menu -> Measurement View -> Show Window -> Phase Noise  
 USER Menu -> Measurement View -> Show Window -> Phase Noise

### **SCPI.DISPlay.PN(1-1).TABLE.STaTe**

Syntax SCPI.DISPlay.PN(1-1).TABLE.STaTe = <boolean>  
 <boolean> = SCPI.DISPlay.PN(1-1).TABLE.STaTe

Description Turns on/off the marker list

Variable

	Param
True or -1	Show the marker list
False or 0(Preset value)	Hide the marker list

Equivalent key PN Menu -> Marker -> Marker List

## **SCPI.DISPlay.PN(1-1).TRACe(1-1).LABel.DATA**

Syntax SCPI.DISPlay.PN(1-1).TRACe(1-1).LABel.DATA = <string>  
<string> = SCPI.DISPlay.PN(1-1).TRACe(1-1).LABel.DATA

Description Sets/reads trace title label

Variable

	<b>&lt;String&gt;</b>
Range	-
Preset value	"Phase Noise"
Unit	-
Resolution	-

Equivalent key PN Menu -> Trace View -> Trace Label

## **SCPI.DISPlay.PN(1-1).TRACe(1-1).LIMit.LINE**

Syntax SCPI.DISPlay.PN(1-1).TRACe(1-1).LIMit.LINE = <boolean>  
<boolean> = SCPI.DISPlay.PN(1-1).TRACe(1-1).LIMit.LINE

Description Turns on/off the limit line

Variable

	<b>Param</b>
True or -1 (Preset value)	Turn on the limit line mode
False or 0	Turn off the limit line mode

Equivalent key PN Menu -> Display -> Limit Test -> Limit Line

## **SCPI.DISPlay.PN(1-1).TRACe(1-1).MODE**

Syntax SCPI.DISPlay.PN(1-1).TRACe(1-1).MODE = <string>  
<string> = SCPI.DISPlay.PN(1-1).TRACe(1-1).MODE

Description Show data and/or memory trace

Variable

	Param
OFF	Hide data and memory trace
DATA(Preset value)	Show data trace only
MEMory	Show memory trace only
BOTH	Show data and memory trace

Equivalent key PN Menu -> Trace View -> Display Trace

**SCPI.DISPlay.PN(1-1).TRACe(1-1).PERSistence.CLEAr**

Syntax SCPI.DISPlay.PN(1-1).TRACe(1-1).PERSistence.CLEAr

Description Clears persistent data (No Read)

Equivalent key PN Menu -> Trace View -> Persistence -> Clear Persistent Data

**SCPI.DISPlay.PN(1-1).TRACe(1-1).PERSistence.STATe**

Syntax SCPI.DISPlay.PN(1-1).TRACe(1-1).PERSistence.STATe = <boolean>  
 <boolean> = SCPI.DISPlay.PN(1-1).TRACe(1-1).PERSistence.STATe

Description Sets/reads persistence mode

Variable

	Param
True or -1	Set persistence mode to 'ON'
False or 0(Preset value)	Set persistence mode to 'OFF'

Equivalent key PN Menu -> Trace View -> Persistence -> Persistence Mode

**SCPI.DISPlay.PN(1-1).TRACe(1-1).Y.SCALe.AUTO**

Syntax SCPI.DISPlay.PN(1-1).TRACe(1-1).Y.SCALe.AUTO

Description Execute autoscale (No Read)

Equivalent key PN Menu -> Scale -> Auto Scale

## **SCPI.DISPlay.PN(1-1).TRACe(1-1).Y.SCALe.PDIVision**

Syntax SCPI.DISPlay.PN(1-1).TRACe(1-1).Y.SCALe.PDIVision = <double>  
<double> = SCPI.DISPlay.PN(1-1).TRACe(1-1).Y.SCALe.PDIVision

Description scale per division

Variable

	<b>&lt;Double&gt;</b>
Range	1a to 10G
Preset value	10
Unit	-
Resolution	-

Equivalent key PN Menu -> Scale -> Scale/Div

## **SCPI.DISPlay.PN(1-1).TRACe(1-1).Y.SCALe.RLEVel**

Syntax SCPI.DISPlay.PN(1-1).TRACe(1-1).Y.SCALe.RLEVel = <double>  
<double> = SCPI.DISPlay.PN(1-1).TRACe(1-1).Y.SCALe.RLEVel

Description scale reference level

Variable

	<b>&lt;Double&gt;</b>
Range	-50G to 50G
Preset value	-20
Unit	-
Resolution	-

Equivalent key PN Menu -> Scale -> Reference Value  
PN Menu -> Scale -> Marker -> Reference

## **SCPI.DISPlay.PN(1-1).TRACe(1-1).Y.SCALe.RPOSITION**

Syntax SCPI.DISPlay.PN(1-1).TRACe(1-1).Y.SCALe.RPOSITION = <long>  
<long> = SCPI.DISPlay.PN(1-1).TRACe(1-1).Y.SCALe.RPOSITION

Description scale reference position



Variable

	<Long>
Range	0 to 30
Preset value	16
Unit	Div
Resolution	-

Equivalent key PN Menu -> Scale -> Reference Position

**SCPI.DISPlay.PN(1-1).Y.SCALe.DIVisions**

Syntax SCPI.DISPlay.PN(1-1).Y.SCALe.DIVisions = <long>  
 <long> = SCPI.DISPlay.PN(1-1).Y.SCALe.DIVisions

Description # of Y division

Variable

	<Long>
Range	4 to 30
Preset value	16
Unit	-
Resolution	2

Equivalent key PN Menu -> Scale -> Divisions

**SCPI.DISPlay.SKEY.STATe**

Syntax SCPI.DISPlay.SKEY.STATe = <boolean>  
 <boolean> = SCPI.DISPlay.SKEY.STATe

Description Show/Hide soft key

Variable

	<b>Param</b>
True or -1(Preset value)	Show softkeys
False or 0	Hide softkeys

Equivalent key No equivalent key is available on the front panel.

**SCPI.DISPlay.SP(1-1).ALLTrace.PERSistence.CLEAr**

Syntax	SCPI.DISPlay.SP(1-1).ALLTrace.PERSistence.CLEAr
Description	Clears all persistent traces (No Read)
Equivalent key	No equivalent key is available on the front panel.

**SCPI.DISPlay.SP(1-1).ANNotation.MARKer.POSition**

Syntax	SCPI.DISPlay.SP(1-1).ANNotation.MARKer.POSition = <string> <string> = SCPI.DISPlay.SP(1-1).ANNotation.MARKer.POSition
Description	Sets/reads the marker information position
Variable	

	Param
LEFT(Preset value)	Set the marker information position to 'LEFT'
RIGHT	Set the marker information position to 'RIGHT'

Equivalent key	SP Menu -> Display -> Marker Information
----------------	--

**SCPI.DISPlay.SP(1-1).ANNotation.MEASurement.STATe**

Syntax	SCPI.DISPlay.SP(1-1).ANNotation.MEASurement.STATe = <boolean> <boolean> = SCPI.DISPlay.SP(1-1).ANNotation.MEASurement.STATe
Description	Turns on/off measurement conditions
Variable	

	Param
True or -1(Preset value)	Show measurement conditions
False or 0	Hide measurement conditions

Equivalent key	SP Menu -> Display -> Meas Condition
----------------	--------------------------------------

**SCPI.DISPlay.SP(1-1).GRATicule.AXIS.Y.RELative**

Syntax	SCPI.DISPlay.SP(1-1).GRATicule.AXIS.Y.RELative = <boolean> <boolean> = SCPI.DISPlay.SP(1-1).GRATicule.AXIS.Y.RELative
--------	--

Description Turns on/off relative Y-scale

Variable

	Param
True or -1	Set relative Y-scale mode to 'ON'
False or 0(Preset value)	Set relative Y-scale mode to 'OFF'

Equivalent key SP Menu -> Display -> Relative Y-Scale

### **SCPI.DISPlay.SP(1-1).GRATicule.AXIS.Y.STATe**

Syntax SCPI.DISPlay.SP(1-1).GRATicule.AXIS.Y.STATe = <string>  
 <string> = SCPI.DISPlay.SP(1-1).GRATicule.AXIS.Y.STATe

Description Show/Hide Y graticule label

Variable

	Param
OFF	Hide Y graticule label
SHORT(Preset value)	Set Y graticule label to 'SHORT'
LONG	Set Y graticule label to 'LONG'

Equivalent key SP Menu -> Display -> Y # of Digits

### **SCPI.DISPlay.SP(1-1).LABel.DATA**

Syntax SCPI.DISPlay.SP(1-1).LABel.DATA = <string>  
 <string> = SCPI.DISPlay.SP(1-1).LABel.DATA

Description Edits window title label

Variable

	<String>
Range	-
Preset value	""
Unit	-
Resolution	-

Equivalent key SP Menu -> Display -> Edit Title Label

### **SCPI.DISPlay.SP(1-1).LABel.STATe**

Syntax SCPI.DISPlay.SP(1-1).LABel.STATe = <boolean>  
<boolean> = SCPI.DISPlay.SP(1-1).LABel.STATe

Description Show/Hide window title label

Variable

	<b>Param</b>
True or -1	Show window title label
False or 0(Preset value)	Hide window title label

Equivalent key SP Menu -> Display -> Title Label

### **SCPI.DISPlay.SP(1-1).LIMit.FSIGn**

Syntax SCPI.DISPlay.SP(1-1).LIMit.FSIGn = <boolean>  
<boolean> = SCPI.DISPlay.SP(1-1).LIMit.FSIGn

Description Turns on/off the limit test judgement display

Variable

	<b>Param</b>
True or -1(Preset value)	Turn on the limit test judgement display mode
False or 0	Turn off the limit test judgement display mode

Equivalent key SP Menu -> Display -> Limit Test -> Fail Sign

### **SCPI.DISPlay.SP(1-1).MAXimize**

Syntax SCPI.DISPlay.SP(1-1).MAXimize = <boolean>  
<boolean> = SCPI.DISPlay.SP(1-1).MAXimize

Description Maximize active trace

Variable

	<b>Param</b>
True or -1	Maximize active trace
False or 0(Preset value)	Restore all the traces

Equivalent key No equivalent key is available on the front panel.

### **SCPI.DISPlay.SP(1-1).STATE**

Syntax SCPI.DISPlay.SP(1-1).STATE = <boolean>  
 <boolean> = SCPI.DISPlay.SP(1-1).STATE

Description Turns on/off spectrum monitor mode

Variable

	<b>Param</b>
True or -1(Preset value)	Set spectrum monitor mode to 'ON'
False or 0	Set spectrum monitor mode to 'OFF'

Equivalent key PN Menu -> Measurement View -> Show Window -> Spectrum Monitor  
 SP Menu -> Measurement View -> Show Window -> Spectrum Monitor  
 FP Menu -> Measurement View -> Show Window -> Spectrum Monitor  
 TR Menu -> Measurement View -> Show Window -> Spectrum Monitor  
 USER Menu -> Measurement View -> Show Window -> Spectrum Monitor

### **SCPI.DISPlay.SP(1-1).TABLE.STATE**

Syntax SCPI.DISPlay.SP(1-1).TABLE.STATE = <boolean>  
 <boolean> = SCPI.DISPlay.SP(1-1).TABLE.STATE

Description Turns on/off the marker list

Variable

	<b>Param</b>
True or -1	Show the marker list
False or 0(Preset value)	Show the marker list

Equivalent key SP Menu -> Marker -> Marker List

### **SCPI.DISPlay.SP(1-1).TRACe(1-1).LABel.DATA**

Syntax SCPI.DISPlay.SP(1-1).TRACe(1-1).LABel.DATA = <string>  
<string> = SCPI.DISPlay.SP(1-1).TRACe(1-1).LABel.DATA

Description Sets/reads trace title label

Variable

	<b>&lt;String&gt;</b>
Range	-
Preset value	"Spectrum"
Unit	-
Resolution	-

Equivalent key SP Menu -> Trace View -> Trace Label

### **SCPI.DISPlay.SP(1-1).TRACe(1-1).LIMit.LINE**

Syntax SCPI.DISPlay.SP(1-1).TRACe(1-1).LIMit.LINE = <boolean>  
<boolean> = SCPI.DISPlay.SP(1-1).TRACe(1-1).LIMit.LINE

Description Turns on/off the limit line

Variable

	<b>Param</b>
True or -1 (Preset value)	Turn on the limit line mode
False or 0	Turn off the limit line mode

Equivalent key SP Menu -> Display -> Limit Test -> Limit Line

### **SCPI.DISPlay.SP(1-1).TRACe(1-1).MODE**

Syntax SCPI.DISPlay.SP(1-1).TRACe(1-1).MODE = <string>  
<string> = SCPI.DISPlay.SP(1-1).TRACe(1-1).MODE

Description Sets/reads data and/or memory trace

Variable

	Param
OFF	Hide data and memory trace
DATA(Preset value)	Show data trace
MEMory	Show memory trace
BOTH	Show both data and memory trace

Equivalent key SP Menu -> Trace View -> Display Trace

**SCPI.DISPlay.SP(1-1).TRACe(1-1).PERSistence.CLEAr**

Syntax SCPI.DISPlay.SP(1-1).TRACe(1-1).PERSistence.CLEAr

Description Clears persistent data (No Read)

Equivalent key SP Menu -> Trace View -> Persistence -> Clear Persistent Data

**SCPI.DISPlay.SP(1-1).TRACe(1-1).PERSistence.STATe**

Syntax SCPI.DISPlay.SP(1-1).TRACe(1-1).PERSistence.STATe = <boolean>  
 <boolean> = SCPI.DISPlay.SP(1-1).TRACe(1-1).PERSistence.STATe

Description Sets/reads persistence mode

Variable

	Param
True or -1	Set persistence mode to 'ON'
False or 0(Preset value)	Set persistence mode to 'OFF'

Equivalent key SP Menu -> Trace View -> Persistence -> Persistence Mode

**SCPI.DISPlay.SP(1-1).TRACe(1-1).Y.SCALe.AUTO**

Syntax SCPI.DISPlay.SP(1-1).TRACe(1-1).Y.SCALe.AUTO

Description Execute autoscale (No Read)

Equivalent key SP Menu -> Scale -> Auto Scale

## **SCPI.DISPlay.SP(1-1).TRACe(1-1).Y.SCALe.PDIVision**

Syntax SCPI.DISPlay.SP(1-1).TRACe(1-1).Y.SCALe.PDIVision = <double>  
<double> = SCPI.DISPlay.SP(1-1).TRACe(1-1).Y.SCALe.PDIVision

Description Sets/reads scale per division

Variable

	<b>&lt;Double&gt;</b>
Range	1a to 10G
Preset value	10
Unit	-
Resolution	-

Equivalent key SP Menu -> Scale -> Scale/Div

## **SCPI.DISPlay.SP(1-1).TRACe(1-1).Y.SCALe.RLEVel**

Syntax SCPI.DISPlay.SP(1-1).TRACe(1-1).Y.SCALe.RLEVel = <double>  
<double> = SCPI.DISPlay.SP(1-1).TRACe(1-1).Y.SCALe.RLEVel

Description Sets/reads scale reference level

Variable

	<b>&lt;Double&gt;</b>
Range	-50G to 50G
Preset value	10
Unit	-
Resolution	-

Equivalent key SP Menu -> Scale -> Reference Value  
SP Menu -> Scale -> Marker -> Reference

## **SCPI.DISPlay.SP(1-1).TRACe(1-1).Y.SCALe.RPOStion**

Syntax SCPI.DISPlay.SP(1-1).TRACe(1-1).Y.SCALe.RPOStion = <long>  
<long> = SCPI.DISPlay.SP(1-1).TRACe(1-1).Y.SCALe.RPOStion

Description Sets/reads scale reference position



Variable

	<Long>
Range	0 to 30
Preset value	10
Unit	Div
Resolution	-

Equivalent key SP Menu -> Scale -> Reference Position

**SCPI.DISPlay.SP(1-1).Y.SCALe.DIVisions**

Syntax SCPI.DISPlay.SP(1-1).Y.SCALe.DIVisions = <long>  
 <long> = SCPI.DISPlay.SP(1-1).Y.SCALe.DIVisions

Description Sets/reads teh number of Y division

Variable

	<Long>
Range	4 to 30
Preset value	10
Unit	-
Resolution	2

Equivalent key SP Menu -> Scale -> Divisions

**SCPI.DISPlay.TR(1-1).ALLTrace.PERSistence.CLEAr**

Syntax SCPI.DISPlay.TR(1-1).ALLTrace.PERSistence.CLEAr

Description Clear all persistent traces (No Read)

Equivalent key No equivalent key is available on the front panel.

**SCPI.DISPlay.TR(1-1).ALLTrace.Y.SCALe.AUTO**

Syntax SCPI.DISPlay.TR(1-1).ALLTrace.Y.SCALe.AUTO

Description Execute autoscale all (No Read)

Equivalent key TR Menu -> Scale -> Auto Scale All

## **SCPI.DISPlay.TR(1-1).ANNotation.MARKeR.POSition**

Syntax SCPI.DISPlay.TR(1-1).ANNotation.MARKeR.POSition = <string>  
<string> = SCPI.DISPlay.TR(1-1).ANNotation.MARKeR.POSition

Description Sets/reads the marker information position

Variable

	<b>Param</b>
LEFT(Preset value)	Set the marker information position to 'LEFT'
RIGHT	Set the marker information position to 'RIGHT'

Equivalent key TR Menu -> Display -> Marker Information

## **SCPI.DISPlay.TR(1-1).ANNotation.MEASurement.STATe**

Syntax SCPI.DISPlay.TR(1-1).ANNotation.MEASurement.STATe = <boolean>  
<boolean> = SCPI.DISPlay.TR(1-1).ANNotation.MEASurement.STATe

Description Turns on/off measurement conditions

Variable

	<b>Param</b>
True or -1(Preset value)	Show measurement conditions
False or 0	Hide measurement conditions

Equivalent key TR Menu -> Display -> Meas Condition

## **SCPI.DISPlay.TR(1-1).GRATicule.AXIS.Y.RELative**

Syntax SCPI.DISPlay.TR(1-1).GRATicule.AXIS.Y.RELative = <boolean>  
<boolean> = SCPI.DISPlay.TR(1-1).GRATicule.AXIS.Y.RELative

Description Sets/reads relative Y-scale

Variable

	<b>Param</b>
True or -1	Set relative Y-scale mode to 'ON'

	Param
False or 0(Preset value)	Set relative Y-scale mode to 'OFF'

Equivalent key TR Menu -> Display -> Relative Y-Scale

### **SCPI.DISPlay.TR(1-1).GRATicule.AXIS.Y.STATe**

Syntax SCPI.DISPlay.TR(1-1).GRATicule.AXIS.Y.STATe = <string>  
 <string> = SCPI.DISPlay.TR(1-1).GRATicule.AXIS.Y.STATe

Description Sets/reads the number of Y-digits

Variable

	Param
OFF	Set the number of Y-digits to 'OFF'
SHORT(Preset value)	Set the number of Y-digits to 'SHORT'
LONG	Set the number of Y-digits to 'LONG'

Equivalent key TR Menu -> Display -> Y # of Digits

### **SCPI.DISPlay.TR(1-1).LABel.DATA**

Syntax SCPI.DISPlay.TR(1-1).LABel.DATA = <string>  
 <string> = SCPI.DISPlay.TR(1-1).LABel.DATA

Description Edits window title label

Variable

	<String>
Range	-
Preset value	""
Unit	-
Resolution	-

Equivalent key TR Menu -> Display -> Edit Title Label

## **SCPI.DISPlay.TR(1-1).LABel.STATe**

Syntax SCPI.DISPlay.TR(1-1).LABel.STATe = <boolean>  
<boolean> = SCPI.DISPlay.TR(1-1).LABel.STATe

Description Turns on/off window title lable

Variable

	<b>Param</b>
True or -1	Set window title lable mode to 'ON'
False or 0(Preset value)	Set window title lable mode to 'OFF'

Equivalent key TR Menu -> Display -> Title Label

## **SCPI.DISPlay.TR(1-1).LIMit.FSIGn**

Syntax SCPI.DISPlay.TR(1-1).LIMit.FSIGn = <boolean>  
<boolean> = SCPI.DISPlay.TR(1-1).LIMit.FSIGn

Description Turns on/off the limit test judgement display

Variable

	<b>Param</b>
True or -1(Preset value)	Turn on the limit test judgement display mode
False or 0	Turn off the limit test judgement display mode

Equivalent key TR Menu -> Display -> Limit Test -> Fail Sign

## **SCPI.DISPlay.TR(1-1).MAXimize**

Syntax SCPI.DISPlay.TR(1-1).MAXimize = <boolean>  
<boolean> = SCPI.DISPlay.TR(1-1).MAXimize

Description Maximize active trace

Variable

	<b>Param</b>
True or -1	Maximize active trace

	Param
False or 0(Preset value)	Restore all the traces

Equivalent key No equivalent key is available on the front panel.

### **SCPI.DISPlay.TR(1-1).STaTe**

Syntax SCPI.DISPlay.TR(1-1).STaTe = <boolean>  
 <boolean> = SCPI.DISPlay.TR(1-1).STaTe

Description Turns on/off transient measurement mode

Variable

	Param
True or -1(Preset value)	Set transient measurement mode to 'ON'
False or 0	Set transient measurement mode to 'OFF'

Equivalent key PN Menu -> Measurement View -> Show Window -> Transient  
 SP Menu -> Measurement View -> Show Window -> Transient  
 FP Menu -> Measurement View -> Show Window -> Transient  
 TR Menu -> Measurement View -> Show Window -> Transient  
 USER Menu -> Measurement View -> Show Window -> Transient

### **SCPI.DISPlay.TR(1-1).TABLE.STaTe**

Syntax SCPI.DISPlay.TR(1-1).TABLE.STaTe = <boolean>  
 <boolean> = SCPI.DISPlay.TR(1-1).TABLE.STaTe

Description Turns on/off the marker list

Variable

	Param
True or -1	Show marker list
False or 0(Preset value)	Hide marker list

Equivalent key TR Menu -> Marker -> Marker List

## **SCPI.DISPlay.TR(1-1).TRACe(1-4).LABel.DATA**

Syntax SCPI.DISPlay.TR(1-1).TRACe(1-4).LABel.DATA = <string>  
<string> = SCPI.DISPlay.TR(1-1).TRACe(1-4).LABel.DATA

Description Sets/reads the trace title label

Variable

	<b>&lt;String&gt;</b>
Range	-
Preset value	"WB Freq"
Unit	-
Resolution	-

Equivalent key TR Menu -> Trace View -> Trace Label

## **SCPI.DISPlay.TR(1-1).TRACe(1-4).LIMit.LINE**

Syntax SCPI.DISPlay.TR(1-1).TRACe(1-4).LIMit.LINE = <boolean>  
<boolean> = SCPI.DISPlay.TR(1-1).TRACe(1-4).LIMit.LINE

Description Turns on/off the limit line

Variable

	<b>Param</b>
True or -1(Preset value)	Turn on the limit line mode
False or 0	Turn off the limit line mode

Equivalent key TR Menu -> Display -> Limit Test -> Limit Line

## **SCPI.DISPlay.TR(1-1).TRACe(1-4).MODE**

Syntax SCPI.DISPlay.TR(1-1).TRACe(1-4).MODE = <string>  
<string> = SCPI.DISPlay.TR(1-1).TRACe(1-4).MODE

Description show data and/or memory trace

Variable

	Param
OFF	Hide data and memory trace
DATA(Preset value)	Show data trace only
MEMory	Show memory trace only
BOTH	Show both data and memory traces

Equivalent key TR Menu -> Trace View -> Display Trace

**SCPI.DISPlay.TR(1-1).TRACe(1-4).PERSistence.CLEAr**

Syntax SCPI.DISPlay.TR(1-1).TRACe(1-4).PERSistence.CLEAr

Description Clears persistent data (No Read)

Equivalent key TR Menu -> Trace View -> Persistence -> Clear Persistent Data

**SCPI.DISPlay.TR(1-1).TRACe(1-4).PERSistence.STATe**

Syntax SCPI.DISPlay.TR(1-1).TRACe(1-4).PERSistence.STATe = <boolean>  
 <boolean> = SCPI.DISPlay.TR(1-1).TRACe(1-4).PERSistence.STATe

Description Sets/reads persistence mode

Variable

	Param
True or -1	Set persistence mode to 'ON'
False or 0(Preset value)	Set persistence mode to 'OFF'

Equivalent key TR Menu -> Trace View -> Persistence -> Persistence Mode

**SCPI.DISPlay.TR(1-1).TRACe(1-4).Y.SCALe.AUTO**

Syntax SCPI.DISPlay.TR(1-1).TRACe(1-4).Y.SCALe.AUTO

Description Execute autoscale (No Read)

Equivalent key TR Menu -> Scale -> Auto Scale

## **SCPI.DISPlay.TR(1-1).TRACe(1-4).Y.SCALe.PDIVision**

Syntax SCPI.DISPlay.TR(1-1).TRACe(1-4).Y.SCALe.PDIVision = <double>  
<double> = SCPI.DISPlay.TR(1-1).TRACe(1-4).Y.SCALe.PDIVision

Description scale per division

Variable

	<b>&lt;Double&gt;</b>
Range	1a to 10G
Preset value	80M
Unit	-
Resolution	-

Equivalent key TR Menu -> Scale -> Scale/Div

## **SCPI.DISPlay.TR(1-1).TRACe(1-4).Y.SCALe.RLEVel**

Syntax SCPI.DISPlay.TR(1-1).TRACe(1-4).Y.SCALe.RLEVel = <double>  
<double> = SCPI.DISPlay.TR(1-1).TRACe(1-4).Y.SCALe.RLEVel

Description scale reference level

Variable

	<b>&lt;Double&gt;</b>
Range	-50G to 50G
Preset value	800M
Unit	-
Resolution	-

Equivalent key TR Menu -> Scale -> Reference Value  
TR Menu -> Scale -> Marker -> Reference

## **SCPI.DISPlay.TR(1-1).TRACe(1-4).Y.SCALe.RPOSITION**

Syntax SCPI.DISPlay.TR(1-1).TRACe(1-4).Y.SCALe.RPOSITION = <long>  
<long> = SCPI.DISPlay.TR(1-1).TRACe(1-4).Y.SCALe.RPOSITION

Description scale reference position



Variable

	<Long>
Range	0 to 30
Preset value	5
Unit	Div
Resolution	-

Equivalent key TR Menu -> Scale -> Reference Position

**SCPI.DISPlay.TR(1-1).Y.SCALe.DIVisions**

Syntax SCPI.DISPlay.TR(1-1).Y.SCALe.DIVisions = <long>  
 <long> = SCPI.DISPlay.TR(1-1).Y.SCALe.DIVisions

Description # of Y division

Variable

	<Long>
Range	4 to 30
Preset value	10
Unit	-
Resolution	2

Equivalent key TR Menu -> Scale -> Divisions

**SCPI.DISPlay.UPDate.IMMediate**

Syntax SCPI.DISPlay.UPDate.IMMediate

Description Update display force (No Read)

Equivalent key No equivalent key is available on the front panel.

**SCPI.DISPlay.USER(1-1).ALLTrace.PERSistence.CLEAr**

Syntax SCPI.DISPlay.USER(1-1).ALLTrace.PERSistence.CLEAr

Description clear all stored traces (No Read)

Equivalent key USER Menu -> Trace View -> Persistence -> Clear All Persistent Data

## **SCPI.DISPlay.USER(1-1).ALLTrace.Y.SCALe.AUTO**

Syntax SCPI.DISPlay.USER(1-1).ALLTrace.Y.SCALe.AUTO

Description auto scale all (No Read)

Equivalent key USER Menu -> Scale -> Auto Scale All

## **SCPI.DISPlay.USER(1-1).ANNotation.MARKer.POSition**

Syntax SCPI.DISPlay.USER(1-1).ANNotation.MARKer.POSition = <string>  
<string> = SCPI.DISPlay.USER(1-1).ANNotation.MARKer.POSition

Description Sets/reads the marker information position

Variable

	<b>Param</b>
LEFT(Preset value)	Set the marker information position to 'LEFT'
RIGHt	Set the marker information position to 'RIGHT'

Equivalent key USER Menu -> Display -> Marker Information

## **SCPI.DISPlay.USER(1-1).ANNotation.MEASurement.STATe**

Syntax SCPI.DISPlay.USER(1-1).ANNotation.MEASurement.STATe = <boolean>  
<boolean> = SCPI.DISPlay.USER(1-1).ANNotation.MEASurement.STATe

Description Turns on/off measurement conditions

Variable

	<b>Param</b>
True or -1(Preset value)	Show measurement conditions
False or 0	Hide measurement conditions

Equivalent key USER Menu -> Display -> Meas Condition

## **SCPI.DISPlay.USER(1-1).GRATicule.AXIS.Y.RELative**

Syntax SCPI.DISPlay.USER(1-1).GRATicule.AXIS.Y.RELative = <boolean>  
<boolean> = SCPI.DISPlay.USER(1-1).GRATicule.AXIS.Y.RELative

Description Sets/reads the relative Y-label

Variable

	Param
True or -1	Set relative Y-axis label to 'ON'
False or 0(Preset value)	Set relative Y-axis label to 'OFF'

Equivalent key USER Menu -> Display -> Relative Y-Scale

### **SCPI.DISPlay.USER(1-1).GRATicule.AXIS.Y.STATe**

Syntax SCPI.DISPlay.USER(1-1).GRATicule.AXIS.Y.STATe = <string>  
 <string> = SCPI.DISPlay.USER(1-1).GRATicule.AXIS.Y.STATe

Description Show/Hide Y graticule label

Variable

	Param
OFF	Hide Y graticule label to 'OFF'
SHORT(Preset value)	Set Y graticule label to 'SHORT'
LONG	Set Y graticule label to 'LONG'

Equivalent key USER Menu -> Display -> Y # of Digits

### **SCPI.DISPlay.USER(1-1).LABel.DATA**

Syntax SCPI.DISPlay.USER(1-1).LABel.DATA = <string>  
 <string> = SCPI.DISPlay.USER(1-1).LABel.DATA

Description Sets/reads window title label

Variable

	<String>
Range	-
Preset value	""
Unit	-
Resolution	-

Equivalent key USER Menu -> Display -> Edit Title Label

### **SCPI.DISPlay.USER(1-1).LABel.STATe**

Syntax SCPI.DISPlay.USER(1-1).LABel.STATe = <boolean>  
<boolean> = SCPI.DISPlay.USER(1-1).LABel.STATe

Description Show/Hide window title label

Variable

	<b>Param</b>
True or -1	Show window title label
False or 0(Preset value)	Hide window title label

Equivalent key USER Menu -> Display -> Title Label

### **SCPI.DISPlay.USER(1-1).LIMit.FSIGn**

Syntax SCPI.DISPlay.USER(1-1).LIMit.FSIGn = <boolean>  
<boolean> = SCPI.DISPlay.USER(1-1).LIMit.FSIGn

Description Turns on/off the limit test judgement display

Variable

	<b>Param</b>
True or -1(Preset value)	Turn on the limit test judgement display mode
False or 0	Turn off the limit test judgement display mode

Equivalent key USER Menu -> Display -> Limit Test -> Fail Sign

### **SCPI.DISPlay.USER(1-1).MAXimize**

Syntax SCPI.DISPlay.USER(1-1).MAXimize = <boolean>  
<boolean> = SCPI.DISPlay.USER(1-1).MAXimize

Description Maximize active trace

Variable

	Param
True or -1	Maximize active trace
False or 0(Preset value)	Restore all the traces

Equivalent key No equivalent key is available on the front panel.

**SCPI.DISPlay.USER(1-1).STATE**

Syntax SCPI.DISPlay.USER(1-1).STATE = <boolean>  
 <boolean> = SCPI.DISPlay.USER(1-1).STATE

Description Turns on/off user defined window

Variable

	Param
True or -1	Show user defined window
False or 0(Preset value)	Hide user defined window

Equivalent key PN Menu -> Measurement View -> Show Window -> User  
 SP Menu -> Measurement View -> Show Window -> User  
 FP Menu -> Measurement View -> Show Window -> User  
 TR Menu -> Measurement View -> Show Window -> User  
 USER Menu -> Measurement View -> Show Window -> User

**SCPI.DISPlay.USER(1-1).TABLE.STATE**

Syntax SCPI.DISPlay.USER(1-1).TABLE.STATE = <boolean>  
 <boolean> = SCPI.DISPlay.USER(1-1).TABLE.STATE

Description Turns on/off the marker list

Variable

	Param
True or -1	Show the marker list
False or 0(Preset value)	Hide the marker list

Equivalent key USER Menu -> Marker -> Marker List

### **SCPI.DISPlay.USER(1-1).TRACe(1-8).LABel.DATA**

Syntax SCPI.DISPlay.USER(1-1).TRACe(1-8).LABel.DATA = <string>  
<string> = SCPI.DISPlay.USER(1-1).TRACe(1-8).LABel.DATA

Description Sets/reads trace title label

Variable

	<b>&lt;String&gt;</b>
Range	-
Preset value	"Tr1"
Unit	-
Resolution	-

Equivalent key USER Menu -> Trace View -> Trace Label

### **SCPI.DISPlay.USER(1-1).TRACe(1-8).LIMit.LINE**

Syntax SCPI.DISPlay.USER(1-1).TRACe(1-8).LIMit.LINE = <boolean>  
<boolean> = SCPI.DISPlay.USER(1-1).TRACe(1-8).LIMit.LINE

Description Turns on/off the limit line

Variable

	<b>Param</b>
True or -1 (Preset value)	Turn on the limit line mode
False or 0	Turn off the limit line mode

Equivalent key USER Menu -> Display -> Limit Test -> Limit Line

### **SCPI.DISPlay.USER(1-1).TRACe(1-8).MODE**

Syntax SCPI.DISPlay.USER(1-1).TRACe(1-8).MODE = <string>  
<string> = SCPI.DISPlay.USER(1-1).TRACe(1-8).MODE

Description Turns on/off data and/or memory trace

Variable

	Param
OFF	Hide data and memory trace
DATA(Preset value)	Show data trace only
MEMory	Show memory trace only
BOTH	Show both data and memory trace

Equivalent key USER Menu -&gt; Trace View -&gt; Display Trace

**SCPI.DISPlay.USER(1-1).TRACe(1-8).PERSistence.STATe**

Syntax

SCPI.DISPlay.USER(1-1).TRACe(1-8).PERSistence.STATe = &lt;boolean&gt;

&lt;boolean&gt; = SCPI.DISPlay.USER(1-1).TRACe(1-8).PERSistence.STATe

Description

Clears persistent data

Variable

	Param
True or -1	Set Clears persistent data mode to 'ON'
False or 0(Preset value)	Set Clears persistent data mode to 'OFF'

Equivalent key

USER Menu -&gt; Trace View -&gt; Persistence -&gt; Persistence Mode

**SCPI.DISPlay.USER(1-1).TRACe(1-8).STATe**

Syntax

SCPI.DISPlay.USER(1-1).TRACe(1-8).STATe = &lt;boolean&gt;

&lt;boolean&gt; = SCPI.DISPlay.USER(1-1).TRACe(1-8).STATe

Description

Sets/reads persistence mode

Variable

	Param
True or -1(Preset value)	Set persistence mode to 'ON'
False or 0	Set persistence mode to 'OFF'

Equivalent key

USER Menu -&gt; Trace View -&gt; Enable Trace -&gt; Trace 1

**SCPI.DISPlay.USER(1-1).TRACe(1-8).X.TYPE**

Syntax SCPI.DISPlay.USER(1-1).TRACe(1-8).X.TYPE = <string>  
 <string> = SCPI.DISPlay.USER(1-1).TRACe(1-8).X.TYPE

Description Sets/reads the display type of the x axis.

Variable

	Param
LINear(Preset value)	Set the display type of the x axis. to 'Linear'
LOGarithmic	Set the display type of the x axis. to 'Logarithmic'

Equivalent key USER Menu -> Scale -> X Axis Type

**SCPI.DISPlay.USER(1-1).TRACe(1-8).X.UNIT**

Syntax SCPI.DISPlay.USER(1-1).TRACe(1-8).X.UNIT = <string>  
 <string> = SCPI.DISPlay.USER(1-1).TRACe(1-8).X.UNIT

Description Sets/reads X-axis unit

Variable

	<String>
Range	-
Preset value	"U"
Unit	-
Resolution	-

Equivalent key USER Menu -> Scale -> X Unit

**SCPI.DISPlay.USER(1-1).TRACe(1-8).Y.SCALe.AUTO**

Syntax SCPI.DISPlay.USER(1-1).TRACe(1-8).Y.SCALe.AUTO

Description Execute autoscale (No Read)

Equivalent key USER Menu -> Scale -> Auto Scale

**SCPI.DISPlay.USER(1-1).TRACe(1-8).Y.SCALe.PDIVision**

Syntax SCPI.DISPlay.USER(1-1).TRACe(1-8).Y.SCALe.PDIVision = <double>



<double> = SCPI.DISPlay.USER(1-1).TRACe(1-8).Y.SCALe.PDIVision

Description Sets/reads scale per division

Variable

	<b>&lt;Double&gt;</b>
Range	1a to 10G
Preset value	10
Unit	-
Resolution	-

Equivalent key USER Menu -> Scale -> Scale/Div

### **SCPI.DISPlay.USER(1-1).TRACe(1-8).Y.SCALe.RLEVel**

Syntax SCPI.DISPlay.USER(1-1).TRACe(1-8).Y.SCALe.RLEVel = <double>

<double> = SCPI.DISPlay.USER(1-1).TRACe(1-8).Y.SCALe.RLEVel

Description Sets/reads the scale reference level

Variable

	<b>&lt;Double&gt;</b>
Range	-50G to 50G
Preset value	-40
Unit	-
Resolution	-

Equivalent key USER Menu -> Scale -> Reference Value

USER Menu -> Scale -> Marker -> Reference

### **SCPI.DISPlay.USER(1-1).TRACe(1-8).Y.SCALe.RPOStion**

Syntax SCPI.DISPlay.USER(1-1).TRACe(1-8).Y.SCALe.RPOStion = <long>

<long> = SCPI.DISPlay.USER(1-1).TRACe(1-8).Y.SCALe.RPOStion

Description Sets/reads the scale reference position

Variable

	<b>&lt;Long&gt;</b>
Range	0 to 30
Preset value	5
Unit	Div
Resolution	-

Equivalent key USER Menu -> Scale -> Reference Position

### **SCPI.DISPlay.USER(1-1).TRACe(1-8).Y.UNIT**

Syntax SCPI.DISPlay.USER(1-1).TRACe(1-8).Y.UNIT = <string>  
<string> = SCPI.DISPlay.USER(1-1).TRACe(1-8).Y.UNIT

Description Sets/reads the Y-axis unit

Variable

	<b>&lt;String&gt;</b>
Range	-
Preset value	"U"
Unit	-
Resolution	-

Equivalent key USER Menu -> Scale -> Y Unit

### **SCPI.DISPlay.USER(1-1).Y.SCALe.DIVisions**

Syntax SCPI.DISPlay.USER(1-1).Y.SCALe.DIVisions = <long>  
<long> = SCPI.DISPlay.USER(1-1).Y.SCALe.DIVisions

Description Sets/reads the number of Y division

Variable

	<b>&lt;Long&gt;</b>
Range	4 to 30
Preset value	10
Unit	-

	<Long>
Resolution	2

Equivalent key USER Menu -> Scale -> Divisions

### **SCPI.DISPlay.WINDow.ACTive**

Syntax SCPI.DISPlay.WINDow.ACTive = <string>  
 <string> = SCPI.DISPlay.WINDow.ACTive

Description Selects the active measurement window

Variable

	Param
PN1(Preset value)	Set active measurement window to 'PN1'
SP1	Set active measurement window to 'SP1'
FP1	Set active measurement window to 'FP1'
TR1	Set active measurement window to 'TR1'
USER1	Set active measurement window to 'USER1'

Equivalent key PN Menu -> Measurement View -> Phase Noise  
 PN Menu -> Measurement View -> Spectrum Monitor  
 PN Menu -> Measurement View -> Freq & Power  
 PN Menu -> Measurement View -> Transient  
 PN Menu -> Measurement View -> User  
 SP Menu -> Measurement View -> Phase Noise

### **SCPI.FORMat.BORDER**

Syntax SCPI.FORMat.BORDER = <string>  
 <string> = SCPI.FORMat.BORDER

Description Sets/reads byte order setting for binary transfer

Variable

	<b>Param</b>
NORMal(Preset value)	Set byte order setting for binary transfer to 'NORMal'
SWAPped	Set byte order setting for binary transfer to 'SWAPped'

Equivalent key No equivalent key is available on the front panel.

## **SCPI.FORMat.DATA**

Syntax SCPI.FORMat.DATA = <string>  
<string> = SCPI.FORMat.DATA

Description Sets/reads data transfer mode

Variable

	<b>Param</b>
ASCii(Preset value)	Set data transfer mode to 'ASCii'
REAL32	Set data transfer mode to 'REAL32'
REAL64	Set data transfer mode to 'REAL64'

Equivalent key No equivalent key is available on the front panel.

## **SCPI.HCOPy.ABORt**

Syntax SCPI.HCOPy.ABORt

Description Aborts printing (No Read)

Equivalent key PN Menu -> System -> Abort Printing  
SP Menu -> System -> Abort Printing  
FP Menu -> System -> Abort Printing  
TR Menu -> System -> Abort Printing  
USER Menu -> System -> Abort Printing

## **SCPI.HCOPy.IMAGe**

Syntax SCPI.HCOPy.IMAGe = <string>  
<string> = SCPI.HCOPy.IMAGe

Description Selects print mode

Variable

	Param
NORMAL(Preset value)	Set print mode to 'NORMAL'
INVert	Set print mode to 'INVert'

Equivalent key  
 PN Menu -> System -> Invert Image  
 SP Menu -> System -> Invert Image  
 FP Menu -> System -> Invert Image  
 TR Menu -> System -> Invert Image  
 USER Menu -> System -> Invert Image

### **SCPI.HCOPy.IMMediate**

Syntax SCPI.HCOPy.IMMediate

Description Outputs print (No Read)

Equivalent key No equivalent key is available on the front panel.

### **SCPI.IEEE4882.CLS**

Syntax SCPI.IEEE4882.CLS

Description Clears registers (No Read)

Equivalent key No equivalent key is available on the front panel.

### **SCPI.IEEE4882.ESE**

Syntax  
 SCPI.IEEE4882.ESE = <long>  
 <long> = SCPI.IEEE4882.ESE

Description Sets/reads standard event status enable register

Variable

	<Long>
Range	0 to 255
Preset value	0
Unit	-

	<Long>
Resolution	-

Equivalent key No equivalent key is available on the front panel.

### **SCPI.IEEE4882.ESR**

Syntax <long> = SCPI.IEEE4882.ESR

Description Reads standard event status register value (Read Only)

Equivalent key No equivalent key is available on the front panel.

### **SCPI.IEEE4882.IDN**

Syntax <string> = SCPI.IEEE4882.IDN

Description Reads product model information (Read Only)

Equivalent key No equivalent key is available on the front panel.

### **SCPI.IEEE4882.OPC**

Syntax SCPI.IEEE4882.OPC = <long>  
<long> = SCPI.IEEE4882.OPC

Description Sets OPC bit on operation termination

Variable

	<Long>
Range	-
Preset value	1
Unit	-
Resolution	-

Equivalent key No equivalent key is available on the front panel.

### **SCPI.IEEE4882.OPT**

Syntax <string> = SCPI.IEEE4882.OPT

Description Reads option information (Read Only)

Equivalent key No equivalent key is available on the front panel.

### **SCPI.IEEE4882.RST**

Syntax SCPI.IEEE4882.RST

Description Preset (No Read)

Equivalent key No equivalent key is available on the front panel.

### **SCPI.IEEE4882.SRE**

Syntax SCPI.IEEE4882.SRE = <long>  
 <long> = SCPI.IEEE4882.SRE

Description Sets service request enable register

Variable

	<Long>
Range	0 to 255
Preset value	0
Unit	-
Resolution	-

Equivalent key No equivalent key is available on the front panel.

### **SCPI.IEEE4882.STB**

Syntax <long> = SCPI.IEEE4882.STB

Description Reads status byte register (Read Only)

Equivalent key No equivalent key is available on the front panel.

### **SCPI.IEEE4882.TRG**

Syntax SCPI.IEEE4882.TRG

Description BUS Trigger (No Read)

Equivalent key No equivalent key is available on the front panel.

### **SCPI.INITiate.FP(1-1).CONTInuous**

Syntax SCPI.INITiate.FP(1-1).CONTInuous = <boolean>  
 <boolean> = SCPI.INITiate.FP(1-1).CONTInuous

Description Sets/reads trigger continuous mode

Variable

	<b>Param</b>
True or -1	Set trigger continuous mode to 'ON'
False or 0(Preset value)	Set trigger continuous mode to 'OFF'

Equivalent key No equivalent key is available on the front panel.

### **SCPI.INITiate.FP(1-1).IMMEDIATE**

Syntax SCPI.INITiate.FP(1-1).IMMEDIATE

Description Trigger once then 'HOLD' (No Read)

Equivalent key No equivalent key is available on the front panel.

### **SCPI.INITiate.PN(1-1).CONTinuous**

Syntax SCPI.INITiate.PN(1-1).CONTinuous = <boolean>  
<boolean> = SCPI.INITiate.PN(1-1).CONTinuous

Description Sets/reads trigger continuous mode

Variable

	<b>Param</b>
True or -1	Set trigger continuous mode to 'ON'
False or 0(Preset value)	Set trigger continuous mode to 'OFF'

Equivalent key No equivalent key is available on the front panel.

### **SCPI.INITiate.PN(1-1).IMMEDIATE**

Syntax SCPI.INITiate.PN(1-1).IMMEDIATE

Description Trigger once then 'HOLD' (No Read)

Equivalent key No equivalent key is available on the front panel.

### **SCPI.INITiate.SP(1-1).CONTinuous**

Syntax SCPI.INITiate.SP(1-1).CONTinuous = <boolean>



<boolean> = SCPI.INITiate.SP(1-1).CONTinuous

Description Sets/reads trigger continuous mode

Variable

	Param
True or -1	Set trigger continuous mode to 'ON'
False or 0(Preset value)	Set trigger continuous mode to 'OFF'

Equivalent key No equivalent key is available on the front panel.

**SCPI.INITiate.SP(1-1).IMMediate**

Syntax SCPI.INITiate.SP(1-1).IMMediate

Description Trigger once then 'HOLD' (No Read)

Equivalent key No equivalent key is available on the front panel.

**SCPI.INITiate.TR(1-1).CONTinuous**

Syntax SCPI.INITiate.TR(1-1).CONTinuous = <boolean>  
 <boolean> = SCPI.INITiate.TR(1-1).CONTinuous

Description Sets/reads trigger continuous mode

Variable

	Param
True or -1	Set trigger continuous mode to 'ON'
False or 0(Preset value)	Set trigger continuous mode to 'OFF'

Equivalent key No equivalent key is available on the front panel.

**SCPI.INITiate.TR(1-1).IMMediate**

Syntax SCPI.INITiate.TR(1-1).IMMediate

Description Trigger once, then 'HOLD' (No Read)

Equivalent key No equivalent key is available on the front panel.

## SCPI.MMEMory.CATalog\_Q dir, list

Syntax	SCPI.MMEMory.CATalog_Q dir, list
Description	Catalog directory. (Read Only)
Examples	<pre>Dim dir As String Dim list As String  SCPI.MMEMory.CATalog_Q dir, list</pre>
Equivalent key	No equivalent key is available on the front panel.

## SCPI.MMEMory.COPY src, dst

Syntax	SCPI.MMEMory.COPY src, dst
Description	Copy file (No Read)
Variable	

	<String 1>
Range	-
Preset value	-
Unit	-
Resolution	-

	<String 2>
Range	-
Preset value	-
Unit	-
Resolution	-

Equivalent key	No equivalent key is available on the front panel.
----------------	--

## SCPI.MMEMory.DATA[\_Q] file, data

Syntax	SCPI.MMEMory.DATA[_Q] file, data
Description	Transfer a file through SCPI

Variable

	<String 1>
Range	-
Preset value	-
Unit	-
Resolution	-

	<Variant >
Range	-
Preset value	-
Unit	-
Resolution	-

Equivalent key No equivalent key is available on the front panel.

### **SCPI.MMEMory.DElete**

Syntax SCPI.MMEMory.DElete

Description Delete file/directory (No Read)

Variable

	<String>
Range	-
Preset value	-
Unit	-
Resolution	-

Equivalent key No equivalent key is available on the front panel.

### **SCPI.MMEMory.FP(1-1).TRACe(1-4).LOAD.LIMit.LOWer**

Syntax SCPI.MMEMory.FP(1-1).TRACe(1-4).LOAD.LIMit.LOWer

Description Reads the lower limit line (No Query)

Variable

	<b>&lt;String&gt;</b>
Range	-
Preset value	-
Unit	-
Resolution	-

Equivalent key

FP Menu -> Display -> Limit Test -> Import Lower Limit Line...

**SCPI.MMEMory.FP(1-1).TRACe(1-4).LOAD.LIMit.UPPer**

Syntax

SCPI.MMEMory.FP(1-1).TRACe(1-4).LOAD.LIMit.UPPer

Description

Reads the upper limit line (No Query)

Variable

	<b>&lt;String&gt;</b>
Range	-
Preset value	-
Unit	-
Resolution	-

Equivalent key

FP Menu -> Display -> Limit Test -> Import Upper Limit Line...

**SCPI.MMEMory.FP(1-1).TRACe(1-4).STORE.DATA**

Syntax

SCPI.MMEMory.FP(1-1).TRACe(1-4).STORE.DATA

Description

Saves trace data (No Read)

Variable

	<b>&lt;String&gt;</b>
Range	-
Preset value	-
Unit	-
Resolution	-

Equivalent key

No equivalent key is available on the front panel.

### **SCPI.MMEMory.FP(1-1).TRACe(1-4).STORE.MEMory**

Syntax SCPI.MMEMory.FP(1-1).TRACe(1-4).STORE.MEMory

Description Saves memory trace data (No Read)

Variable

	<String>
Range	-
Preset value	-
Unit	-
Resolution	-

Equivalent key No equivalent key is available on the front panel.

### **SCPI.MMEMory.LOAD.PROGram**

Syntax SCPI.MMEMory.LOAD.PROGram

Description Loads program (No Read)

Variable

	<String>
Range	-
Preset value	-
Unit	-
Resolution	-

Equivalent key No equivalent key is available on the front panel.

### **SCPI.MMEMory.LOAD.STATe**

Syntax SCPI.MMEMory.LOAD.STATe

Description Recalls settings (No Read)

Variable

	<String>
Range	-

	<String>
Preset value	-
Unit	-
Resolution	-

Equivalent key No equivalent key is available on the front panel.

### **SCPI.MMEMory.MDIRectory**

Syntax SCPI.MMEMory.MDIRectory

Description Creates a directory (No Read)

Variable

	<String>
Range	-
Preset value	-
Unit	-
Resolution	-

Equivalent key No equivalent key is available on the front panel.

### **SCPI.MMEMory.PN(1-1).TRACe(1-1).LOAD.LIMit.LOWer**

Syntax SCPI.MMEMory.PN(1-1).TRACe(1-1).LOAD.LIMit.LOWer

Description Reads the lower limit line (No Query)

Variable

	<String>
Range	-
Preset value	-
Unit	-
Resolution	-

Equivalent key PN Menu -> Display -> Limit Test -> Import Lower Limit Line...

## **SCPI.MMEMory.PN(1-1).TRACe(1-1).LOAD.LIMit.UPPer**

Syntax SCPI.MMEMory.PN(1-1).TRACe(1-1).LOAD.LIMit.UPPer

Description Reads the upper limit line (No Query)

Variable

	<String>
Range	-
Preset value	-
Unit	-
Resolution	-

Equivalent key PN Menu -> Display -> Limit Test -> Import Upper Limit Line...

## **SCPI.MMEMory.PN(1-1).TRACe(1-1).LOAD.SPURious.THReshold**

Syntax SCPI.MMEMory.PN(1-1).TRACe(1-1).LOAD.SPURious.THReshold

Description Reads the threshold data (No Query)

Variable

	<String>
Range	-
Preset value	-
Unit	-
Resolution	-

Equivalent key PN Menu -> Trace View -> Spurious -> Import Threshold Table...

## **SCPI.MMEMory.PN(1-1).TRACe(1-1).STORE.DATA**

Syntax SCPI.MMEMory.PN(1-1).TRACe(1-1).STORE.DATA

Description Saves trace data (No Read)

Variable

	<String>
Range	-

COM Object Reference  
**SCPI.MMEMory.PN(1-1).TRACe(1-1).STORE.MEMory**

	<String>
Preset value	-
Unit	-
Resolution	-

Equivalent key No equivalent key is available on the front panel.

**SCPI.MMEMory.PN(1-1).TRACe(1-1).STORE.MEMory**

Syntax SCPI.MMEMory.PN(1-1).TRACe(1-1).STORE.MEMory

Description Saves memory trace data (No Read)

Variable

	<String>
Range	-
Preset value	-
Unit	-
Resolution	-

Equivalent key No equivalent key is available on the front panel.

**SCPI.MMEMory.SP(1-1).TRACe(1-1).LOAD.LIMit.LOWer**

Syntax SCPI.MMEMory.SP(1-1).TRACe(1-1).LOAD.LIMit.LOWer

Description Reads the lower limit line (No Query)

Variable

	<String>
Range	-
Preset value	-
Unit	-
Resolution	-

Equivalent key SP Menu -> Display -> Limit Test -> Import Lower Limit Line...



## **SCPI.MMEMory.SP(1-1).TRACe(1-1).LOAD.LIMit.UPPer**

Syntax SCPI.MMEMory.SP(1-1).TRACe(1-1).LOAD.LIMit.UPPer

Description Reads the upper limit line (No Query)

Variable

	<String>
Range	-
Preset value	-
Unit	-
Resolution	-

Equivalent key SP Menu -> Display -> Limit Test -> Import Upper Limit Line...

## **SCPI.MMEMory.SP(1-1).TRACe(1-1).STORE.DATA**

Syntax SCPI.MMEMory.SP(1-1).TRACe(1-1).STORE.DATA

Description Saves trace data (No Read)

Variable

	<String>
Range	-
Preset value	-
Unit	-
Resolution	-

Equivalent key No equivalent key is available on the front panel.

## **SCPI.MMEMory.SP(1-1).TRACe(1-1).STORE.MEMory**

Syntax SCPI.MMEMory.SP(1-1).TRACe(1-1).STORE.MEMory

Description Saves memory trace data (No Read)

Variable

	<String>
Range	-

COM Object Reference  
**SCPI.MMEMory.STORe.IMAGE**

	<String>
Preset value	-
Unit	-
Resolution	-

Equivalent key No equivalent key is available on the front panel.

**SCPI.MMEMory.STORe.IMAGE**

Syntax SCPI.MMEMory.STORe.IMAGE

Description Save screen image (No Read)

Variable

	<String>
Range	-
Preset value	-
Unit	-
Resolution	-

Equivalent key No equivalent key is available on the front panel.

**SCPI.MMEMory.STORe.PROGram**

Syntax SCPI.MMEMory.STORe.PROGram

Description Save VBA project (No Read)

Variable

	<String>
Range	-
Preset value	-
Unit	-
Resolution	-

Equivalent key No equivalent key is available on the front panel.

## SCPI.MMEMory.STORe.STATe

Syntax SCPI.MMEMory.STORe.STATe

Description Save settings (No Read)

Variable

	<String>
Range	-
Preset value	-
Unit	-
Resolution	-

Equivalent key No equivalent key is available on the front panel.

## SCPI.MMEMory.STORe.STYPe

Syntax SCPI.MMEMory.STORe.STYPe = <string>

<string> = SCPI.MMEMory.STORe.STYPe

Description Select save state type

Variable

	Param
STATe(Preset value)	Set save state type to 'STATe' (instrument's state only)
DState	Set save state type to 'DState' (instrument state and data, memory trace)

Equivalent key  
 PN Menu -> Save/Recall -> Save State -> Save Type  
 SP Menu -> Save/Recall -> Save State -> Save Type  
 FP Menu -> Save/Recall -> Save State -> Save Type  
 TR Menu -> Save/Recall -> Save State -> Save Type  
 USER Menu -> Save/Recall -> Save State -> Save Type

## SCPI.MMEMory.TR(1-1).TRACe(1-4).LOAD.LIMit.LOWe **r**

Syntax SCPI.MMEMory.TR(1-1).TRACe(1-4).LOAD.LIMit.LOWer

Description Reads the lower limit line (No Query)

Variable

	<b>&lt;String&gt;</b>
Range	-
Preset value	-
Unit	-
Resolution	-

Equivalent key

TR Menu -> Display -> Limit Test -> Import Lower Limit Line...

**SCPI.MMEMory.TR(1-1).TRACe(1-4).LOAD.LIMit.UPPer**

Syntax

SCPI.MMEMory.TR(1-1).TRACe(1-4).LOAD.LIMit.UPPer

Description

Reads the upper limit line (No Query)

Variable

	<b>&lt;String&gt;</b>
Range	-
Preset value	-
Unit	-
Resolution	-

Equivalent key

TR Menu -> Display -> Limit Test -> Import Upper Limit Line...

**SCPI.MMEMory.TR(1-1).TRACe(1-4).STORE.DATA**

Syntax

SCPI.MMEMory.TR(1-1).TRACe(1-4).STORE.DATA

Description

Saves trace data (No Read)

Variable

	<b>&lt;String&gt;</b>
Range	-
Preset value	-
Unit	-
Resolution	-

Equivalent key

No equivalent key is available on the front panel.

## **SCPI.MMEMory.TR(1-1).TRACe(1-4).STORE.MEMory**

Syntax SCPI.MMEMory.TR(1-1).TRACe(1-4).STORE.MEMory

Description Saves memory trace data (No Read)

Variable

	<String>
Range	-
Preset value	-
Unit	-
Resolution	-

Equivalent key No equivalent key is available on the front panel.

## **SCPI.MMEMory.USER(1-1).TRACe(1-8).LOAD.LIMit.LOWer**

Syntax SCPI.MMEMory.USER(1-1).TRACe(1-8).LOAD.LIMit.LOWer

Description Reads the lower limit line (No Query)

Variable

	<String>
Range	-
Preset value	-
Unit	-
Resolution	-

Equivalent key USER Menu -> Display -> Limit Test -> Import Lower Limit Line...

## **SCPI.MMEMory.USER(1-1).TRACe(1-8).LOAD.LIMit.UPPer**

Syntax SCPI.MMEMory.USER(1-1).TRACe(1-8).LOAD.LIMit.UPPer

Description Reads the upper limit line (No Query)

Variable

	<String>
Range	-
Preset value	-
Unit	-
Resolution	-

Equivalent key USER Menu -> Display -> Limit Test -> Import Upper Limit Line...

### **SCPI.MMEMory.USER(1-1).TRACe(1-8).STORE.DATA**

Syntax SCPI.MMEMory.USER(1-1).TRACe(1-8).STORE.DATA

Description Saves selected trace data (No Read)

Variable

	<String>
Range	-
Preset value	-
Unit	-
Resolution	-

Equivalent key No equivalent key is available on the front panel.

### **SCPI.MMEMory.USER(1-1).TRACe(1-8).STORE.MEMory**

Syntax SCPI.MMEMory.USER(1-1).TRACe(1-8).STORE.MEMory

Description Saves selected memory trace data (No Read)

Variable

	<String>
Range	-
Preset value	-
Unit	-
Resolution	-

Equivalent key No equivalent key is available on the front panel.

## SCPI.PROGram.CATalog

- Syntax** <string> = SCPI.PROGram.CATalog
- Description** List all the executable macro (Read Only)
- Equivalent key** No equivalent key is available on the front panel.

## SCPI.PROGram.COM.EVENT

- Syntax** SCPI.PROGram.COM.EVENT = <boolean>  
 <boolean> = SCPI.PROGram.COM.EVENT
- Description** Turns on/off the E5052 VBA event callback function
- Variable**

	Param
True or -1	Enable the E5052 VBA event callback function
False or 0(Preset value)	Disable the E5052 VBA event callback function

- Equivalent key** PN Menu -> Macro Setup -> E5052 Event  
 SP Menu -> Macro Setup -> E5052 Event  
 FP Menu -> Macro Setup -> E5052 Event  
 TR Menu -> Macro Setup -> E5052 Event  
 USER Menu -> Macro Setup -> E5052 Event

## SCPI.PROGram.SELected.NAME

- Syntax** SCPI.PROGram.SELected.NAME = <string>  
 <string> = SCPI.PROGram.SELected.NAME
- Description** Sets/reads the name of the program to be selected
- Variable**

	<String>
Range	-
Preset value	"E5052.Module1.Main"
Unit	-
Resolution	-

Equivalent key No equivalent key is available on the front panel.

### **SCPI.PROGram.SELected.STATe**

Syntax SCPI.PROGram.SELected.STATe = <string>  
<string> = SCPI.PROGram.SELected.STATe

Description Set/reads the state of the selected program

Variable

	<b>Param</b>
STOP(Preset value)	Set the state of the selected program to 'STOP'
RUN	Set the state of the selected program to 'RUN'

Equivalent key No equivalent key is available on the front panel.

### **SCPI.PROGram.SKEY.ITEM(1-8).ENABLE**

Syntax SCPI.PROGram.SKEY.ITEM(1-8).ENABLE = <boolean>  
<boolean> = SCPI.PROGram.SKEY.ITEM(1-8).ENABLE

Description Turns on/off user defined softkey function

Variable

	<b>Param</b>
True or -1	Set user defined softkey function to 'ON'
False or 0(Preset value)	Set user defined softkey function to 'OFF'

Equivalent key No equivalent key is available on the front panel.

### **SCPI.PROGram.SKEY.ITEM(1-8).IMMEDIATE**

Syntax SCPI.PROGram.SKEY.ITEM(1-8).IMMEDIATE

Description Execute the macro assigned under the user defined softkey (No Read)

Equivalent key PN Menu -> Macro Setup -> User Menu -> User Label 1  
SP Menu -> Macro Setup -> User Menu -> User Label 1  
FP Menu -> Macro Setup -> User Menu -> User Label 1  
TR Menu -> Macro Setup -> User Menu -> User Label 1



USER Menu -> Macro Setup -> User Menu -> User Label 1

### **SCPI.PROGRAM.SKEY.ITEM(1-8).LABEL**

**Syntax** SCPI.PROGRAM.SKEY.ITEM(1-8).LABEL = <string>  
 <string> = SCPI.PROGRAM.SKEY.ITEM(1-8).LABEL

**Description** Sets/reads the user defined softkey label

**Variable**

	<b>&lt;String&gt;</b>
Range	30 chars
Preset value	"User Label 1"
Unit	-
Resolution	-

**Equivalent key** No equivalent key is available on the front panel.

### **SCPI.PROGRAM.VARIABLE.ARRAY(1-10).DATA**

**Syntax** SCPI.PROGRAM.VARIABLE.ARRAY(1-10).DATA = <variant>  
 <variant> = SCPI.PROGRAM.VARIABLE.ARRAY(1-10).DATA

**Description** User defined array data

**Variable**

	<b>&lt;Variant&gt;</b>
Range	1...1601
Preset value	-
Unit	-
Resolution	-

**Equivalent key** No equivalent key is available on the front panel.

### **SCPI.PROGRAM.VARIABLE.ARRAY(1-10).POINTS**

**Syntax** SCPI.PROGRAM.VARIABLE.ARRAY(1-10).POINTS = <long>  
 <long> = SCPI.PROGRAM.VARIABLE.ARRAY(1-10).POINTS

**Description** # of points of user defined array

Variable

	<b>&lt;Long&gt;</b>
Range	2 to 1601
Preset value	1601
Unit	-
Resolution	-

Equivalent key No equivalent key is available on the front panel.

### **SCPI.PROGram.VARiable.DOUBle(1-10)**

Syntax SCPI.PROGram.VARiable.DOUBle(1-10) = <double>  
<double> = SCPI.PROGram.VARiable.DOUBle(1-10)

Description User defined 64bit floating variable

Variable

	<b>&lt;Double&gt;</b>
Range	-
Preset value	-
Unit	-
Resolution	-

Equivalent key No equivalent key is available on the front panel.

### **SCPI.PROGram.VARiable.INTeger(1-10)**

Syntax SCPI.PROGram.VARiable.INTeger(1-10) = <long>  
<long> = SCPI.PROGram.VARiable.INTeger(1-10)

Description User defined integer variable

Variable

	<b>&lt;Long&gt;</b>
Range	-
Preset value	-
Unit	-

	<b>&lt;Long&gt;</b>
Resolution	-

Equivalent key No equivalent key is available on the front panel.

### **SCPI.PROGRAM.VARIABLE.STRING(1-10)**

Syntax SCPI.PROGRAM.VARIABLE.STRING(1-10) = <string>  
 <string> = SCPI.PROGRAM.VARIABLE.STRING(1-10)

Description User defined string

Variable

	<b>&lt;String&gt;</b>
Range	-
Preset value	-
Unit	-
Resolution	-

Equivalent key No equivalent key is available on the front panel.

### **SCPI.SENSE.ATTENUATION.LEVEL**

Syntax SCPI.SENSE.ATTENUATION.LEVEL = <double>  
 <double> = SCPI.SENSE.ATTENUATION.LEVEL

Description Input Attenuator level on 5dB Step

Variable

	<b>&lt;Double&gt;</b>
Range	0 to 35
Preset value	5
Unit	dB
Resolution	5

Equivalent key PN Menu -> Attenuator -> Input Attenuator  
 SP Menu -> Attenuator -> Input Attenuator  
 FP Menu -> Attenuator -> Input Attenuator

COM Object Reference  
**SCPI.SENSE.FP(1-1).AVERAge.CLEAr**

TR Menu -> Attenuator -> Input Attenuator

USER Menu -> Attenuator -> Input Attenuator

**SCPI.SENSE.FP(1-1).AVERAge.CLEAr**

Syntax SCPI.SENSE.FP(1-1).AVERAge.CLEAr

Description Restart averaging (No Read)

Equivalent key FP Menu -> Average -> Averaging Restart

**SCPI.SENSE.FP(1-1).AVERAge.COUNT**

Syntax SCPI.SENSE.FP(1-1).AVERAge.COUNT = <long>

<long> = SCPI.SENSE.FP(1-1).AVERAge.COUNT

Description Sets/reads averaging count

Variable

	<b>&lt;Long&gt;</b>
Range	1 to 999
Preset value	16
Unit	-
Resolution	-

Equivalent key FP Menu -> Average -> Avg Factor

**SCPI.SENSE.FP(1-1).AVERAge.STATe**

Syntax SCPI.SENSE.FP(1-1).AVERAge.STATe = <boolean>

<boolean> = SCPI.SENSE.FP(1-1).AVERAge.STATe

Description Turns on/off averaging function

Variable

	<b>Param</b>
True or -1	Set averaging function to 'ON'
False or 0(Preset value)	Set averaging function to 'OFF'

Equivalent key FP Menu -> Average -> Averaging

### SCPI.SENSE.FP(1-1).FBANd

Syntax SCPI.SENSE.FP(1-1).FBANd = <string>  
<string> = SCPI.SENSE.FP(1-1).FBANd

Description Selects frequency band

Variable

	Param
LOW	Set frequency band to 'LOW'
HIGH(Preset value)	Set frequency band to 'HIGH'

Equivalent key FP Menu -> Setup -> Frequency Band

### SCPI.SENSE.FP(1-1).FREQuency.RESolution

Syntax SCPI.SENSE.FP(1-1).FREQuency.RESolution = <string>  
<string> = SCPI.SENSE.FP(1-1).FREQuency.RESolution

Description Sets/reads frequency resolution

Variable

	Param
NARRow	Set frequency resolution to 'NARRow'
MIDDle	Set frequency resolution to 'MIDDle'
WIDE(Preset value)	Set frequency resolution to 'WIDE'

Equivalent key FP Menu -> Setup -> Freq Resolution

### SCPI.SENSE.FP(1-1).SWEep.DWELI

Syntax SCPI.SENSE.FP(1-1).SWEep.DWELI = <double>  
<double> = SCPI.SENSE.FP(1-1).SWEep.DWELI

Description Sets/reads the point delay value

Variable

	<b>&lt;Double&gt;</b>
Range	0 to 1
Preset value	0
Unit	s
Resolution	100u

Equivalent key FP Menu -> Setup -> Point Delay

**SCPI.SENSE.FP(1-1).SWEp.TIME.DATA**

Syntax <double> = SCPI.SENSE.FP(1-1).SWEp.TIME.DATA

Description Reads the measurement time (Read Only)

Equivalent key No equivalent key is available on the front panel.

**SCPI.SENSE.PN(1-1).AVERAge.CLEAr**

Syntax SCPI.SENSE.PN(1-1).AVERAge.CLEAr

Description Averaging restart (No Read)

Equivalent key PN Menu -> Average -> Averaging Restart

**SCPI.SENSE.PN(1-1).AVERAge.COUNT**

Syntax SCPI.SENSE.PN(1-1).AVERAge.COUNT = <long>  
 <long> = SCPI.SENSE.PN(1-1).AVERAge.COUNT

Description Sets/reads average count

Variable

	<b>&lt;Long&gt;</b>
Range	1 to 999
Preset value	16
Unit	-
Resolution	-

Equivalent key PN Menu -> Average -> Avg Factor

## SCPI.SENSE.PN(1-1).AVERAge.STATe

**Syntax** SCPI.SENSE.PN(1-1).AVERAge.STATe = <boolean>  
 <boolean> = SCPI.SENSE.PN(1-1).AVERAge.STATe

**Description** turns on/off averaging mode

**Variable**

	<b>Param</b>
True or -1	Set average mode to 'ON'
False or 0(Preset value)	Set average mode to 'OFF'

**Equivalent key** PN Menu -> Average -> Averaging

## SCPI.SENSE.PN(1-1).CORRelation.COUNT

**Syntax** SCPI.SENSE.PN(1-1).CORRelation.COUNT = <long>  
 <long> = SCPI.SENSE.PN(1-1).CORRelation.COUNT

**Description** Sets/reads the number of correlation

**Variable**

	<b>&lt;Long&gt;</b>
Range	1 to 10000 (standard) 1 (option 011, fixed value)
Preset value	1
Unit	-
Resolution	-

**Equivalent key** PN Menu -> Average -> Correlation \*1

## SCPI.SENSE.PN(1-1).FBANd

**Syntax** SCPI.SENSE.PN(1-1).FBANd = <string>  
 <string> = SCPI.SENSE.PN(1-1).FBANd

**Description** Sets/reads frequency band

\*1. The softkey is not available when option 011 is installed.

Variable

	<b>Param</b>
BAND1	Set frequency band to 'BAND1'
BAND2	Set frequency band to 'BAND2'
BAND3	Set frequency band to 'BAND3'
BAND4(Preset value)	Set frequency band to 'BAND4'

Equivalent key PN Menu -> Setup -> Frequency Band

### **SCPI.SENSE.PN(1-1).FREQUENCY.START**

Syntax SCPI.SENSE.PN(1-1).FREQUENCY.START = <double>  
 <double> = SCPI.SENSE.PN(1-1).FREQUENCY.START

Description Selects start offset frequency

Variable

	<b>&lt;Double&gt;</b>
Range	1 10 100 1k (standard) 10 100 1k (option 011)
Preset value	1k
Unit	Hz
Resolution	-

Equivalent key PN Menu -> Start -> 1Hz<sup>\*1</sup>  
 PN Menu -> Start -> 10Hz  
 PN Menu -> Start -> 100Hz  
 PN Menu -> Start -> 1kHz  
 PN Menu -> Marker To -> Marker -> Start

### **SCPI.SENSE.PN(1-1).FREQUENCY.STOP**

Syntax SCPI.SENSE.PN(1-1).FREQUENCY.STOP = <double>  
 <double> = SCPI.SENSE.PN(1-1).FREQUENCY.STOP

Description Selects stop offset frequency

\*1. 1 Hz start offset frequency is not available when option 011 is installed.



Variable

	<Double>
Range	100k 1M 5M 10M 40M
Preset value	10M
Unit	Hz
Resolution	-

Equivalent key

PN Menu -> Stop -> 100kHz  
 PN Menu -> Stop -> 1MHz  
 PN Menu -> Stop -> 5MHz  
 PN Menu -> Stop -> 10MHz  
 PN Menu -> Stop -> 40MHz  
 PN Menu -> Marker To -> Marker -> Stop

### **SCPI.SENSE.PN(1-1).IFGain**

Syntax

SCPI.SENSE.PN(1-1).IFGain = <double>  
 <double> = SCPI.SENSE.PN(1-1).IFGain

Description

Sets/reads IF Gain at 10dB steps

Variable

	<Double>
Range	0 to 50 (standard) 10 (option 011, fixed value)
Preset value	20 (standard) 10 (option 011, fixed value)
Unit	dB
Resolution	10

Equivalent key

PN Menu -> Setup -> IF Gain \*1

### **SCPI.SENSE.PN(1-1).LOBandwidth**

Syntax

SCPI.SENSE.PN(1-1).LOBandwidth = <string>  
 <string> = SCPI.SENSE.PN(1-1).LOBandwidth

\*1. The value of IF Gain cannot be changed when option 011 is installed.

COM Object Reference  
**SCPI.SENSE.PN(1-1).SEGTable.MEASurement.QUALity**

Description Sets/readst phase noise Local bandwidth optimization

Variable

	Param
NARRow	Set phase noise Local bandwidth optimization to 'NARRow'
WIDE(Preset value)	Set phase noise Local bandwidth optimization to 'WIDE'

Equivalent key PN Menu -> Setup -> LO PhNoise Optimize

**SCPI.SENSE.PN(1-1).SEGTable.MEASurement.QUALity**

Syntax SCPI.SENSE.PN(1-1).SEGTable.MEASurement.QUALity = <string>  
 <string> = SCPI.SENSE.PN(1-1).SEGTable.MEASurement.QUALity

Description Sets/reads the quality level

Variable

	Param
NORMal(Preset value)	Set the quality level to 'Normal'
FAST	Set the quality level to 'Fast'

Equivalent key PN Menu -> Setup -> Measurement Quality

**SCPI.SENSE.PN(1-1).SWEep.POINts**

Syntax <long> = SCPI.SENSE.PN(1-1).SWEep.POINts

Description Reads the number of measurement points (Read Only)

Equivalent key No equivalent key is available on the front panel.

**SCPI.SENSE.ROSCillator.SOURce**

Syntax <string> = SCPI.SENSE.ROSCillator.SOURce

Description Reads the source of reference oscillator (Read Only)

Equivalent key No equivalent key is available on the front panel.

**SCPI.SENSE.SP(1-1).AVERage.CLEAr**

Syntax SCPI.SENSE.SP(1-1).AVERage.CLEAr

Description Restart averaging (No Read)  
 Equivalent key SP Menu -> Average/BW -> Averaging Restart

**SCPI.SENSE.SP(1-1).AVERAge.COUNT**

Syntax SCPI.SENSE.SP(1-1).AVERAge.COUNT = <long>  
 <long> = SCPI.SENSE.SP(1-1).AVERAge.COUNT

Description Sets/reads the averaging count

Variable

	<b>&lt;Long&gt;</b>
Range	1 to 999
Preset value	16
Unit	-
Resolution	-

Equivalent key SP Menu -> Average/BW -> Avg Factor

**SCPI.SENSE.SP(1-1).AVERAge.STATe**

Syntax SCPI.SENSE.SP(1-1).AVERAge.STATe = <boolean>  
 <boolean> = SCPI.SENSE.SP(1-1).AVERAge.STATe

Description Turns on/off averaging function

Variable

	<b>Param</b>
True or -1	Set averaging function to 'ON'
False or 0(Preset value)	Set averaging function to 'OFF'

Equivalent key SP Menu -> Average/BW -> Averaging

**SCPI.SENSE.SP(1-1).AVERAge.TYPE**

Syntax SCPI.SENSE.SP(1-1).AVERAge.TYPE = <string>  
 <string> = SCPI.SENSE.SP(1-1).AVERAge.TYPE

Description Sets/reads averaging type

COM Object Reference  
**SCPI.SENSE.SP(1-1).BANDwidth.RESolution**

Variable

	<b>Param</b>
RMS	Set averaging type to 'RMS'
LOGarithmic(Preset value)	Set averaging type to 'LOGarithmic'

Equivalent key SP Menu -> Average/BW -> Averaging Type

**SCPI.SENSE.SP(1-1).BANDwidth.RESolution**

Syntax SCPI.SENSE.SP(1-1).BANDwidth.RESolution = <double>  
 <double> = SCPI.SENSE.SP(1-1).BANDwidth.RESolution

Description Sets/reads RBW value

Variable

	<b>&lt;Double&gt;</b>
Range	1.53 to 400k
Preset value	25k
Unit	Hz
Resolution	-

Equivalent key SP Menu -> Average/BW -> RBW

**SCPI.SENSE.SP(1-1).CARRier.FBAND**

Syntax SCPI.SENSE.SP(1-1).CARRier.FBAND = <string>  
 <string> = SCPI.SENSE.SP(1-1).CARRier.FBAND

Description Sets/reads the carrier frequency band

Variable

	<b>Param</b>
LOW	Set the carrier frequency band to '10M-1.5GHz'
HIGH(Preset value)	Set the carrier frequency band to '300M-7GHz'

Equivalent key SP Menu -> Start/Center -> Carrier To -> Frequency Band  
 SP Menu -> Stop/Span -> Carrier To -> Frequency Band

## SCPI.SENSE.SP(1-1).CARRIER.SET.CENTER

**Syntax** SCPI.SENSE.SP(1-1).CARRIER.SET.CENTER

**Description** Changes the center frequency to N times the carrier frequency (No Query)

**Variable**

	<b>&lt;Double&gt;</b>
Range	1 to 20
Preset value	-
Unit	-
Resolution	1

**Equivalent key**

SP Menu -> Start/Center -> Carrier To -> Carrier -> Center  
 SP Menu -> Start/Center -> Carrier To -> Carrier x2 -> Center  
 SP Menu -> Start/Center -> Carrier To -> Carrier x3 -> Center  
 SP Menu -> Start/Center -> Carrier To -> Carrier x# -> Center  
 SP Menu -> Stop/Span -> Carrier To -> Carrier -> Center  
 SP Menu -> Stop/Span -> Carrier To -> Carrier x2 -> Center  
 SP Menu -> Stop/Span -> Carrier To -> Carrier x3 -> Center  
 SP Menu -> Stop/Span -> Carrier To -> Carrier x# -> Center

## SCPI.SENSE.SP(1-1).DETECTOR.FUNCTION

**Syntax** SCPI.SENSE.SP(1-1).DETECTOR.FUNCTION = <string>  
 <string> = SCPI.SENSE.SP(1-1).DETECTOR.FUNCTION

**Description** Sets/reads detector mode

**Variable**

	<b>Param</b>
POSitive(Preset value)	Set detector mode to 'POSitive'
SAMPle	Set detector mode to 'SAMPle'

**Equivalent key** SP Menu -> Format -> Detector Mode

## SCPI.SENSE.SP(1-1).FREQUENCY.CENTER

**Syntax** SCPI.SENSE.SP(1-1).FREQUENCY.CENTER = <double>

COM Object Reference  
**SCPI.SENSE.SP(1-1).FREQUENCY.SPAN**

<double> = SCPI.SENSE.SP(1-1).FREQUENCY.CENTER

Description Sets/reads the center value of frequency span

Variable

	<b>&lt;Double&gt;</b>
Range	10M to 7G
Preset value	1G
Unit	Hz
Resolution	100m

Equivalent key SP Menu -> Start/Center -> Center  
SP Menu -> Stop/Span -> Center  
SP Menu -> Marker To -> Marker -> Center

**SCPI.SENSE.SP(1-1).FREQUENCY.SPAN**

Syntax SCPI.SENSE.SP(1-1).FREQUENCY.SPAN = <double>  
<double> = SCPI.SENSE.SP(1-1).FREQUENCY.SPAN

Description Sets/reads the span value of frequency span

Variable

	<b>&lt;Double&gt;</b>
Range	100 to 15M
Preset value	15M
Unit	Hz
Resolution	200m

Equivalent key SP Menu -> Start/Center -> Span  
SP Menu -> Stop/Span -> Span

**SCPI.SENSE.SP(1-1).FREQUENCY.START**

Syntax SCPI.SENSE.SP(1-1).FREQUENCY.START = <double>  
<double> = SCPI.SENSE.SP(1-1).FREQUENCY.START

Description Sets/reads the start value of frequency span

Variable

	<Double>
Range	9M to 6.99999995G
Preset value	992.5M
Unit	Hz
Resolution	100m

Equivalent key

SP Menu -> Start/Center -> Start  
 SP Menu -> Stop/Span -> Start  
 SP Menu -> Marker To -> Marker -> Start

**SCPI.SENSE.SP(1-1).FREQUENCY.STOP**

Syntax

SCPI.SENSE.SP(1-1).FREQUENCY.STOP = <double>  
 <double> = SCPI.SENSE.SP(1-1).FREQUENCY.STOP

Description

Sets/reads the stop value of frequency span

Variable

	<Double>
Range	10.00005M to 7.0075G
Preset value	1.0075G
Unit	Hz
Resolution	100m

Equivalent key

SP Menu -> Start/Center -> Stop  
 SP Menu -> Stop/Span -> Stop  
 SP Menu -> Marker To -> Marker -> Stop

**SCPI.SENSE.SP(1-1).POWER.RLEVEL**

Syntax

SCPI.SENSE.SP(1-1).POWER.RLEVEL = <double>  
 <double> = SCPI.SENSE.SP(1-1).POWER.RLEVEL

Description

Sets/reads the reference level of frequency span

Variable

	<b>&lt;Double&gt;</b>
Range	-45 to 30
Preset value	5
Unit	dBm
Resolution	5

Equivalent key SP Menu -> Setup -> Reference Level

**SCPI.SENSE.SP(1-1).SWEep.POINts**

Syntax <long> = SCPI.SENSE.SP(1-1).SWEep.POINts

Description Reads the number of measurement points (Read Only)

Equivalent key No equivalent key is available on the front panel.

**SCPI.SENSE.TR(1-1).AVERAge.CLEAr**

Syntax SCPI.SENSE.TR(1-1).AVERAge.CLEAr

Description Averaging clear (No Read)

Equivalent key TR Menu -> Average -> Averaging Restart

**SCPI.SENSE.TR(1-1).AVERAge.COUNT**

Syntax SCPI.SENSE.TR(1-1).AVERAge.COUNT = <long>

<long> = SCPI.SENSE.TR(1-1).AVERAge.COUNT

Description Sets/reads average count

Variable

	<b>&lt;Long&gt;</b>
Range	1 to 999
Preset value	16
Unit	-
Resolution	-

Equivalent key TR Menu -> Average -> Avg Factor



## SCPI.SENSE.TR(1-1).AVERAge.STATe

**Syntax** SCPI.SENSE.TR(1-1).AVERAge.STATe = <boolean>  
 <boolean> = SCPI.SENSE.TR(1-1).AVERAge.STATe

**Description** Turns on/off averaging function

**Variable**

	<b>Param</b>
True or -1	Set averaging function to 'ON'
False or 0(Preset value)	Set averaging function to 'OFF'

**Equivalent key** TR Menu -> Average -> Averaging

## SCPI.SENSE.TR(1-1).NARRow.FREQuency.PREFeRence

**Syntax** SCPI.SENSE.TR(1-1).NARRow.FREQuency.PREFeRence = <double>  
 <double> = SCPI.SENSE.TR(1-1).NARRow.FREQuency.PREFeRence

**Description** Sets/reads the phase reference frequency

**Variable**

	<b>&lt;Double&gt;</b>
Range	9.2M to 7.0128G
Preset value	1G
Unit	Hz
Resolution	-

**Equivalent key** TR Menu -> Setup -> Phase Reference  
 TR Menu -> Marker To -> Marker -> Phase Reference

## SCPI.SENSE.TR(1-1).NARRow.FREQuency.RANGe

**Syntax** SCPI.SENSE.TR(1-1).NARRow.FREQuency.RANGe = <string>  
 <string> = SCPI.SENSE.TR(1-1).NARRow.FREQuency.RANGe

**Description** Sets/reads the frequency transient range in narrowband mode

Variable

	Param
R25_6(Preset value)	Set frequency span to 'R25_6' (25.6 MHz)
R1_6	Set frequency span to 'R1_6' (1.6 MHz)
R0_2	Set frequency span to 'R0_2' (200kHz)

Equivalent key TR Menu -> Setup -> Freq Range

### **SCPI.SENSE.TR(1-1).NARROW.FREQUENCY.TARGET**

Syntax SCPI.SENSE.TR(1-1).NARROW.FREQUENCY.TARGET = <double>  
 <double> = SCPI.SENSE.TR(1-1).NARROW.FREQUENCY.TARGET

Description Sets/reads the target frequency value in narrowband mode

Variable

	<Double>
Range	10 MHz to 7 GHz
Preset value	1G
Unit	Hz
Resolution	-

Equivalent key TR Menu -> Setup -> Target Freq  
 TR Menu -> Marker To -> Marker -> Target Freq

### **SCPI.SENSE.TR(1-1).NARROW.SWEEP.POINTS**

Syntax <long> = SCPI.SENSE.TR(1-1).NARROW.SWEEP.POINTS

Description Sets/reads the number of measurement points (Read Only)

Equivalent key No equivalent key is available on the front panel.

### **SCPI.SENSE.TR(1-1).NARROW.TIME.OFFSET**

Syntax SCPI.SENSE.TR(1-1).NARROW.TIME.OFFSET = <double>  
 <double> = SCPI.SENSE.TR(1-1).NARROW.TIME.OFFSET

Description Sets/reads the time offset(delay) relative to the reference point

Variable

	<Double>
Range	-80m to 1.1
Preset value	0
Unit	s
Resolution	10n

Equivalent key

TR Menu -> Time Offset -> Narrow Time Offset  
 TR Menu -> Span -> Narrow Time Offset

**SCPI.SENSE.TR(1-1).NARROW.TIME.REFERENCE**

Syntax

SCPI.SENSE.TR(1-1).NARROW.TIME.REFERENCE = <string>  
 <string> = SCPI.SENSE.TR(1-1).NARROW.TIME.REFERENCE

Description

Sets/reads the reference position

Variable

	Param
LEFT	Set reference position for span to 'LEFT'
CENTER(Preset value)	Set reference position for span to 'CENTER'
RIGHT	Set reference position for span to 'RIGHT'

Equivalent key

TR Menu -> Time Offset -> Narrow Ref Position  
 TR Menu -> Span -> Narrow Ref Position

**SCPI.SENSE.TR(1-1).NARROW.TIME.SPAN**

Syntax

SCPI.SENSE.TR(1-1).NARROW.TIME.SPAN = <double>  
 <double> = SCPI.SENSE.TR(1-1).NARROW.TIME.SPAN

Description

Sets/reads the time span

Variable

	<Double>
Range	0 to 100m
Preset value	100m

COM Object Reference  
**SCPI.SENSE.TR(1-1).POWER.INPUT.LEVEL.MAXimum**

	<b>&lt;Double&gt;</b>
Unit	s
Resolution	10n

Equivalent key TR Menu -> Time Offset -> Narrow Span  
 TR Menu -> Span -> Narrow Span

**SCPI.SENSE.TR(1-1).POWER.INPUT.LEVEL.MAXimum**

Syntax SCPI.SENSE.TR(1-1).POWER.INPUT.LEVEL.MAXimum = <double>  
 <double> = SCPI.SENSE.TR(1-1).POWER.INPUT.LEVEL.MAXimum

Description Sets/reads maximum input level

Variable

	<b>&lt;Double&gt;</b>
Range	-45 to 30
Preset value	0
Unit	dBm
Resolution	100m

Equivalent key TR Menu -> Setup -> Max Input Level

**SCPI.SENSE.TR(1-1).WIDE.FREQUENCY.MAXimum**

Syntax SCPI.SENSE.TR(1-1).WIDE.FREQUENCY.MAXimum = <double>  
 <double> = SCPI.SENSE.TR(1-1).WIDE.FREQUENCY.MAXimum

Description Sets/reads transient frequency range in the wideband mode

Variable

	<b>&lt;Double&gt;</b>
Range	150M 300M 600M 900M 1.2G 1.5G 1.8G 2.4G 3G 3.6G 4.2G 4.8G 5.4G 6G 6.6G 7.2G
Preset value	1.2G
Unit	Hz
Resolution	-

Equivalent key No equivalent key is available on the front panel.

### **SCPI.SENSE.TR(1-1).WIDE.SWEp.POINts**

- Syntax <long> = SCPI.SENSE.TR(1-1).WIDE.SWEp.POINts
- Description Sets/reads the number of measurement points (Read Only)
- Equivalent key No equivalent key is available on the front panel.

### **SCPI.SENSE.TR(1-1).WIDE.TIME.OFFSet**

- Syntax SCPI.SENSE.TR(1-1).WIDE.TIME.OFFSet = <double>  
 <double> = SCPI.SENSE.TR(1-1).WIDE.TIME.OFFSet
- Description Sets/reads the time offset(delay) relative to the reference point
- Variable

	<b>&lt;Double&gt;</b>
Range	-80m to 1.1
Preset value	0
Unit	s
Resolution	10n

- Equivalent key TR Menu -> Time Offset -> Wide Time Offset  
 TR Menu -> Span -> Wide Time Offset

### **SCPI.SENSE.TR(1-1).WIDE.TIME.REFerence**

- Syntax SCPI.SENSE.TR(1-1).WIDE.TIME.REFerence = <string>  
 <string> = SCPI.SENSE.TR(1-1).WIDE.TIME.REFerence
- Description Sets/reads the reference position (wideband)
- Variable

	<b>Param</b>
LEFT	Set reference position for span to 'LEFT'
CENTer(Preset value)	Set reference position for span to 'CENTER'
RIGHt	Set reference position for span to 'RIGHT'

- Equivalent key TR Menu -> Time Offset -> Wide Ref Position  
 TR Menu -> Span -> Wide Ref Position

## **SCPI.SENSE.TR(1-1).WIDE.TIME.SPAN**

Syntax SCPI.SENSE.TR(1-1).WIDE.TIME.SPAN = <double>  
<double> = SCPI.SENSE.TR(1-1).WIDE.TIME.SPAN

Description Sets/reads the time span

Variable

	<b>&lt;Double&gt;</b>
Range	0 to 100m
Preset value	100m
Unit	s
Resolution	10n

Equivalent key TR Menu -> Time Offset -> Wide Span

TR Menu -> Span -> Wide Span

## **SCPI.SOURce.FP(1-1).SWEep.PARAmeter**

Syntax SCPI.SOURce.FP(1-1).SWEep.PARAmeter = <string>  
<string> = SCPI.SOURce.FP(1-1).SWEep.PARAmeter

Description Sets/reads sweep parameter

Variable

	<b>Param</b>
CONTRol(Preset value)	Set sweep parameter to 'CONTRol'
POWer	Set sweep parameter to 'POWer'

Equivalent key FP Menu -> Setup -> Sweep Parameter

## **SCPI.SOURce.FP(1-1).SWEep.POINts**

Syntax SCPI.SOURce.FP(1-1).SWEep.POINts = <long>  
<long> = SCPI.SOURce.FP(1-1).SWEep.POINts

Description Sets/reads the number of measurement points

Variable

	<Long>
Range	2 to 1001
Preset value	201
Unit	-
Resolution	-

Equivalent key FP Menu -> Setup -> Points

**SCPI.SOURce.FP(1-1).VOLTage.CONTRol.CENTer**

Syntax SCPI.SOURce.FP(1-1).VOLTage.CONTRol.CENTer = <double>  
 <double> = SCPI.SOURce.FP(1-1).VOLTage.CONTRol.CENTer

Description Vcontrol center

Variable

	<Double>
Range	-15 to 35
Preset value	50u
Unit	V
Resolution	50u

Equivalent key FP Menu -> Start/Center -> DC Control Center  
 FP Menu -> Stop/Span -> DC Control Center

**SCPI.SOURce.FP(1-1).VOLTage.CONTRol.SPAN**

Syntax SCPI.SOURce.FP(1-1).VOLTage.CONTRol.SPAN = <double>  
 <double> = SCPI.SOURce.FP(1-1).VOLTage.CONTRol.SPAN

Description Vcontrol span

Variable

	<Double>
Range	0 to 50
Preset value	100u

	<b>&lt;Double&gt;</b>
Unit	V
Resolution	100u

Equivalent key FP Menu -> Start/Center -> DC Control Span

FP Menu -> Stop/Span -> DC Control Span

### **SCPI.SOURce.FP(1-1).VOLTage.CONTRol.STARt**

Syntax SCPI.SOURce.FP(1-1).VOLTage.CONTRol.STARt = <double>

<double> = SCPI.SOURce.FP(1-1).VOLTage.CONTRol.STARt

Description Vcontrol start

Variable

	<b>&lt;Double&gt;</b>
Range	-15 to 35
Preset value	0
Unit	V
Resolution	100u

Equivalent key FP Menu -> Start/Center -> DC Control Start

FP Menu -> Stop/Span -> DC Control Start

### **SCPI.SOURce.FP(1-1).VOLTage.CONTRol.STOP**

Syntax SCPI.SOURce.FP(1-1).VOLTage.CONTRol.STOP = <double>

<double> = SCPI.SOURce.FP(1-1).VOLTage.CONTRol.STOP

Description Vcontrol stop

Variable

	<b>&lt;Double&gt;</b>
Range	-15 to 35
Preset value	100u
Unit	V
Resolution	100u



Equivalent key FP Menu -> Start/Center -> DC Control Stop  
 FP Menu -> Stop/Span -> DC Control Stop

### **SCPI.SOURce.FP(1-1).VOLTage.POWer.CENter**

Syntax SCPI.SOURce.FP(1-1).VOLTage.POWer.CENter = <double>  
 <double> = SCPI.SOURce.FP(1-1).VOLTage.POWer.CENter

Description Vpower center

Variable

	<b>&lt;Double&gt;</b>
Range	0 to 16
Preset value	500u
Unit	V
Resolution	500u

Equivalent key FP Menu -> Start/Center -> DC Power Center  
 FP Menu -> Stop/Span -> DC Power Center

### **SCPI.SOURce.FP(1-1).VOLTage.POWer.SPAN**

Syntax SCPI.SOURce.FP(1-1).VOLTage.POWer.SPAN = <double>  
 <double> = SCPI.SOURce.FP(1-1).VOLTage.POWer.SPAN

Description Vpower span

Variable

	<b>&lt;Double&gt;</b>
Range	0 to 16
Preset value	1m
Unit	V
Resolution	1m

Equivalent key FP Menu -> Start/Center -> DC Power Span  
 FP Menu -> Stop/Span -> DC Power Span

### **SCPI.SOURce.FP(1-1).VOLTage.POWer.STARt**

Syntax SCPI.SOURce.FP(1-1).VOLTage.POWer.STARt = <double>

COM Object Reference  
**SCPI.SOURce.FP(1-1).VOLTage.POWer.STOP**

<double> = SCPI.SOURce.FP(1-1).VOLTage.POWer.STARt

Description Vpower start

Variable

	<Double>
Range	0 to 16
Preset value	0
Unit	V
Resolution	1m

Equivalent key FP Menu -> Start/Center -> DC Power Start

FP Menu -> Stop/Span -> DC Power Start

**SCPI.SOURce.FP(1-1).VOLTage.POWer.STOP**

Syntax SCPI.SOURce.FP(1-1).VOLTage.POWer.STOP = <double>

<double> = SCPI.SOURce.FP(1-1).VOLTage.POWer.STOP

Description Vpower stop

Variable

	<Double>
Range	0 to 16
Preset value	1m
Unit	V
Resolution	1m

Equivalent key FP Menu -> Start/Center -> DC Power Stop

FP Menu -> Stop/Span -> DC Power Stop

**SCPI.SOURce.VOLTage.CONTRol.AFC.FBANd**

Syntax SCPI.SOURce.VOLTage.CONTRol.AFC.FBANd = <string>

<string> = SCPI.SOURce.VOLTage.CONTRol.AFC.FBANd

Description Sets/reads the frequency band in the auto frequency control function

Variable

	Param
LOW	Set the frequency band in the auto frequency control function to '10M-1.5GHz'
HIGH(Preset value)	Set the frequency band in the auto frequency control function to '300M-7GHz'

Equivalent key

PN Menu -> DC Control Voltage -> Auto Freq Control -> Frequency Band  
 SP Menu -> DC Control Voltage -> Auto Freq Control -> Frequency Band  
 FP Menu -> DC Control Voltage -> Auto Freq Control -> Frequency Band  
 TR Menu -> DC Control Voltage -> Auto Freq Control -> Frequency Band  
 USER Menu -> DC Control Voltage -> Auto Freq Control -> Frequency Band

### **SCPI.SOURce.VOLTage.CONTRol.AFC.IMMediate**

Syntax

SCPI.SOURce.VOLTage.CONTRol.AFC.IMMediate

Description

Executes the auto frequency control once. (No Query)

Equivalent key

PN Menu -> DC Control Voltage -> Auto Freq Control -> AFC Status  
 SP Menu -> DC Control Voltage -> Auto Freq Control -> AFC Status  
 FP Menu -> DC Control Voltage -> Auto Freq Control -> AFC Status  
 TR Menu -> DC Control Voltage -> Auto Freq Control -> AFC Status  
 USER Menu -> DC Control Voltage -> Auto Freq Control -> AFC Status

### **SCPI.SOURce.VOLTage.CONTRol.AFC.ITERation**

Syntax

SCPI.SOURce.VOLTage.CONTRol.AFC.ITERation = <long>  
 <long> = SCPI.SOURce.VOLTage.CONTRol.AFC.ITERation

Description

Sets/reads the maximum number of iterations for the DC control voltage-setting loops

Variable

	<Long>
Range	1 to 99
Preset value	10
Unit	-
Resolution	-

Equivalent key

PN Menu -> DC Control Voltage -> Auto Freq Control -> Max Iteration

SP Menu -> DC Control Voltage -> Auto Freq Control -> Max Iteration

FP Menu -> DC Control Voltage -> Auto Freq Control -> Max Iteration

TR Menu -> DC Control Voltage -> Auto Freq Control -> Max Iteration

USER Menu -> DC Control Voltage -> Auto Freq Control -> Max Iteration

**SCPI.SOURce.VOLTage.CONTRol.AFC.LIMit.HIGH**

## Syntax

SCPI.SOURce.VOLTage.CONTRol.AFC.LIMit.HIGH = <double>

<double> = SCPI.SOURce.VOLTage.CONTRol.AFC.LIMit.HIGH

## Description

Sets/reads the maximum DC control voltage limit

## Variable

	<b>&lt;Double&gt;</b>
Range	-15 to 35
Preset value	35
Unit	V
Resolution	100u

## Equivalent key

PN Menu -> DC Control Voltage -> Auto Freq Control -> Max Ctrl Voltage Limit

SP Menu -> DC Control Voltage -> Auto Freq Control -> Max Ctrl Voltage Limit

FP Menu -> DC Control Voltage -> Auto Freq Control -> Max Ctrl Voltage Limit

TR Menu -> DC Control Voltage -> Auto Freq Control -> Max Ctrl Voltage Limit

USER Menu -> DC Control Voltage -> Auto Freq Control -> Max Ctrl Voltage Limit

**SCPI.SOURce.VOLTage.CONTRol.AFC.LIMit.LOW**

## Syntax

SCPI.SOURce.VOLTage.CONTRol.AFC.LIMit.LOW = <double>

<double> = SCPI.SOURce.VOLTage.CONTRol.AFC.LIMit.LOW

## Description

Sets/reads the minimum DC control voltage limit

## Variable

	<b>&lt;Double&gt;</b>
Range	-15 to 35
Preset value	-15
Unit	V
Resolution	100u

Equivalent key  
 PN Menu -> DC Control Voltage -> Auto Freq Control -> Min Ctrl Voltage Limit  
 SP Menu -> DC Control Voltage -> Auto Freq Control -> Min Ctrl Voltage Limit  
 FP Menu -> DC Control Voltage -> Auto Freq Control -> Min Ctrl Voltage Limit  
 TR Menu -> DC Control Voltage -> Auto Freq Control -> Min Ctrl Voltage Limit  
 USER Menu -> DC Control Voltage -> Auto Freq Control -> Min Ctrl Voltage Limit

### **SCPI.SOURce.VOLTage.CONTRol.AFC.SENSitivity**

Syntax  
 SCPI.SOURce.VOLTage.CONTRol.AFC.SENSitivity = <double>  
 <double> = SCPI.SOURce.VOLTage.CONTRol.AFC.SENSitivity

Description  
 Sets/reads the tuning sensitivity

Variable

	<b>&lt;Double&gt;</b>
Range	-5G to 5G
Preset value	10M
Unit	Hz/V
Resolution	1

Equivalent key  
 PN Menu -> DC Control Voltage -> Auto Freq Control -> Sensitivity  
 SP Menu -> DC Control Voltage -> Auto Freq Control -> Sensitivity  
 FP Menu -> DC Control Voltage -> Auto Freq Control -> Sensitivity  
 TR Menu -> DC Control Voltage -> Auto Freq Control -> Sensitivity  
 USER Menu -> DC Control Voltage -> Auto Freq Control -> Sensitivity

### **SCPI.SOURce.VOLTage.CONTRol.AFC.STATE**

Syntax  
 SCPI.SOURce.VOLTage.CONTRol.AFC.STATE = <boolean>  
 <boolean> = SCPI.SOURce.VOLTage.CONTRol.AFC.STATE

Description  
 Turns on/off the auto frequency control function

Variable

	<b>Param</b>
True or -1	Turn on the auto frequency control function mode
False or 0(Preset value)	Turn off the auto frequency control function mode

Equivalent key PN Menu -> DC Control Voltage -> Auto Freq Control -> AFC Status  
 SP Menu -> DC Control Voltage -> Auto Freq Control -> AFC Status  
 FP Menu -> DC Control Voltage -> Auto Freq Control -> AFC Status  
 TR Menu -> DC Control Voltage -> Auto Freq Control -> AFC Status  
 USER Menu -> DC Control Voltage -> Auto Freq Control -> AFC Status

**SCPI.SOURce.VOLTage.CONTRol.AFC.TARGET**

Syntax SCPI.SOURce.VOLTage.CONTRol.AFC.TARGET = <double>

<double> = SCPI.SOURce.VOLTage.CONTRol.AFC.TARGET

Description Sets/reads the target frequency in the auto frequency control function

Variable

	<b>&lt;Double&gt;</b>
Range	10M to 7G
Preset value	1G
Unit	Hz
Resolution	100m

Equivalent key PN Menu -> DC Control Voltage -> Auto Freq Control -> Target  
 SP Menu -> DC Control Voltage -> Auto Freq Control -> Target  
 FP Menu -> DC Control Voltage -> Auto Freq Control -> Target  
 TR Menu -> DC Control Voltage -> Auto Freq Control -> Target  
 USER Menu -> DC Control Voltage -> Auto Freq Control -> Target

**SCPI.SOURce.VOLTage.CONTRol.AFC.TOLerance**

Syntax SCPI.SOURce.VOLTage.CONTRol.AFC.TOLerance = <double>

<double> = SCPI.SOURce.VOLTage.CONTRol.AFC.TOLerance

Description Sets/reads the tolerance limit

Variable

	<b>&lt;Double&gt;</b>
Range	20 to 10M
Preset value	1k
Unit	Hz

	<b>&lt;Double&gt;</b>
Resolution	100m

Equivalent key      PN Menu -> DC Control Voltage -> Auto Freq Control -> Tolerance  
 SP Menu -> DC Control Voltage -> Auto Freq Control -> Tolerance  
 FP Menu -> DC Control Voltage -> Auto Freq Control -> Tolerance  
 TR Menu -> DC Control Voltage -> Auto Freq Control -> Tolerance  
 USER Menu -> DC Control Voltage -> Auto Freq Control -> Tolerance

### **SCPI.SOURce.VOLTage.CONTRol.CORRection.COLLect.ACQuire**

Syntax                      SCPI.SOURce.VOLTage.CONTRol.CORRection.COLLect.ACQuire  
 Description                Execute DC CTRL DRIFT CAL (No Read)  
 Equivalent key            No equivalent key is available on the front panel.

### **SCPI.SOURce.VOLTage.CONTRol.CORRection.STATE**

Syntax                      SCPI.SOURce.VOLTage.CONTRol.CORRection.STATE = <boolean>  
                                  <boolean> = SCPI.SOURce.VOLTage.CONTRol.CORRection.STATE  
 Description                DC CTRL DRIFT CAL state  
 Variable

	<b>Param</b>
True or -1	Set DC CTRL DRIFT CAL state to 'ON'
False or 0(Preset value)	Set DC CTRL DRIFT CAL state to 'OFF'

Equivalent key            No equivalent key is available on the front panel.

### **SCPI.SOURce.VOLTage.CONTRol.DELay**

Syntax                      SCPI.SOURce.VOLTage.CONTRol.DELay = <double>  
                                  <double> = SCPI.SOURce.VOLTage.CONTRol.DELay  
 Description                DC Control delay(sec)

Variable

	<b>&lt;Double&gt;</b>
Range	0 to 1
Preset value	100m
Unit	s
Resolution	1m

Equivalent key

PN Menu -> DC Control Voltage -> DC Control Delay  
 SP Menu -> DC Control Voltage -> DC Control Delay  
 FP Menu -> DC Control Voltage -> DC Control Delay  
 TR Menu -> DC Control Voltage -> DC Control Delay  
 USER Menu -> DC Control Voltage -> DC Control Delay

### **SCPI.SOURce.VOLTage.CONTRol.LEVel.AMPLitude**

Syntax

SCPI.SOURce.VOLTage.CONTRol.LEVel.AMPLitude = <double>  
 <double> = SCPI.SOURce.VOLTage.CONTRol.LEVel.AMPLitude

Description

fixed Vcontrol value at Vpower sweep

Variable

	<b>&lt;Double&gt;</b>
Range	-15 to 35
Preset value	0
Unit	V
Resolution	100u

Equivalent key

PN Menu -> DC Control Voltage -> DC Control Voltage  
 SP Menu -> DC Control Voltage -> DC Control Voltage  
 FP Menu -> DC Control Voltage -> DC Control Voltage  
 TR Menu -> DC Control Voltage -> DC Control Voltage  
 USER Menu -> DC Control Voltage -> DC Control Voltage

### **SCPI.SOURce.VOLTage.CONTRol.LEVel.STATe**

Syntax

SCPI.SOURce.VOLTage.CONTRol.LEVel.STATe = <boolean>  
 <boolean> = SCPI.SOURce.VOLTage.CONTRol.LEVel.STATe



Description fixed Vcontrol On/Off at Vpower sweep

Variable

	Param
True or -1	Set fixed Vcontrol On/Off at Vpower sweep mode 'ON'
False or 0(Preset value)	Set fixed Vcontrol On/Off at Vpower sweep mode 'OFF'

Equivalent key  
 PN Menu -> DC Control Voltage -> DC Control Output  
 SP Menu -> DC Control Voltage -> DC Control Output  
 FP Menu -> DC Control Voltage -> DC Control Output  
 TR Menu -> DC Control Voltage -> DC Control Output  
 USER Menu -> DC Control Voltage -> DC Control Output

### **SCPI.SOURce.VOLTage.CONTRol.LIMit.HIGH**

Syntax  
 SCPI.SOURce.VOLTage.CONTRol.LIMit.HIGH = <double>  
 <double> = SCPI.SOURce.VOLTage.CONTRol.LIMit.HIGH

Description fixed Vcontrol high limit, Resolution 0.1mV

Variable

	<Double>
Range	-15 to 35
Preset value	35
Unit	V
Resolution	100u

Equivalent key  
 PN Menu -> DC Control Voltage -> Max Ctrl Voltage Limit  
 SP Menu -> DC Control Voltage -> Max Ctrl Voltage Limit  
 FP Menu -> DC Control Voltage -> Max Ctrl Voltage Limit  
 TR Menu -> DC Control Voltage -> Max Ctrl Voltage Limit  
 USER Menu -> DC Control Voltage -> Max Ctrl Voltage Limit

### **SCPI.SOURce.VOLTage.CONTRol.LIMit.LOW**

Syntax  
 SCPI.SOURce.VOLTage.CONTRol.LIMit.LOW = <double>  
 <double> = SCPI.SOURce.VOLTage.CONTRol.LIMit.LOW

COM Object Reference  
**SCPI.SOURce.VOLTage.POWER.DELay**

Description fixed Vcontrol low limit, Resolution 0.1mdV

Variable

	<b>&lt;Double&gt;</b>
Range	-15 to 35
Preset value	-15
Unit	V
Resolution	100u

Equivalent key  
 PN Menu -> DC Control Voltage -> Min Ctrl Voltage Limit  
 SP Menu -> DC Control Voltage -> Min Ctrl Voltage Limit  
 FP Menu -> DC Control Voltage -> Min Ctrl Voltage Limit  
 TR Menu -> DC Control Voltage -> Min Ctrl Voltage Limit  
 USER Menu -> DC Control Voltage -> Min Ctrl Voltage Limit

**SCPI.SOURce.VOLTage.POWER.DELay**

Syntax  
 SCPI.SOURce.VOLTage.POWER.DELay = <double>  
 <double> = SCPI.SOURce.VOLTage.POWER.DELay

Description Src Power setting delay(sec)

Variable

	<b>&lt;Double&gt;</b>
Range	0 to 1
Preset value	100m
Unit	s
Resolution	1m

Equivalent key  
 PN Menu -> DC Power Voltage -> DC Power Delay  
 SP Menu -> DC Power Voltage -> DC Power Delay  
 FP Menu -> DC Power Voltage -> DC Power Delay  
 TR Menu -> DC Power Voltage -> DC Power Delay  
 USER Menu -> DC Power Voltage -> DC Power Delay

**SCPI.SOURce.VOLTage.POWER.LEVel.AMPLitude**

Syntax  
 SCPI.SOURce.VOLTage.POWER.LEVel.AMPLitude = <double>

<double> = SCPI.SOURce.VOLTage.POWer.LEVel.AMPLitude

Description fixed Vpower value at Vcontrol sweep

Variable

	<b>&lt;Double&gt;</b>
Range	0 to 16
Preset value	0
Unit	V
Resolution	1m

Equivalent key  
 PN Menu -> DC Power Voltage -> DC Power Voltage  
 SP Menu -> DC Power Voltage -> DC Power Voltage  
 FP Menu -> DC Power Voltage -> DC Power Voltage  
 TR Menu -> DC Power Voltage -> DC Power Voltage  
 USER Menu -> DC Power Voltage -> DC Power Voltage

### **SCPI.SOURce.VOLTage.POWer.LEVel.STATe**

Syntax  
 SCPI.SOURce.VOLTage.POWer.LEVel.STATe = <boolean>  
 <boolean> = SCPI.SOURce.VOLTage.POWer.LEVel.STATe

Description fixed Vpower On/Off at Vcontrol sweep

Variable

	<b>Param</b>
True or -1	Set fixed Vpower On/Off at Vcontrol sweep mode 'ON'
False or 0(Preset value)	Set fixed Vpower On/Off at Vcontrol sweep mode 'OFF'

Equivalent key  
 PN Menu -> DC Power Voltage -> DC Power Output  
 SP Menu -> DC Power Voltage -> DC Power Output  
 FP Menu -> DC Power Voltage -> DC Power Output  
 TR Menu -> DC Power Voltage -> DC Power Output  
 USER Menu -> DC Power Voltage -> DC Power Output

### **SCPI.SOURce.VOLTage.POWer.LIMit.HIGH**

Syntax  
 SCPI.SOURce.VOLTage.POWer.LIMit.HIGH = <double>

COM Object Reference  
**SCPI.SOURce.VOLTage.POWER.LIMit.LOW**

<double> = SCPI.SOURce.VOLTage.POWER.LIMit.HIGH

Description fixed Vpower high limit, Resolution 1mV

Variable

	<Double>
Range	0 to 16
Preset value	16
Unit	V
Resolution	1m

Equivalent key  
PN Menu -> DC Power Voltage -> Max Pwr Voltage Limit  
SP Menu -> DC Power Voltage -> Max Pwr Voltage Limit  
FP Menu -> DC Power Voltage -> Max Pwr Voltage Limit  
TR Menu -> DC Power Voltage -> Max Pwr Voltage Limit  
USER Menu -> DC Power Voltage -> Max Pwr Voltage Limit

**SCPI.SOURce.VOLTage.POWER.LIMit.LOW**

Syntax  
SCPI.SOURce.VOLTage.POWER.LIMit.LOW = <double>  
<double> = SCPI.SOURce.VOLTage.POWER.LIMit.LOW

Description fixed Vpower low limit, Resolution 1mdV

Variable

	<Double>
Range	0 to 16
Preset value	0
Unit	V
Resolution	1m

Equivalent key  
PN Menu -> DC Power Voltage -> Min Pwr Voltage Limit  
SP Menu -> DC Power Voltage -> Min Pwr Voltage Limit  
FP Menu -> DC Power Voltage -> Min Pwr Voltage Limit  
TR Menu -> DC Power Voltage -> Min Pwr Voltage Limit  
USER Menu -> DC Power Voltage -> Min Pwr Voltage Limit

### **SCPI.STATus.OPERation.BIT12.CLEar**

Syntax SCPI.STATus.OPERation.BIT12.CLEar = <long>

Description Clears operation-program status condition register (No Read)

Variable

	<Long>
Range	0 to 14
Preset value	-
Unit	-
Resolution	-

Equivalent key No equivalent key is available on the front panel.

### **SCPI.STATus.OPERation.BIT12.CONDition**

Syntax <long> = SCPI.STATus.OPERation.BIT12.CONDition

Description Reads operation-program status register (Read Only)

Equivalent key No equivalent key is available on the front panel.

### **SCPI.STATus.OPERation.BIT12.ENABLE**

Syntax SCPI.STATus.OPERation.BIT12.ENABLE = <long>  
 <long> = SCPI.STATus.OPERation.BIT12.ENABLE

Description Sets/reads operation-program status enable register

Variable

	<Long>
Range	0 to 65535
Preset value	0
Unit	-
Resolution	-

Equivalent key No equivalent key is available on the front panel.

## SCPI.STATus.OPERation.BIT12.EVENT

Syntax	<long> = SCPI.STATus.OPERation.BIT12.EVENT
Description	Reads operation-program status event register (Read Only)
Equivalent key	No equivalent key is available on the front panel.

## SCPI.STATus.OPERation.BIT12.NTRansition

Syntax	SCPI.STATus.OPERation.BIT12.NTRansition = <long> <long> = SCPI.STATus.OPERation.BIT12.NTRansition
Description	Sets/reads operation-program status negative transition filter value
Variable	

	<Long>
Range	0 to 65535
Preset value	0
Unit	-
Resolution	-

Equivalent key	No equivalent key is available on the front panel.
----------------	--

## SCPI.STATus.OPERation.BIT12.PTRansition

Syntax	SCPI.STATus.OPERation.BIT12.PTRansition = <long> <long> = SCPI.STATus.OPERation.BIT12.PTRansition
Description	Sets/reads operation-program status positive transition filter value
Variable	

	<Long>
Range	0 to 65535
Preset value	32767
Unit	-
Resolution	-

Equivalent key	No equivalent key is available on the front panel.
----------------	--

## SCPI.STATus.OPERation.BIT12.SET

Syntax SCPI.STATus.OPERation.BIT12.SET = <long>

Description Sets operation-program status condition register (No Read)

Variable

	<Long>
Range	0 to 14
Preset value	-
Unit	-
Resolution	-

Equivalent key No equivalent key is available on the front panel.

## SCPI.STATus.OPERation.CONDition

Syntax <long> = SCPI.STATus.OPERation.CONDition

Description Reads operation status conditional register value (Read Only)

Equivalent key No equivalent key is available on the front panel.

## SCPI.STATus.OPERation.ENABLE

Syntax SCPI.STATus.OPERation.ENABLE = <long>  
 <long> = SCPI.STATus.OPERation.ENABLE

Description Set/reads operation status enable register

Variable

	<Long>
Range	0 to 65535
Preset value	0
Unit	-
Resolution	-

Equivalent key No equivalent key is available on the front panel.

## **SCPI.STATus.OPERation.EVENT**

Syntax	<long> = SCPI.STATus.OPERation.EVENT
Description	Reads operation status event register (Read Only)
Equivalent key	No equivalent key is available on the front panel.

## **SCPI.STATus.OPERation.NTRansition**

Syntax	SCPI.STATus.OPERation.NTRansition = <long> <long> = SCPI.STATus.OPERation.NTRansition
Description	Sets/reads operation status negative transition filter value
Variable	

	<b>&lt;Long&gt;</b>
Range	0 to 65535
Preset value	0
Unit	-
Resolution	-

Equivalent key	No equivalent key is available on the front panel.
----------------	--

## **SCPI.STATus.OPERation.PTRansition**

Syntax	SCPI.STATus.OPERation.PTRansition = <long> <long> = SCPI.STATus.OPERation.PTRansition
Description	Sets/reads operation status positive transition filter value
Variable	

	<b>&lt;Long&gt;</b>
Range	0 to 65535
Preset value	32767
Unit	-
Resolution	-

Equivalent key	No equivalent key is available on the front panel.
----------------	--



### **SCPI.STATus.PRESet**

Syntax SCPI.STATus.PRESet

Description Reset status registers (No Read)

Equivalent key No equivalent key is available on the front panel.

### **SCPI.STATus.QUEStionable.CONDition**

Syntax <long> = SCPI.STATus.QUEStionable.CONDition

Description Reads questionable status conditional register value (Read Only)

Equivalent key No equivalent key is available on the front panel.

### **SCPI.STATus.QUEStionable.CURRent.ENABLE**

Syntax SCPI.STATus.QUEStionable.CURRent.ENABLE = <long>  
 <long> = SCPI.STATus.QUEStionable.CURRent.ENABLE

Description Sets/reads questionable-current status enable register

Variable

	<Long>
Range	0 to 65535
Preset value	0
Unit	-
Resolution	-

Equivalent key No equivalent key is available on the front panel.

### **SCPI.STATus.QUEStionable.CURRent.EVENT**

Syntax <long> = SCPI.STATus.QUEStionable.CURRent.EVENT

Description Reads questionable-current status event register value (Read Only)

Equivalent key No equivalent key is available on the front panel.

### **SCPI.STATus.QUEStionable.ENABLE**

Syntax SCPI.STATus.QUEStionable.ENABLE = <long>  
 <long> = SCPI.STATus.QUEStionable.ENABLE

Description Sets/reads questionable status enable register

Variable

	<Long>
Range	0 to 65535
Preset value	0
Unit	-
Resolution	-

Equivalent key No equivalent key is available on the front panel.

### **SCPI.STATus.QUEStionable.EVENT**

Syntax <long> = SCPI.STATus.QUEStionable.EVENT

Description Reads questionable status event register value (Read Only)

Equivalent key No equivalent key is available on the front panel.

### **SCPI.STATus.QUEStionable.LIMit.CONDition**

<long> = SCPI.STATus.QUEStionable.LIMit.CONDition

Description Reads the questionable limit conditional register value (Query Only)

Equivalent key No equivalent key is available on the front panel.

### **SCPI.STATus.QUEStionable.LIMit.ENABLE**

Syntax SCPI.STATus.QUEStionable.LIMit.ENABLE = <long>

<long> = SCPI.STATus.QUEStionable.LIMit.ENABLE

Description Sets/reads the questionable limit status enable value

Variable

	<Long>
Range	0 to 65535
Preset value	0
Unit	-
Resolution	-

Equivalent key No equivalent key is available on the front panel.

### **SCPI.STATus.QUEStionable.LIMit.EVENT**

<long> = SCPI.STATus.QUEStionable.LIMit.EVENT

- Description Reads the questionable limit status event register value (Query Only)
- Equivalent key No equivalent key is available on the front panel.

### **SCPI.STATus.QUEStionable.LIMit.FP(1-1).CONDition**

<long> = SCPI.STATus.QUEStionable.LIMit.FP(1-1).CONDition

- Description Reads the questionable limit FP1 conditional register value (Query Only)
- Equivalent key No equivalent key is available on the front panel.

### **SCPI.STATus.QUEStionable.LIMit.FP(1-1).ENABLE**

- Syntax SCPI.STATus.QUEStionable.LIMit.FP(1-1).ENABLE = <long>  
 <long> = SCPI.STATus.QUEStionable.LIMit.FP(1-1).ENABLE

Description Sets/reads the questionable limit FP1 status enable value

Variable

	<Long>
Range	0 to 65535
Preset value	0
Unit	-
Resolution	-

- Equivalent key No equivalent key is available on the front panel.

### **SCPI.STATus.QUEStionable.LIMit.FP(1-1).EVENT**

<long> = SCPI.STATus.QUEStionable.LIMit.FP(1-1).EVENT

- Description Reads the questionable limit FP1 status event register value (Query Only)
- Equivalent key No equivalent key is available on the front panel.

### **SCPI.STATus.QUEStionable.LIMit.FP(1-1).NTRansition**

- Syntax SCPI.STATus.QUEStionable.LIMit.FP(1-1).NTRansition = <long>  
 <long> = SCPI.STATus.QUEStionable.LIMit.FP(1-1).NTRansition

Description Sets/reads the questionable limit FP1 status negative transition filter value

Variable

	<b>&lt;Long&gt;</b>
Range	0 to 65535
Preset value	0
Unit	-
Resolution	-

Equivalent key No equivalent key is available on the front panel.

### **SCPI.STATus.QUEStionable.LIMit.FP(1-1).PTRansition**

Syntax SCPI.STATus.QUEStionable.LIMit.FP(1-1).PTRansition = <long>  
<long> = SCPI.STATus.QUEStionable.LIMit.FP(1-1).PTRansition

Description Sets/reads the questionable limit FP1 status positive transition filter value

Variable

	<b>&lt;Long&gt;</b>
Range	0 to 65535
Preset value	32767
Unit	-
Resolution	-

Equivalent key No equivalent key is available on the front panel.

### **SCPI.STATus.QUEStionable.LIMit.NTRansition**

Syntax SCPI.STATus.QUEStionable.LIMit.NTRansition = <long>  
<long> = SCPI.STATus.QUEStionable.LIMit.NTRansition

Description Sets/reads the questionable limit status negative transition filter value

Variable

	<b>&lt;Long&gt;</b>
Range	0 to 65535
Preset value	0
Unit	-

	<Long>
Resolution	-

Equivalent key No equivalent key is available on the front panel.

**SCPI.STATus.QUEStionable.LIMit.PN(1-1).CONDition**

<long> = SCPI.STATus.QUEStionable.LIMit.PN(1-1).CONDition

Description Reads the questionable limit PN1 conditional register value (Query Only)

Equivalent key No equivalent key is available on the front panel.

**SCPI.STATus.QUEStionable.LIMit.PN(1-1).ENABLE**

Syntax SCPI.STATus.QUEStionable.LIMit.PN(1-1).ENABLE = <long>

<long> = SCPI.STATus.QUEStionable.LIMit.PN(1-1).ENABLE

Description Sets/reads the questionable limit PN1 status enable value

Variable

	<Long>
Range	0 to 65535
Preset value	0
Unit	-
Resolution	-

Equivalent key No equivalent key is available on the front panel.

**SCPI.STATus.QUEStionable.LIMit.PN(1-1).EVENT**

<long> = SCPI.STATus.QUEStionable.LIMit.PN(1-1).EVENT

Description Reads the questionable limit PN1 status event register value (Query Only)

Equivalent key No equivalent key is available on the front panel.

**SCPI.STATus.QUEStionable.LIMit.PN(1-1).NTRansition**

Syntax SCPI.STATus.QUEStionable.LIMit.PN(1-1).NTRansition = <long>

<long> = SCPI.STATus.QUEStionable.LIMit.PN(1-1).NTRansition

Description Sets/reads the questionable limit PN1 status negative transition filter value

Variable

	<b>&lt;Long&gt;</b>
Range	0 to 65535
Preset value	0
Unit	-
Resolution	-

Equivalent key No equivalent key is available on the front panel.

### **SCPI.STATus.QUEStionable.LIMit.PN(1-1).PTRansition**

Syntax SCPI.STATus.QUEStionable.LIMit.PN(1-1).PTRansition = <long>  
<long> = SCPI.STATus.QUEStionable.LIMit.PN(1-1).PTRansition

Description Sets/reads the questionable limit PN1 status positive transition filter value

Variable

	<b>&lt;Long&gt;</b>
Range	0 to 65535
Preset value	32767
Unit	-
Resolution	-

Equivalent key No equivalent key is available on the front panel.

### **SCPI.STATus.QUEStionable.LIMit.PTRansition**

Syntax SCPI.STATus.QUEStionable.LIMit.PTRansition = <long>  
<long> = SCPI.STATus.QUEStionable.LIMit.PTRansition

Description Sets/reads the questionable limit status positive transition filter value

Variable

	<b>&lt;Long&gt;</b>
Range	0 to 65535
Preset value	32767
Unit	-

	<Long>
Resolution	-

Equivalent key No equivalent key is available on the front panel.

### **SCPI.STATus.QUEStionable.LIMit.SP(1-1).CONDition**

<long> = SCPI.STATus.QUEStionable.LIMit.SP(1-1).CONDition

Description Reads the questionable limit SP1 conditional register value (Query Only)

Equivalent key No equivalent key is available on the front panel.

### **SCPI.STATus.QUEStionable.LIMit.SP(1-1).ENABLE**

Syntax SCPI.STATus.QUEStionable.LIMit.SP(1-1).ENABLE = <long>

<long> = SCPI.STATus.QUEStionable.LIMit.SP(1-1).ENABLE

Description Sets/reads the questionable limit SP1 status enable value

Variable

	<Long>
Range	0 to 65535
Preset value	0
Unit	-
Resolution	-

Equivalent key No equivalent key is available on the front panel.

### **SCPI.STATus.QUEStionable.LIMit.SP(1-1).EVENT**

<long> = SCPI.STATus.QUEStionable.LIMit.SP(1-1).EVENT

Description Reads the questionable limit SP1 status event register value (Query Only)

Equivalent key No equivalent key is available on the front panel.

### **SCPI.STATus.QUEStionable.LIMit.SP(1-1).NTRansition**

Syntax SCPI.STATus.QUEStionable.LIMit.SP(1-1).NTRansition = <long>

<long> = SCPI.STATus.QUEStionable.LIMit.SP(1-1).NTRansition

Description Sets/reads the questionable limit SP1 status negative transition filter value

Variable

	<b>&lt;Long&gt;</b>
Range	0 to 65535
Preset value	0
Unit	-
Resolution	-

Equivalent key No equivalent key is available on the front panel.

### **SCPI.STATus.QUEStionable.LIMit.SP(1-1).PTRansition**

Syntax SCPI.STATus.QUEStionable.LIMit.SP(1-1).PTRansition = <long>  
 <long> = SCPI.STATus.QUEStionable.LIMit.SP(1-1).PTRansition

Description Sets/reads the questionable limit SP1 status positive transition filter value

Variable

	<b>&lt;Long&gt;</b>
Range	0 to 65535
Preset value	32767
Unit	-
Resolution	-

Equivalent key No equivalent key is available on the front panel.

### **SCPI.STATus.QUEStionable.LIMit.TR(1-1).CONDition**

<long> = SCPI.STATus.QUEStionable.LIMit.TR(1-1).CONDition

Description Reads the questionable limit TR1 conditional register value (Query Only)

Equivalent key No equivalent key is available on the front panel.

### **SCPI.STATus.QUEStionable.LIMit.TR(1-1).ENABLE**

Syntax SCPI.STATus.QUEStionable.LIMit.TR(1-1).ENABLE = <long>  
 <long> = SCPI.STATus.QUEStionable.LIMit.TR(1-1).ENABLE

Description Sets/reads the questionable limit TR1 status enable value



Variable

	<Long>
Range	0 to 65535
Preset value	0
Unit	-
Resolution	-

Equivalent key No equivalent key is available on the front panel.

**SCPI.STATus.QUEStionable.LIMit.TR(1-1).EVENT**

<long> = SCPI.STATus.QUEStionable.LIMit.TR(1-1).EVENT

Description Reads the questionable limit TR1 status event register value (Query Only)

Equivalent key No equivalent key is available on the front panel.

**SCPI.STATus.QUEStionable.LIMit.TR(1-1).NTRansition**

Syntax SCPI.STATus.QUEStionable.LIMit.TR(1-1).NTRansition = <long>

<long> = SCPI.STATus.QUEStionable.LIMit.TR(1-1).NTRansition

Description Sets/reads the questionable limit TR1 status negative transition filter value

Variable

	<Long>
Range	0 to 65535
Preset value	0
Unit	-
Resolution	-

Equivalent key No equivalent key is available on the front panel.

**SCPI.STATus.QUEStionable.LIMit.TR(1-1).PTRansition**

Syntax SCPI.STATus.QUEStionable.LIMit.TR(1-1).PTRansition = <long>

<long> = SCPI.STATus.QUEStionable.LIMit.TR(1-1).PTRansition

Description Sets/reads the questionable limit TR1 status positive transition filter value

Variable

	<b>&lt;Long&gt;</b>
Range	0 to 65535
Preset value	32767
Unit	-
Resolution	-

Equivalent key No equivalent key is available on the front panel.

### **SCPI.STATus.QUEStionable.LIMit.USER(1-1).CONDition**

<long> = SCPI.STATus.QUEStionable.LIMit.USER(1-1).CONDition

Description Reads the questionable limit USER1 conditional register value (Query Only)

Equivalent key No equivalent key is available on the front panel.

### **SCPI.STATus.QUEStionable.LIMit.USER(1-1).ENABLE**

Syntax SCPI.STATus.QUEStionable.LIMit.USER(1-1).ENABLE = <long>

<long> = SCPI.STATus.QUEStionable.LIMit.USER(1-1).ENABLE

Description Sets/reads the questionable limit USER1 status enable value

Variable

	<b>&lt;Long&gt;</b>
Range	0 to 65535
Preset value	0
Unit	-
Resolution	-

Equivalent key No equivalent key is available on the front panel.

### **SCPI.STATus.QUEStionable.LIMit.USER(1-1).EVENT**

<long> = SCPI.STATus.QUEStionable.LIMit.USER(1-1).EVENT

Description Reads the questionable limit USER1 status event register value (Query Only)

Equivalent key No equivalent key is available on the front panel.

### **SCPI.STATus.QUEStionable.LIMit.USER(1-1).NTRansition**

**Syntax** SCPI.STATus.QUEStionable.LIMit.USER(1-1).NTRansition = <long>  
 <long> = SCPI.STATus.QUEStionable.LIMit.USER(1-1).NTRansition

**Description** Sets/reads the questionable limit USER1 status negative transition filter value

**Variable**

	<b>&lt;Long&gt;</b>
Range	0 to 65535
Preset value	0
Unit	-
Resolution	-

**Equivalent key** No equivalent key is available on the front panel.

### **SCPI.STATus.QUEStionable.LIMit.USER(1-1).PTRansition**

**Syntax** SCPI.STATus.QUEStionable.LIMit.USER(1-1).PTRansition = <long>  
 <long> = SCPI.STATus.QUEStionable.LIMit.USER(1-1).PTRansition

**Description** Sets/reads the questionable limit USER1 status positive transition filter value

**Variable**

	<b>&lt;Long&gt;</b>
Range	0 to 65535
Preset value	32767
Unit	-
Resolution	-

**Equivalent key** No equivalent key is available on the front panel.

### **SCPI.STATus.QUEStionable.MISC.ENABLE**

**Syntax** SCPI.STATus.QUEStionable.MISC.ENABLE = <long>  
 <long> = SCPI.STATus.QUEStionable.MISC.ENABLE

**Description** Sets/reads questionable-misc status enable register

Variable

	<b>&lt;Long&gt;</b>
Range	0 to 65535
Preset value	0
Unit	-
Resolution	-

Equivalent key No equivalent key is available on the front panel.

### **SCPI.STATus.QUEStionable.MISC.EVENT**

Syntax `<long> = SCPI.STATus.QUEStionable.MISC.EVENT`

Description Reads questionable-misc status event register value (Read Only)

Equivalent key No equivalent key is available on the front panel.

### **SCPI.STATus.QUEStionable.NTRansition**

Syntax `SCPI.STATus.QUEStionable.NTRansition = <long>`

`<long> = SCPI.STATus.QUEStionable.NTRansition`

Description Sets/reads questionable status negative transition filter value

Variable

	<b>&lt;Long&gt;</b>
Range	0 to 65535
Preset value	0
Unit	-
Resolution	-

Equivalent key No equivalent key is available on the front panel.

### **SCPI.STATus.QUEStionable.PHASE.ENABLE**

Syntax `SCPI.STATus.QUEStionable.PHASE.ENABLE = <long>`

`<long> = SCPI.STATus.QUEStionable.PHASE.ENABLE`

Description Sets/reads questionable-phase status enable register

Variable

	<Long>
Range	0 to 65535
Preset value	0
Unit	-
Resolution	-

Equivalent key No equivalent key is available on the front panel.

**SCPI.STATus.QUEStionable.PHASE.EVENT**

Syntax <long> = SCPI.STATus.QUEStionable.PHASE.EVENT

Description Reads questionable-phase status event register (Read Only)

Equivalent key No equivalent key is available on the front panel.

**SCPI.STATus.QUEStionable.POWER.ENABLE**

Syntax SCPI.STATus.QUEStionable.POWER.ENABLE = <long>

<long> = SCPI.STATus.QUEStionable.POWER.ENABLE

Description Sets/reads questionable-power status enable register

Variable

	<Long>
Range	0 to 65535
Preset value	0
Unit	-
Resolution	-

Equivalent key No equivalent key is available on the front panel.

**SCPI.STATus.QUEStionable.POWER.EVENT**

Syntax <long> = SCPI.STATus.QUEStionable.POWER.EVENT

Description Reads questionable-power status event register value (Read Only)

Equivalent key No equivalent key is available on the front panel.

## **SCPI.STATus.QUEStionable.PTRansition**

Syntax SCPI.STATus.QUEStionable.PTRansition = <long>  
<long> = SCPI.STATus.QUEStionable.PTRansition

Description Sets/reads questionable status positive transition filter value

Variable

	<b>&lt;Long&gt;</b>
Range	0 to 65535
Preset value	32767
Unit	-
Resolution	-

Equivalent key No equivalent key is available on the front panel.

## **SCPI.STATus.QUEStionable.REFerence.ENABLE**

Syntax SCPI.STATus.QUEStionable.REFerence.ENABLE = <long>  
<long> = SCPI.STATus.QUEStionable.REFerence.ENABLE

Description Sets/reads questionable-reference signal status enable register

Variable

	<b>&lt;Long&gt;</b>
Range	0 to 65535
Preset value	0
Unit	-
Resolution	-

Equivalent key No equivalent key is available on the front panel.

## **SCPI.STATus.QUEStionable.REFerence.EVENT**

Syntax <long> = SCPI.STATus.QUEStionable.REFerence.EVENT

Description Reads questionable-reference signal status event register value (Read Only)

Equivalent key No equivalent key is available on the front panel.

## SCPI.SYSTem.BACKlight.STATe

**Syntax** SCPI.SYSTem.BACKlight.STATe = <boolean>  
 <boolean> = SCPI.SYSTem.BACKlight.STATe

**Description** Turns on/off backlight

**Variable**

	<b>Param</b>
True or -1(Preset value)	Turns on the LCD's backlight
False or 0	Turns off the LCD's backlight

**Equivalent key** PN Menu -> System -> Backlight  
 SP Menu -> System -> Backlight  
 FP Menu -> System -> Backlight  
 TR Menu -> System -> Backlight  
 USER Menu -> System -> Backlight

## SCPI.SYSTem.BEEPer.COMPLete.IMMEDIATE

**Syntax** SCPI.SYSTem.BEEPer.COMPLete.IMMEDIATE

**Description** Makes beep sound for operation completion (No Read)

**Equivalent key** PN Menu -> System -> Misc Setup -> Beeper -> Test Beep Complete  
 SP Menu -> System -> Misc Setup -> Beeper -> Test Beep Complete  
 FP Menu -> System -> Misc Setup -> Beeper -> Test Beep Complete  
 TR Menu -> System -> Misc Setup -> Beeper -> Test Beep Complete

## SCPI.SYSTem.BEEPer.COMPLete.STATe

**Syntax** SCPI.SYSTem.BEEPer.COMPLete.STATe = <boolean>  
 <boolean> = SCPI.SYSTem.BEEPer.COMPLete.STATe

**Description** Turns on/off the beep for operation completion

**Variable**

	<b>Param</b>
True or -1(Preset value)	Set the beep for operation completion to 'ON'

	<b>Param</b>
False or 0	Set the beep for operation completion to 'OFF'

Equivalent key PN Menu -> System -> Misc Setup -> Beeper -> Beep Complete  
 SP Menu -> System -> Misc Setup -> Beeper -> Beep Complete  
 FP Menu -> System -> Misc Setup -> Beeper -> Beep Complete  
 TR Menu -> System -> Misc Setup -> Beeper -> Beep Complete  
 USER Menu -> System -> Misc Setup -> Beeper -> Beep Complete

### **SCPI.SYSTem.BEEPer.WARNIing.IMMediate**

Syntax SCPI.SYSTem.BEEPer.WARNIing.IMMediate

Description Makes beep sound for warning (No Read)

Equivalent key PN Menu -> System -> Misc Setup -> Beeper -> Test Beep Warning  
 SP Menu -> System -> Misc Setup -> Beeper -> Test Beep Warning  
 FP Menu -> System -> Misc Setup -> Beeper -> Test Beep Warning  
 TR Menu -> System -> Misc Setup -> Beeper -> Test Beep Warning  
 USER Menu -> System -> Misc Setup -> Beeper -> Test Beep Warning

### **SCPI.SYSTem.BEEPer.WARNIing.STATe**

Syntax SCPI.SYSTem.BEEPer.WARNIing.STATe = <boolean>  
 <boolean> = SCPI.SYSTem.BEEPer.WARNIing.STATe

Description Turns on/off the beep for warning

Variable

	<b>Param</b>
True or -1	Set the beep for warning to 'ON'
False or 0(Preset value)	Set the beep for warning to 'OFF'

Equivalent key PN Menu -> System -> Misc Setup -> Beeper -> Beep Warning  
 SP Menu -> System -> Misc Setup -> Beeper -> Beep Warning  
 FP Menu -> System -> Misc Setup -> Beeper -> Beep Warning  
 TR Menu -> System -> Misc Setup -> Beeper -> Beep Warning  
 USER Menu -> System -> Misc Setup -> Beeper -> Beep Warning



## SCPI.SYSem.DATE[\_Q] year, month, day

Syntax SCPI.SYSem.DATE\_Q year, month, day (Query)  
 SCPI.SYSem.DATE year, month, day (Set)

Description Sets/reads system date

Variable

	<Long >
Range	1980 to 2030
Preset value	-
Unit	-
Resolution	-

	<Long >
Range	1 to 12
Preset value	-
Unit	-
Resolution	-

	<Long >
Range	1 to 31
Preset value	-
Unit	-
Resolution	-

Examples Dim yy As Long  
 Dim mm As Long  
 Dim dd As Long  
  
 SCPI.SYSem.DATE 2004, 6, 1  
 SCPI.SYSem.DATE\_Q yy, mm, dd

Equivalent key No equivalent key is available on the front panel.

## SCPI.SYSem.ERROR.NEXT\_Q err\_no, err\_desc

Syntax SCPI.SYSem.ERROR.NEXT\_Q err\_no, err\_desc

Description Get error code & description (Read Only)

COM Object Reference  
**SCPI.SYSTem.KLOCK.KBD**

Examples           Dim err\_no As long  
                  Dim err\_desc As String  
  
                  SCPI.SYSTem.ERROR.NEXT\_Q err\_no, err\_desc

Equivalent key    No equivalent key is available on the front panel.

**SCPI.SYSTem.KLOCK.KBD**

Syntax            SCPI.SYSTem.KLOCK.KBD = <boolean>  
                  <boolean> = SCPI.SYSTem.KLOCK.KBD

Description       Sets/reads front panel and keyboard lock state

Variable

	<b>Param</b>
True or -1	Set front panel and keyboard lock state to 'ON'
False or 0(Preset value)	Set front panel and keyboard lock state to 'OFF'

Equivalent key    No equivalent key is available on the front panel.

**SCPI.SYSTem.KLOCK.MOUSe**

Syntax            SCPI.SYSTem.KLOCK.MOUSe = <boolean>  
                  <boolean> = SCPI.SYSTem.KLOCK.MOUSe

Description       Set/Get touch screen and mouse lock state

Variable

	<b>Param</b>
True or -1	Set touch screen and mouse lock state to 'ON'
False or 0(Preset value)	Set touch screen and mouse lock state to 'OFF'

Equivalent key    No equivalent key is available on the front panel.

**SCPI.SYSTem.POFF**

Syntax            SCPI.SYSTem.POFF

Description       Power off the instrument (No Read)

Equivalent key    No equivalent key is available on the front panel.

## SCPI.SYSTem.PRESet

Syntax	SCPI.SYSTem.PRESet
Description	Preset instrument state. same as '*RST;:INIT:instr:CONT ON'(instr' is all instrument). (No Read)
Equivalent key	No equivalent key is available on the front panel.

## SCPI.SYSTem.TIME[\_Q] hour, minute, second

Syntax	SCPI.SYSTem.TIME_Q hour, minute, second (Query) SCPI.SYSTem.TIME hour, minute, second (Set)
Description	Sets/reads system time
Variable	

	<Long >
Range	0 to 23
Preset value	-
Unit	-
Resolution	-

	<Long >
Range	0 to 59
Preset value	-
Unit	-
Resolution	-

	<Long >
Range	0 to 59
Preset value	-
Unit	-
Resolution	-

Examples	Dim hh As Long Dim mm As Long Dim ss As Long  SCPI.SYSTem.TIME 18, 25, 40
----------	---

COM Object Reference  
**SCPI.TRIGger.EXTERNAL.SLOPe**

SCPI.SYSTem.TIME\_Q hh, mm, ss

Equivalent key No equivalent key is available on the front panel.

**SCPI.TRIGger.EXTERNAL.SLOPe**

Syntax SCPI.TRIGger.EXTERNAL.SLOPe = <string>  
 <string> = SCPI.TRIGger.EXTERNAL.SLOPe

Description External trigger polarity

Variable

	Param
NEGative(Preset value)	Set External trigger polarity to 'NEGative'
POSitive	Set External trigger polarity to 'POSitive'

Equivalent key PN Menu -> Trigger -> Ext Trig Polarity  
 SP Menu -> Trigger -> Ext Trig Polarity  
 FP Menu -> Trigger -> Ext Trig Polarity  
 TR Menu -> Trigger -> Ext Trig Polarity

**SCPI.TRIGger.FP(1-1).MODE**

Syntax SCPI.TRIGger.FP(1-1).MODE = <string>  
 <string> = SCPI.TRIGger.FP(1-1).MODE

Description Sets/reads the trigger mode in the frequency, power, and DC current mode

Variable\*1

	Param
ANALyzer(Preset value)	Set trigger mode to 'ANALyzer'
TESTer	Set trigger mode to 'TESTer'

Equivalent key\*2 FP Menu -> Trigger -> Mode

\*1. "Option not installed" error message is generated when setting the trigger mode to the analyzer mode with the option 011 instrument.

\*2. The softkey is not available when option 011 is installed.

## SCPI.TRIGger.FP(1-1).SOURce

**Syntax** SCPI.TRIGger.FP(1-1).SOURce = <string>  
 <string> = SCPI.TRIGger.FP(1-1).SOURce

**Description** Selects trigger source

**Variable**

	<b>Param</b>
INTernal(Preset value)	Set trigger source to 'INTernal'
EXTernal	Set trigger source to 'EXTernal'
MANual	Set trigger source to 'MANual'
BUS	Set trigger source to 'BUS'

**Equivalent key** FP Menu -> Trigger -> Source

## SCPI.TRIGger.MODE

**Syntax** SCPI.TRIGger.MODE = <string>  
 <string> = SCPI.TRIGger.MODE

**Description** Selects the active measurement mode

**Variable**

	<b>Param</b>
PN1(Preset value)	Set measurement mode to 'PN1'
SP1	Set measurement mode to 'SP1'
FP1	Set measurement mode to 'FP1'
TR1	Set measurement mode to 'TR1'

**Equivalent key** PN Menu -> Trigger -> Trigger to Phase Noise  
 SP Menu -> Trigger -> Trigger to Spectrum Monitor  
 FP Menu -> Trigger -> Trigger to Freq & Power  
 TR Menu -> Trigger -> Trigger to Transient

## SCPI.TRIGger.PN(1-1).SOURce

**Syntax** SCPI.TRIGger.PN(1-1).SOURce = <string>

COM Object Reference  
**SCPI.TRIGger.SP(1-1).SOURce**

<string> = SCPI.TRIGger.PN(1-1).SOURce

Description Selects trigger source

Variable

	<b>Param</b>
INTernal(Preset value)	Set trigger source to 'INTernal'
EXTernal	Set trigger source to 'EXTernal'
MANual	Set trigger source to 'MANual'
BUS	Set trigger source to 'BUS'

Equivalent key PN Menu -> Trigger -> Source

**SCPI.TRIGger.SP(1-1).SOURce**

Syntax SCPI.TRIGger.SP(1-1).SOURce = <string>

<string> = SCPI.TRIGger.SP(1-1).SOURce

Description Selects trigger source

Variable

	<b>Param</b>
INTernal(Preset value)	Set trigger source to 'INTernal'
EXTernal	Set trigger source to 'EXTernal'
MANual	Set trigger source to 'MANual'
BUS	Set trigger source to 'BUS'

Equivalent key SP Menu -> Trigger -> Source

**SCPI.TRIGger.TR(1-1).NARRow.VIDeo.FREQuency.CENTer**

Syntax SCPI.TRIGger.TR(1-1).NARRow.VIDeo.FREQuency.CENTer = <double>

<double> = SCPI.TRIGger.TR(1-1).NARRow.VIDeo.FREQuency.CENTer

Description Sets/reads the video trigger frequency value in teh narrowband mode

Variable

	<b>&lt;Double&gt;</b>
Range	9.2M to 7.0128G
Preset value	1G
Unit	Hz
Resolution	-

Equivalent key TR Menu -> Setup -> Video Trigger -> Narrow Freq

### **SCPI.TRIGger.TR(1-1).NARRow.VIDeo.THReshold**

Syntax SCPI.TRIGger.TR(1-1).NARRow.VIDeo.THReshold = <double>  
 <double> = SCPI.TRIGger.TR(1-1).NARRow.VIDeo.THReshold

Description Sets/reads video trigger threshold level relative to max input level

Variable

	<b>&lt;Double&gt;</b>
Range	-100 to 0
Preset value	-20
Unit	dB
Resolution	1

Equivalent key TR Menu -> Setup -> Video Trigger -> Minimum Power Level

### **SCPI.TRIGger.TR(1-1).SOURce**

Syntax SCPI.TRIGger.TR(1-1).SOURce = <string>  
 <string> = SCPI.TRIGger.TR(1-1).SOURce

Description Selects trigger source

Variable

	<b>Param</b>
INTernal(Preset value)	Set trigger source to 'INTernal'
EXTernal	Set trigger source to 'EXTernal'
MANual	Set trigger source to 'MANual'

	<b>Param</b>
BUS	Set trigger source to 'BUS'
WVIDeo	Set trigger source to 'WVIDeo'
NVIDeo	Set trigger source to 'NVIDeo'

Equivalent key TR Menu -> Trigger -> Source

### **SCPI.TRIGger.TR(1-1).WIDE.VIDeo.FREQuency.CENTer**

Syntax SCPI.TRIGger.TR(1-1).WIDE.VIDeo.FREQuency.CENTer = <double>  
<double> = SCPI.TRIGger.TR(1-1).WIDE.VIDeo.FREQuency.CENTer

Description Sets/reads the video trigger frequency value in the wideband mode

Variable

	<b>&lt;Double&gt;</b>
Range	50M to 7.2G
Preset value	1G
Unit	Hz
Resolution	-

Equivalent key TR Menu -> Setup -> Video Trigger -> Wide Freq



## COM Object List

### List by function

Bellow table shows the COM object list by function.

Function	Setting/Execution item	COM object
24Bit I/O control	Outputs data using port A	SCPI.CONTRol.HANDler.A.DATA
	Outputs data using port B	SCPI.CONTRol.HANDler.B.DATA
	Inputs/Outputs data using port C	SCPI.CONTRol.HANDler.C.DATA
	Selects input/output mode on port C	SCPI.CONTRol.HANDler.C.MODE
	Inputs/Outputs data using port D	SCPI.CONTRol.HANDler.D.DATA
	Selects input/output mode on port D	SCPI.CONTRol.HANDler.D.MODE
	Inputs/outputs data using port E(port C + port D; 16 bits)	SCPI.CONTRol.HANDler.E.DATA
	Inputs/outputs data using port F(port A + port C; 16 bits)	SCPI.CONTRol.HANDler.F.DATA
	Sets/Reads OUTPUT1 and/or OUTPUT2	SCPI.CONTRol.HANDler.OUTPUT(1-2).DATA
Auto Frequency Control	Turns on/off the auto frequency control function	SCPI.SOURce.VOLTage.CONTRol.AFC.STATe
	Executes the auto frequency control once.	SCPI.SOURce.VOLTage.CONTRol.AFC.IMMediate
	Sets/reads the frequency band in the auto frequency control function	SCPI.SOURce.VOLTage.CONTRol.AFC.FBAND
	Sets/reads the maximum number of iterations for the DC control voltage-setting loops	SCPI.SOURce.VOLTage.CONTRol.AFC.ITERation
	Sets/reads the maximum DC control voltage limit	SCPI.SOURce.VOLTage.CONTRol.AFC.LIMit.HIGH
	Sets/reads the minimum DC control voltage limit	SCPI.SOURce.VOLTage.CONTRol.AFC.LIMit.LOW
	Sets/reads the tuning sensitivity	SCPI.SOURce.VOLTage.CONTRol.AFC.SENSitivity
	Sets/reads the target frequency in the auto frequency control function	SCPI.SOURce.VOLTage.CONTRol.AFC.TARGet
	Sets/reads the tolerance limit	SCPI.SOURce.VOLTage.CONTRol.AFC.TOLerance
Beeper	Makes beep sound for operation completion	SCPI.SYStem.BEEPPer.COMPLete.IMMediate
	Turns on/off the beep for operation completion	SCPI.SYStem.BEEPPer.COMPLete.STATe
	Makes beep sound for warning	SCPI.SYStem.BEEPPer.WARNing.IMMediate
	Turns on/off the beep for warning	SCPI.SYStem.BEEPPer.WARNing.STATe
DC sources	Execute DC CTRL DRIFT CAL	SCPI.SOURce.VOLTage.CONTRol.CORRection.COLLe ct.ACQuire
	DC CTRL DRIFT CAL state	SCPI.SOURce.VOLTage.CONTRol.CORRection.STATe
	Src Control setting delay(sec)	SCPI.SOURce.VOLTage.CONTRol.DELay

COM Object Reference  
List by function

Function	Setting/Execution item	COM object
DC sources (Continued)	fixed Vcontrol value at Vpower sweep	SCPI.SOURce.VOLTage.CONTRol.LEVel.AMPLitude
	fixed Vcontrol On/Off at Vpower sweep	SCPI.SOURce.VOLTage.CONTRol.LEVel.STATe
	fixed Vcontrol high limit, Resolution 0.1mV	SCPI.SOURce.VOLTage.CONTRol.LIMit.HIGH
	fixed Vcontrol low limit, Resolution 0.1mdV	SCPI.SOURce.VOLTage.CONTRol.LIMit.LOW
	Src Power setting delay(sec)	SCPI.SOURce.VOLTage.POWer.DELay
	fixed Vpower value at Vcontrol sweep	SCPI.SOURce.VOLTage.POWer.LEVel.AMPLitude
	fixed Vpower On/Off at Vcontrol sweep	SCPI.SOURce.VOLTage.POWer.LEVel.STATe
	fixed Vpower high limit, Resolution 1mV	SCPI.SOURce.VOLTage.POWer.LIMit.HIGH
	fixed Vpower low limit, Resolution 1mdV	SCPI.SOURce.VOLTage.POWer.LIMit.LOW
Display	Turns on/off internal clock display	SCPI.DISPlay.CLOCK
	Adds texts in echo window	SCPI.DISPlay.ECHO.ADD
	Clears echo window	SCPI.DISPlay.ECHO.CLEAr
	text in echo window. accept LineFeed(0x0a, vbLF) character. Other non-printable characters will be converted to a space charcter.	SCPI.DISPlay.ECHO.DATA
	font size in echo window	SCPI.DISPlay.ECHO.FSIZE
	Show/Hide echo window	SCPI.DISPlay.ECHO.STATe
	Enable/disable trace update	SCPI.DISPlay.ENABLE
	maximize active instrument window	SCPI.DISPlay.MAXimize
	Show/Hide soft key	SCPI.DISPlay.SKEY.STATe
	Update display force	SCPI.DISPlay.UPDate.IMMEDIATE
	set the specified window visible and active	SCPI.DISPlay.WINDow.ACTive
File operation	Catalog directory	SCPI.MMEMory.CATalog_Q dir, list
	Copy file	SCPI.MMEMory.COPY src, dst
	file transfer through SCPI	SCPI.MMEMory.DATA[_Q] file, data
	Delete file/directory	SCPI.MMEMory.DELete
	Loads program	SCPI.MMEMory.LOAD.PROGRAM
	Recalls settings	SCPI.MMEMory.LOAD.STATe
	Creates a directory	SCPI.MMEMory.MDIRectory
	Save screen image	SCPI.MMEMory.STORe.IMAGe
	Save VBA project	SCPI.MMEMory.STORe.PROGRAM
	Save settings	SCPI.MMEMory.STORe.STATe
	Select save state type	SCPI.MMEMory.STORe.STYPE

Function	Setting/Execution item	COM object
Frequency, RF power and DC current measurement - Display	Selects active trace	SCPI.CALCulate.FP(1-1).ALLTrace.ACTive
	Data hold	SCPI.CALCulate.FP(1-1).TRACe(1-4).HOLD
	Sets/reads math operation type	SCPI.CALCulate.FP(1-1).TRACe(1-4).MATH.FUNcTION
	Copy data to memory	SCPI.CALCulate.FP(1-1).TRACe(1-4).MATH.MEMorize
	Sensitivity Aperture	SCPI.CALCulate.FP(1-1).TRACe(1-4).SAPerture
	Smoothing aperture	SCPI.CALCulate.FP(1-1).TRACe(1-4).SMOothing.APErture
	Turns on/off smoothing function	SCPI.CALCulate.FP(1-1).TRACe(1-4).SMOothing.STATe
	Clears all stored traces	SCPI.DISPlay.FP(1-1).ALLTrace.PERSistence.CLEar
	Execute autoscale all	SCPI.DISPlay.FP(1-1).ALLTrace.Y.SCALe.AUTO
	Turns on/off measurement conditions	SCPI.DISPlay.FP(1-1).ANNotation.MEASurement.STATe
	Turns on/off relative Y-scale	SCPI.DISPlay.FP(1-1).GRATicule.AXIS.Y.RELative
	Show/Hide Y graticule label	SCPI.DISPlay.FP(1-1).GRATicule.AXIS.Y.STATe
	Window title label	SCPI.DISPlay.FP(1-1).LABel.DATA
	Show/Hide Window Title Label	SCPI.DISPlay.FP(1-1).LABel.STATe
	maximize active trace	SCPI.DISPlay.FP(1-1).MAXimize
	measurement display on/off. At least one meas window must be turned on.	SCPI.DISPlay.FP(1-1).STATe
	Edits trace title label	SCPI.DISPlay.FP(1-1).TRACe(1-4).LABel.DATA
	Shows data and/or memory trace	SCPI.DISPlay.FP(1-1).TRACe(1-4).MODE
	Clears persistence mode	SCPI.DISPlay.FP(1-1).TRACe(1-4).PERSistence.CLEar
	Sets/reads persistence mode	SCPI.DISPlay.FP(1-1).TRACe(1-4).PERSistence.STATe
	Execute autoscale	SCPI.DISPlay.FP(1-1).TRACe(1-4).Y.SCALe.AUTO
	Sets/reads scale per division	SCPI.DISPlay.FP(1-1).TRACe(1-4).Y.SCALe.PDIVision
	Sets/reads scale reference level	SCPI.DISPlay.FP(1-1).TRACe(1-4).Y.SCALe.RLEVel
	Sets/reads scale reference position	SCPI.DISPlay.FP(1-1).TRACe(1-4).Y.SCALe.RPOSition
	Sets/reads number of Y division	SCPI.DISPlay.FP(1-1).Y.SCALe.DIVisions
	Copies trace data to the user trace	SCPI.CALCulate.FP(1-1).TRACe(1-4).DATA.COPY
	Sets/reads the trace layout	SCPI.DISPlay.FP(1-1).SPLit
	FP-frequency format	SCPI.CALCulate.FP(1-1).TRACe(1-4).FORMat.FREQuency
	Sets/reads the frequency reference.	SCPI.CALCulate.FP(1-1).TRACe(1-4).REFerence.FREQUency
	Reads the trace parmeter.	SCPI.CALCulate.FP(1-1).TRACe(1-4).PARAmeter

COM Object Reference  
List by function

Function	Setting/Execution item	COM object
Frequency, RF power and DC current measurement - File operation	Saves trace data	SCPI.MMEMory.FP(1-1).TRACe(1-4).STORe.DATA
	Saves memory trace data	SCPI.MMEMory.FP(1-1).TRACe(1-4).STORe.MEMory
Frequency, RF power and DC current measurement - Limit Test	Reads out the limit test result	SCPI.CALCulate.FP(1-1).ALLTrace.LIMit.FAIL
	Turns on/off the limit test function	SCPI.CALCulate.FP(1-1).TRACe(1-4).LIMit.STATe
	Sets/reads the number of segments in the upper limit line	SCPI.CALCulate.FP(1-1).TRACe(1-4).LIMit.UPPer.SEGMent.COUNt
	Sets/reads the number of segments in the lower limit line	SCPI.CALCulate.FP(1-1).TRACe(1-4).LIMit.LOWer.SEGMent.COUNt
	Sets/reads segment data of the upper limit line	SCPI.CALCulate.FP(1-1).TRACe(1-4).LIMit.UPPer.SEGMent.DATA
	Sets/reads segment data of the lower limit line	SCPI.CALCulate.FP(1-1).TRACe(1-4).LIMit.LOWer.SEGMent.DATA
	Clears the upper limit line	SCPI.CALCulate.FP(1-1).TRACe(1-4).LIMit.UPPer.SEGMent.CLEar
	Clears the lower limit line	SCPI.CALCulate.FP(1-1).TRACe(1-4).LIMit.LOWer.SEGMent.CLEar
	Sets/reads the upper limit values of all measurement points	SCPI.CALCulate.FP(1-1).TRACe(1-4).LIMit.UPPer.LDAta
	Sets/reads the lower limit values of all measurement points	SCPI.CALCulate.FP(1-1).TRACe(1-4).LIMit.LOWer.LDAta
	Reads out the limit test result	SCPI.CALCulate.FP(1-1).TRACe(1-4).LIMit.FAIL
	Reads the limit test results of all measurement points in selected traces	SCPI.CALCulate.FP(1-1).TRACe(1-4).LIMit.REPort.DATa
	Turns on/off the limit line	SCPI.DISPlay.FP(1-1).TRACe(1-4).LIMit.LINE
	Turns on/off the limit test judgement display	SCPI.DISPlay.FP(1-1).LIMit.FSIGN
	Reads the upper limit line	SCPI.MMEMory.FP(1-1).TRACe(1-4).LOAD.LIMit.UPPer
	Reads the lower limit line	SCPI.MMEMory.FP(1-1).TRACe(1-4).LOAD.LIMit.LOWer
Frequency, RF power and DC current measurement - Marker/analysis	Turns on/off bandmarker coupling function	SCPI.CALCulate.FP(1-1).ALLTrace.BDMarker.X.COUPle.STATe
	Turns on/of marker coupling function	SCPI.CALCulate.FP(1-1).ALLTrace.MARKer.COUPle.STATe
	Sets/reads marker movement (Continuous/Discrete)	SCPI.CALCulate.FP(1-1).ALLTrace.MARKer.DISCrete.STATe
	Sets/reads marker reference number	SCPI.CALCulate.FP(1-1).ALLTrace.MARKer.REFerence.NUMBer
	Turns on/off delta marker mode	SCPI.CALCulate.FP(1-1).ALLTrace.MARKer.REFerence.STATe
	Selects active marker	SCPI.CALCulate.FP(1-1).TRACe(1-4).ALLMarker.ACTive

Function	Setting/Execution item	COM object
Frequency, RF power and DC current measurement - Marker/analysis (Continued)	Sets/reads marker search range (X-axis)	SCPI.CALCulate.FP(1-1).TRACe(1-4).ALLMarker.SEA Rch.DOMain.X
	Sets/reads marker search range (Y-axis)	SCPI.CALCulate.FP(1-1).TRACe(1-4).ALLMarker.SEA Rch.DOMain.Y
	Execute marker search all	SCPI.CALCulate.FP(1-1).TRACe(1-4).ALLMarker.SEA Rch.PEAK
	Sets/reads the center value of bandmarker X	SCPI.CALCulate.FP(1-1).TRACe(1-4).BDMarker.X.CE NTer
	Sets/reads the span value of bandmarker X	SCPI.CALCulate.FP(1-1).TRACe(1-4).BDMarker.X.SPA N
	Sets/reads the start value of bandmarker X	SCPI.CALCulate.FP(1-1).TRACe(1-4).BDMarker.X.STA Rt
	Turns on/off bandmarker X	SCPI.CALCulate.FP(1-1).TRACe(1-4).BDMarker.X.STA Te
	Sets/reads the stop value of bandmarker X	SCPI.CALCulate.FP(1-1).TRACe(1-4).BDMarker.X.ST OP
	Sets/reads the center value of bandmarker Y	SCPI.CALCulate.FP(1-1).TRACe(1-4).BDMarker.Y.CE NTer
	Sets/reads the span value of bandmarker Y	SCPI.CALCulate.FP(1-1).TRACe(1-4).BDMarker.Y.SPA N
	Sets/reads the start value of bandmarker Y	SCPI.CALCulate.FP(1-1).TRACe(1-4).BDMarker.Y.STA Rt
	Turns on/off bandmarker Y	SCPI.CALCulate.FP(1-1).TRACe(1-4).BDMarker.Y.STA Te
	Sets/reads the stop value of bandmarker Y	SCPI.CALCulate.FP(1-1).TRACe(1-4).BDMarker.Y.STO P
	Sets/reads analysis/search range (X-axis)	SCPI.CALCulate.FP(1-1).TRACe(1-4).FUNctio.n.DOMa in.X
	Sets/reads analysis/search range (Y-axis)	SCPI.CALCulate.FP(1-1).TRACe(1-4).FUNctio.n.DOMa in.Y
	Reads the results of statistical analysis for the data trace	SCPI.CALCulate.FP(1-1).TRACe(1-4).FUNctio.n.STATI stics.DATA_Q mean, std_dev, peak_to_peak
	Reads the results of statistical analysis for the memory trace	SCPI.CALCulate.FP(1-1).TRACe(1-4).FUNctio.n.STATI stics.MEMory_Q mean, std_dev, peak_to_peak
	Sets/reads analysis type	SCPI.CALCulate.FP(1-1).TRACe(1-4).FUNctio.n.TYPE
	Execute marker peak search left	SCPI.CALCulate.FP(1-1).TRACe(1-4).MARKer(1-6).SE ARch.EXECute.LPEak
	Execute marker target search left	SCPI.CALCulate.FP(1-1).TRACe(1-4).MARKer(1-6).SE ARch.EXECute.LTARget
	Execute marker search maximum	SCPI.CALCulate.FP(1-1).TRACe(1-4).MARKer(1-6).SE ARch.EXECute.MAXimum
	Execute marker search minimum	SCPI.CALCulate.FP(1-1).TRACe(1-4).MARKer(1-6).SE ARch.EXECute.MINimum

COM Object Reference  
List by function

Function	Setting/Execution item	COM object
Frequency, RF power and DC current measurement - Marker/analysis (Continued)	Execute marker peak search	SCPI.CALCulate.FP(1-1).TRACe(1-4).MARKer(1-6).SEARch.EXECute.PEAK
	Execute marker peak search right	SCPI.CALCulate.FP(1-1).TRACe(1-4).MARKer(1-6).SEARch.EXECute.RPEak
	Execute marker target search right	SCPI.CALCulate.FP(1-1).TRACe(1-4).MARKer(1-6).SEARch.EXECute.RTARget
	Execute marker target search	SCPI.CALCulate.FP(1-1).TRACe(1-4).MARKer(1-6).SEARch.EXECute.TARGet
	Sets/reads the peak excursion value	SCPI.CALCulate.FP(1-1).TRACe(1-4).MARKer(1-6).SEARch.PEAK.EXCursion
	Sets/reads the marker peak-search polarity	SCPI.CALCulate.FP(1-1).TRACe(1-4).MARKer(1-6).SEARch.PEAK.POLarity
	Sets/reads the target transition definition	SCPI.CALCulate.FP(1-1).TRACe(1-4).MARKer(1-6).SEARch.TARGet.TRANSition
	Sets/reads the marker target value	SCPI.CALCulate.FP(1-1).TRACe(1-4).MARKer(1-6).SEARch.TARGet.Y
	Sets/reads the marker tracking type	SCPI.CALCulate.FP(1-1).TRACe(1-4).MARKer(1-6).SEARch.TRACKing.TYpe
	Turns on/off markers	SCPI.CALCulate.FP(1-1).TRACe(1-4).MARKer(1-6).STATe
	Sets/reads the marker X value	SCPI.CALCulate.FP(1-1).TRACe(1-4).MARKer(1-6).X
	Reads the marker Y value	SCPI.CALCulate.FP(1-1).TRACe(1-4).MARKer(1-6).Y
	Sets/reads the marker information position	SCPI.DISPlay.FP(1-1).ANNOtation.MARKer.POSition
	Turns on/off the marker list	SCPI.DISPlay.FP(1-1).TABLe.STATe
Frequency, RF power and DC current measurement - Measurement	always move to waiting-for-trigger state after measuring	SCPI.INITiate.FP(1-1).CONTinuous
	move once to waiting-for-trigger state	SCPI.INITiate.FP(1-1).IMMediate
	trigger mode (Not available when option 011 is installed)	SCPI.TRIGger.FP(1-1).MODE
	trigger source	SCPI.TRIGger.FP(1-1).SOURce
Frequency, RF power and DC current measurement - Measurement conditions	Restart averaging	SCPI.SENSE.FP(1-1).AVERAge.CLEar
	Sets/reads averaging count	SCPI.SENSE.FP(1-1).AVERAge.COUNt
	Turns on/off averaging function	SCPI.SENSE.FP(1-1).AVERAge.STATe
	Selects frequency band	SCPI.SENSE.FP(1-1).FBANd
	Sets/reads frequency resolution	SCPI.SENSE.FP(1-1).FREQUency.RESolution
	Sets/reads the point delay value	SCPI.SENSE.FP(1-1).SWEep.DWELl
	Sets/reads sweep parameter	SCPI.SOURce.FP(1-1).SWEep.PARAmeter
	Sets/reads the number of measurement points	SCPI.SOURce.FP(1-1).SWEep.POINts
Vcontrol center	SCPI.SOURce.FP(1-1).VOLTage.CONTRol.CENTer	

Function	Setting/Execution item	COM object
Frequency, RF power and DC current measurement - Measurement conditions (Continued)	Vcontrol span	SCPI.SOURce.FP(1-1).VOLTage.CONTRol.SPAN
	Vcontrol start	SCPI.SOURce.FP(1-1).VOLTage.CONTRol.STARt
	Vcontrol stop	SCPI.SOURce.FP(1-1).VOLTage.CONTRol.STOP
	Vpower center	SCPI.SOURce.FP(1-1).VOLTage.POWer.CENTer
	Vpower span	SCPI.SOURce.FP(1-1).VOLTage.POWer.SPAN
	Vpower start	SCPI.SOURce.FP(1-1).VOLTage.POWer.STARt
	Vpower stop	SCPI.SOURce.FP(1-1).VOLTage.POWer.STOP
Frequency, RF power and DC current measurement - Reads/writes the data	Sets/reads raw data	SCPI.CALCulate.FP(1-1).DATA.RDATA
	Sets/reads tester mode data	SCPI.CALCulate.FP(1-1).DATA.TDATA
	Reads X-axis data	SCPI.CALCulate.FP(1-1).DATA.XDATA
	Set/Get formatted trace data	SCPI.CALCulate.FP(1-1).TRACe(1-4).DATA.FDATA
	Set/Get formatted memory data	SCPI.CALCulate.FP(1-1).TRACe(1-4).DATA.FMEMory
	Set/Get unformatted trace data	SCPI.CALCulate.FP(1-1).TRACe(1-4).DATA.UDATA
	Set/Get unformatted memory data	SCPI.CALCulate.FP(1-1).TRACe(1-4).DATA.UMEMory
	Reads the measurement time	SCPI.SENSE.FP(1-1).SWEep.TIME.DATA
Internal clock	Set/Get system date	SCPI.SYSTem.DATE[_Q] year, month, day
	Set/Get system time	SCPI.SYSTem.TIME[_Q] hour, minute, second
Measurement	Abort measurement	SCPI.ABORt
	BUS Trigger	SCPI.IEEE4882.TRG
	Input Attenuator level on 5dB Step	SCPI.SENSE.ATTenuation.LEVel
	External trigger polarity	SCPI.TRIGger.EXTernal.SLOPe
	select measurement mode	SCPI.TRIGger.MODE
Operations	Set/Get front panel and keyboard lock state	SCPI.SYSTem.KLOCK.KBD
	Set/Get touch screen and mouse lock state	SCPI.SYSTem.KLOCK.MOUSE
Others	Clear caution/message	SCPI.DISPlay.MESSAge.CLEAr
	Reads product model information	SCPI.IEEE4882.IDN
	Reads option information	SCPI.IEEE4882.OPT
	Preset	SCPI.IEEE4882.RST
	Get source of reference oscillator	SCPI.SENSE.ROSCillator.SOURce
	Turns on/off backlight	SCPI.SYSTem.BACKlight.STATE
	Get error code & description	SCPI.SYSTem.ERROR.NEXT_Q err_no, err_desc
	Power off the instrument	SCPI.SYSTem.POFF
	Preset instrument state. same as *RST::INIT:instr:CONT ON('instr' is all instrument).	SCPI.SYSTem.PRESet

COM Object Reference  
List by function

Function	Setting/Execution item	COM object
Phase noise measurement - Display	data hold	SCPI.CALCulate.PN(1-1).TRACe(1-1).HOLD
	Selects math operation type	SCPI.CALCulate.PN(1-1).TRACe(1-1).MATH.FUNcTio n
	Copy data to memory	SCPI.CALCulate.PN(1-1).TRACe(1-1).MATH.MEMoriz e
	Smoothing aperture	SCPI.CALCulate.PN(1-1).TRACe(1-1).SMOothing.APE Rture
	Smoothing on/off	SCPI.CALCulate.PN(1-1).TRACe(1-1).SMOothing.STA Te
	Spurious display omission ON/OFF	SCPI.CALCulate.PN(1-1).TRACe(1-1).SPURious.OMIS sion
	Clears all persistent traces	SCPI.DISPlay.PN(1-1).ALLTrace.PERSistence.CLEar
	Turns on/off measurement conditions	SCPI.DISPlay.PN(1-1).ANNotation.MEASurement.STA Te
	force graticule label notation relative. If OFF, absolute notaion is used if possible.	SCPI.DISPlay.PN(1-1).GRATICule.AXIS.Y.RELative
	Show/Hide Y graticule label	SCPI.DISPlay.PN(1-1).GRATICule.AXIS.Y.STATe
	Edits window title label	SCPI.DISPlay.PN(1-1).LABel.DATA
	Show/Hide Window Title Label	SCPI.DISPlay.PN(1-1).LABel.STATe
	maximize active trace	SCPI.DISPlay.PN(1-1).MAXimize
	Turns on/off phase noise measurement mode	SCPI.DISPlay.PN(1-1).STATe
	Trace Title Label	SCPI.DISPlay.PN(1-1).TRACe(1-1).LABel.DATA
	show data and/or memory trace	SCPI.DISPlay.PN(1-1).TRACe(1-1).MODE
	Clears persistent data	SCPI.DISPlay.PN(1-1).TRACe(1-1).PERSistence.CLEar
	Sets/reads persistence mode	SCPI.DISPlay.PN(1-1).TRACe(1-1).PERSistence.STATe
	Execute autoscale	SCPI.DISPlay.PN(1-1).TRACe(1-1).Y.SCALe.AUTO
	scale per division	SCPI.DISPlay.PN(1-1).TRACe(1-1).Y.SCALe.PDIVision
	scale reference level	SCPI.DISPlay.PN(1-1).TRACe(1-1).Y.SCALe.RLEVel
	scale reference position	SCPI.DISPlay.PN(1-1).TRACe(1-1).Y.SCALe.RPOsition
	Sets/reads # of Y division	SCPI.DISPlay.PN(1-1).Y.SCALe.DIVisions
Copies trace data to the user trace	SCPI.CALCulate.PN(1-1).TRACe(1-1).DATA.COPIY	
Phase noise measurement - File operation	Saves trace data	SCPI.MMEMory.PN(1-1).TRACe(1-1).STORe.DATA
	Saves memory trace data	SCPI.MMEMory.PN(1-1).TRACe(1-1).STORe.MEMory
Phase noise measurement - Limit Test	Reads out the limit test result	SCPI.CALCulate.PN(1-1).ALLTrace.LIMit.FAIL
	Turns on/off the limit test function	SCPI.CALCulate.PN(1-1).TRACe(1-1).LIMit.STATe
	Sets/reads the number of segments in the upper limit line	SCPI.CALCulate.PN(1-1).TRACe(1-1).LIMit.UPPer.SE GMent.COUNT



Function	Setting/Execution item	COM object
Phase noise measurement - Limit Test (Continued)	Sets/reads the number of segments in the lower limit line	SCPI.CALCulate.PN(1-1).TRACe(1-1).LIMit.LOWer.SEGMent.COUNT
	Sets/reads segment data of the upper limit line	SCPI.CALCulate.PN(1-1).TRACe(1-1).LIMit.UPPer.SEGMent.DATA
	Sets/reads segment data of the lower limit line	SCPI.CALCulate.PN(1-1).TRACe(1-1).LIMit.LOWer.SEGMent.DATA
	Clears the upper limit line	SCPI.CALCulate.PN(1-1).TRACe(1-1).LIMit.UPPer.SEGMent.CLEar
	Clears the lower limit line	SCPI.CALCulate.PN(1-1).TRACe(1-1).LIMit.LOWer.SEGMent.CLEar
	Sets/reads the upper limit values of all measurement points	SCPI.CALCulate.PN(1-1).TRACe(1-1).LIMit.UPPer.LDATA
	Sets/reads the lower limit values of all measurement points	SCPI.CALCulate.PN(1-1).TRACe(1-1).LIMit.LOWer.LDATA
	Reads out the limit test result	SCPI.CALCulate.PN(1-1).TRACe(1-1).LIMit.FAIL
	Reads the limit test results of all measurement points in selected traces	SCPI.CALCulate.PN(1-1).TRACe(1-1).LIMit.REPOrt.DATA
	Turns on/off the limit line	SCPI.DISPlay.PN(1-1).TRACe(1-1).LIMit.LINE
	Turns on/off the limit test judgement display	SCPI.DISPlay.PN(1-1).LIMit.FSIGN
	Reads the upper limit line	SCPI.MMEMory.PN(1-1).TRACe(1-1).LOAD.LIMit.UPPer
	Reads the lower limit line	SCPI.MMEMory.PN(1-1).TRACe(1-1).LOAD.LIMit.LOWer
	Phase noise measurement - Marker/analysis	Turns on/off marker coupling function
Sets/reads marker movement (Continuous/Discrete)		SCPI.CALCulate.PN(1-1).ALLTrace.MARKer.DISCrete.STATe
Sets/reads marker reference number		SCPI.CALCulate.PN(1-1).ALLTrace.MARKer.REFERenc.e.NUMBer
Turns on/off delta marker mode		SCPI.CALCulate.PN(1-1).ALLTrace.MARKer.REFERenc.e.STATe
Selects active marker		SCPI.CALCulate.PN(1-1).TRACe(1-1).ALLMarker.ACTive
Sets/reads marker search range (X-axis)		SCPI.CALCulate.PN(1-1).TRACe(1-1).ALLMarker.SEA Rch.DOMain.X
Sets/reads marker search range (Y-axis)		SCPI.CALCulate.PN(1-1).TRACe(1-1).ALLMarker.SEA Rch.DOMain.Y
Execute marker search all		SCPI.CALCulate.PN(1-1).TRACe(1-1).ALLMarker.SEA Rch.PEAK
Sets/reads the center value of bandmarker X		SCPI.CALCulate.PN(1-1).TRACe(1-1).BDMarker.X.CE NTer
Sets/reads the span value of bandmarker X		SCPI.CALCulate.PN(1-1).TRACe(1-1).BDMarker.X.SP AN

COM Object Reference  
List by function

Function	Setting/Execution item	COM object
Phase noise measurement - Marker/analysis (Continued)	Sets/reads the start value of bandmarker X	SCPI.CALCulate.PN(1-1).TRACe(1-1).BDMarker.X.STARt
	Turns on/off bandmarker X	SCPI.CALCulate.PN(1-1).TRACe(1-1).BDMarker.X.STATe
	Sets/reads the stop value of bandmarker X	SCPI.CALCulate.PN(1-1).TRACe(1-1).BDMarker.X.STOP
	Sets/reads the center value of bandmarker Y	SCPI.CALCulate.PN(1-1).TRACe(1-1).BDMarker.Y.CENTer
	Sets/reads the span value of bandmarker Y	SCPI.CALCulate.PN(1-1).TRACe(1-1).BDMarker.Y.SPAN
	Sets/reads the start value of bandmarker Y	SCPI.CALCulate.PN(1-1).TRACe(1-1).BDMarker.Y.STARt
	Turns on/off bandmarker Y	SCPI.CALCulate.PN(1-1).TRACe(1-1).BDMarker.Y.STATe
	Sets/reads the stop value of bandmarker Y	SCPI.CALCulate.PN(1-1).TRACe(1-1).BDMarker.Y.STOP
	Sets/reads analysis/search range (X-axis)	SCPI.CALCulate.PN(1-1).TRACe(1-1).FUNction.DOMain.X
	Sets/reads analysis/search range (Y-axis)	SCPI.CALCulate.PN(1-1).TRACe(1-1).FUNction.DOMain.Y
	Reads the results of statistical analysis for the data trace	SCPI.CALCulate.PN(1-1).TRACe(1-1).FUNction.STATistics.DATA_Q mean, std_dev, peak_to_peak
	Reads the results of statistical analysis for the memory trace	SCPI.CALCulate.PN(1-1).TRACe(1-1).FUNction.STATistics.MEMory_Q mean, std_dev, peak_to_peak
	Sets/reads analysis type	SCPI.CALCulate.PN(1-1).TRACe(1-1).FUNction.TYPE
	Execute marker peak search left	SCPI.CALCulate.PN(1-1).TRACe(1-1).MARKer(1-6).SEARch.EXECute.LPEak
	Execute marker target search left	SCPI.CALCulate.PN(1-1).TRACe(1-1).MARKer(1-6).SEARch.EXECute.LTARget
	Execute marker search maximum	SCPI.CALCulate.PN(1-1).TRACe(1-1).MARKer(1-6).SEARch.EXECute.MAXimum
	Execute marker search minimum	SCPI.CALCulate.PN(1-1).TRACe(1-1).MARKer(1-6).SEARch.EXECute.MINimum
	Execute marker peak search	SCPI.CALCulate.PN(1-1).TRACe(1-1).MARKer(1-6).SEARch.EXECute.PEAK
	Execute marker peak search right	SCPI.CALCulate.PN(1-1).TRACe(1-1).MARKer(1-6).SEARch.EXECute.RPEak
	Execute marker target search right	SCPI.CALCulate.PN(1-1).TRACe(1-1).MARKer(1-6).SEARch.EXECute.RTARget
execute marker target search	SCPI.CALCulate.PN(1-1).TRACe(1-1).MARKer(1-6).SEARch.EXECute.TARGet	
Sets/reads the peak excursion value	SCPI.CALCulate.PN(1-1).TRACe(1-1).MARKer(1-6).SEARch.PEAK.EXCursion	

Function	Setting/Execution item	COM object
Phase noise measurement - Marker/analysis (Continued)	Sets/reads the marker peak-search polarity	SCPI.CALCulate.PN(1-1).TRACe(1-1).MARKer(1-6).SEARch.PEAK.POLarity
	Sets/reads the target transition definition	SCPI.CALCulate.PN(1-1).TRACe(1-1).MARKer(1-6).SEARch.TARGet.TRANsition
	Sets/reads the marker target value	SCPI.CALCulate.PN(1-1).TRACe(1-1).MARKer(1-6).SEARch.TARGet.Y
	Sets/reads the marker tracking type	SCPI.CALCulate.PN(1-1).TRACe(1-1).MARKer(1-6).SEARch.TRACKing.TYPE
	Turns on/off markers	SCPI.CALCulate.PN(1-1).TRACe(1-1).MARKer(1-6).STATe
	Sets/reads the marker X value	SCPI.CALCulate.PN(1-1).TRACe(1-1).MARKer(1-6).X
	Reads the marker Y value	SCPI.CALCulate.PN(1-1).TRACe(1-1).MARKer(1-6).Y
	Sets/reads the marker information position	SCPI.DISPlay.PN(1-1).ANNotation.MARKer.POSition
	Turns on/off the marker list	SCPI.DISPlay.PN(1-1).TABLe.STATe
	Reads the integrated phase noise, frequency range, RMS noise, RMS jitter, and residual FM of trace data.	SCPI.CALCulate.PN(1-1).TRACe(1-1).FUNction.INTegral.DATA_Q integ_noise, freq_range, rms_rad, rms_deg, jitter, residual_fm
	Reads the integrated phase noise, frequency range, RMS noise, RMS jitter, and residual FM of memory data.	SCPI.CALCulate.PN(1-1).TRACe(1-1).FUNction.INTegral.MEMory_Q integ_noise, freq_range, rms_rad, rms_deg, jitter, residual_fm
Phase noise measurement - Measurement	always move to waiting-for-trigger state after measuring	SCPI.INITiate.PN(1-1).CONTinuous
	move once to waiting-for-trigger state	SCPI.INITiate.PN(1-1).IMMediate
	trigger source	SCPI.TRIGger.PN(1-1).SOURce
Phase noise measurement - Measurement conditions	Averaging restart	SCPI.SENSE.PN(1-1).AVERage.CLEAr
	Sets/reads the number of averaging	SCPI.SENSE.PN(1-1).AVERage.COUNt
	Turns on/off averaging	SCPI.SENSE.PN(1-1).AVERage.STATe
	Sets/reads the number of correlation (Not available when option 011 is installed)	SCPI.SENSE.PN(1-1).CORRelation.COUNt
	Sets/reads frequency band	SCPI.SENSE.PN(1-1).FBANd
	Sets/reads start frequency (The minimum value is limited down to 10 when option 011 is installed)	SCPI.SENSE.PN(1-1).FREQuency.START
	Sets/reads stop frequency	SCPI.SENSE.PN(1-1).FREQuency.STOP
	Sets/reads IF Gain at 10dB Step (The value is fixed as 10 when option 011 is installed)	SCPI.SENSE.PN(1-1).IFGain
	Sets/readst phase noise Local bandwidth optimization.	SCPI.SENSE.PN(1-1).LOBandwidth

COM Object Reference  
List by function

Function	Setting/Execution item	COM object
Phase noise measurement - Measurement conditions (Continued)	Reads the number of measurement points	SCPI.SENSE.PN(1-1).SWEep.POINts
	Sets/reads the quality level	SCPI.SENSE.PN(1-1).SEGTable.MEASurement.QUALit y
Phase noise measurement - Reads/writes the data	Sets/reads the carrier frequency/power data in phase noise measurement	SCPI.CALCulate.PN(1-1).DATA.CARRier
	Sets/reads the measurement raw data	SCPI.CALCulate.PN(1-1).DATA.RDATA
	Reads the X data	SCPI.CALCulate.PN(1-1).DATA.XDATA
	Set/Get formatted trace data	SCPI.CALCulate.PN(1-1).TRACe(1-1).DATA.FDATA
	Set/Get formatted memory data	SCPI.CALCulate.PN(1-1).TRACe(1-1).DATA.FMEMory
	Set/Get unformatted trace data	SCPI.CALCulate.PN(1-1).TRACe(1-1).DATA.UDATA
	Set/Get unformatted memory data	SCPI.CALCulate.PN(1-1).TRACe(1-1).DATA.UMEMory
Phase noise measurement - Spurious display	Turns on/off the spurious power value display	SCPI.CALCulate.PN(1-1).TRACe(1-1).SPURious.POWe r
	Sets/reads the raw power data (dBc)	SCPI.CALCulate.PN(1-1).DATA.PDATA
	Sets/reads unformatted trace power data (dBc)	SCPI.CALCulate.PN(1-1).TRACe(1-1).DATA.PDATA
	Sets/reads unformatted memory power data (dBc)	SCPI.CALCulate.PN(1-1).TRACe(1-1).DATA.PMEMory
	Reads the spurious judgement results (0/1) of trace data	SCPI.CALCulate.PN(1-1).TRACe(1-1).DATA.SDATA
	Reads the spurious judgement results (0/1) of memory data.	SCPI.CALCulate.PN(1-1).TRACe(1-1).DATA.SMEMory
	Clears the threshold data	SCPI.CALCulate.PN(1-1).TRACe(1-1).SPURious.THRe shold.TABLe.CLEar
	Sets/reads the number of segments in the threshold data	SCPI.CALCulate.PN(1-1).TRACe(1-1).SPURious.THRe shold.TABLe.COUNt
	Sets/reads the threshold data	SCPI.CALCulate.PN(1-1).TRACe(1-1).SPURious.THRe shold.TABLe.DATA
	Reads the threshold data	SCPI.MMEMory.PN(1-1).TRACe(1-1).LOAD.SPURiou s.THRe shold
Print	Aborts printing	SCPI.HCOPy.ABORt
	Selects print mode	SCPI.HCOPy.IMAGe
	Outputs print	SCPI.HCOPy.IMMediate
Reads/writes the data	Sets/reads byte order setting for binary transfer	SCPI.FORMat.BORDeR
	Sets/reads data transfer mode	SCPI.FORMat.DATA
	User defined array data	SCPI.PROGram.VARiable.ARRay(1-10).DATA
	# of points of user defined array	SCPI.PROGram.VARiable.ARRay(1-10).POINts
	User defined 64bit floating variable	SCPI.PROGram.VARiable.DOUBle(1-10)

Function	Setting/Execution item	COM object
Reads/writes the data (Continued)	User defined integer variable	SCPI.PROGram.VARiable.INTeger(1-10)
	User defined string	SCPI.PROGram.VARiable.STRing(1-10)
Spectrum monitor - Display	SP format	SCPI.CALCulate.SP(1-1).TRACe(1-1).FORMat
	data hold	SCPI.CALCulate.SP(1-1).TRACe(1-1).HOLD
	Selects math operation type	SCPI.CALCulate.SP(1-1).TRACe(1-1).MATH.FUNCTion
	Copy data to memory	SCPI.CALCulate.SP(1-1).TRACe(1-1).MATH.MEMorize
	Smoothing aperture	SCPI.CALCulate.SP(1-1).TRACe(1-1).SMOothing.APErture
	Smoothing on/off	SCPI.CALCulate.SP(1-1).TRACe(1-1).SMOothing.STATe
	Clears all persistent traces	SCPI.DISPlay.SP(1-1).ALLTrace.PERSistence.CLEar
	Turns on/off measurement conditions	SCPI.DISPlay.SP(1-1).ANNotation.MEASurement.STATe
	Turns on/off relative Y-scale	SCPI.DISPlay.SP(1-1).GRATICule.AXIS.Y.RELative
	Show/Hide Y graticule label	SCPI.DISPlay.SP(1-1).GRATICule.AXIS.Y.STATe
	Edits window title label	SCPI.DISPlay.SP(1-1).LABel.DATA
	Show/Hide Window Title Label	SCPI.DISPlay.SP(1-1).LABel.STATe
	maximize active trace	SCPI.DISPlay.SP(1-1).MAXimize
	Turns on/off spectrum monitor mode	SCPI.DISPlay.SP(1-1).STATe
	Trace Title Label	SCPI.DISPlay.SP(1-1).TRACe(1-1).LABel.DATA
	show data and/or memory trace	SCPI.DISPlay.SP(1-1).TRACe(1-1).MODE
	Clears persistent data	SCPI.DISPlay.SP(1-1).TRACe(1-1).PERSistence.CLEar
	Sets/reads persistence mode	SCPI.DISPlay.SP(1-1).TRACe(1-1).PERSistence.STATe
	Execute autoscale	SCPI.DISPlay.SP(1-1).TRACe(1-1).Y.SCALe.AUTO
	scale per division	SCPI.DISPlay.SP(1-1).TRACe(1-1).Y.SCALe.PDIVision
	scale reference level	SCPI.DISPlay.SP(1-1).TRACe(1-1).Y.SCALe.RLEVel
	scale reference position	SCPI.DISPlay.SP(1-1).TRACe(1-1).Y.SCALe.RPOSition
	Sets/reads # of Y division	SCPI.DISPlay.SP(1-1).Y.SCALe.DIVisions
Copies trace data to the user trace	SCPI.CALCulate.SP(1-1).TRACe(1-1).DATA.COPY	
Spectrum monitor - File operation	Saves trace data	SCPI.MMEMory.SP(1-1).TRACe(1-1).STORe.DATA
	Saves memory trace data	SCPI.MMEMory.SP(1-1).TRACe(1-1).STORe.MEMory
Spectrum monitor - Harmonics	Sets/reads the carrier frequency band	SCPI.SENSE.SP(1-1).CARRier.FBANd
	Changes the center frequency to N times the carrier frequency	SCPI.SENSE.SP(1-1).CARRier.SET.CENTer

COM Object Reference  
List by function

Function	Setting/Execution item	COM object
Spectrum monitor - Limit Test	Reads out the limit test result	SCPI.CALCulate.SP(1-1).ALLTrace.LIMit.FAIL
	Turns on/off the limit test function	SCPI.CALCulate.SP(1-1).TRACe(1-1).LIMit.STATe
	Sets/reads the number of segments in the upper limit line	SCPI.CALCulate.SP(1-1).TRACe(1-1).LIMit.UPPer.SEGMent.COUNt
	Sets/reads the number of segments in the lower limit line	SCPI.CALCulate.SP(1-1).TRACe(1-1).LIMit.LOWer.SEGMent.COUNt
	Sets/reads segment data of the upper limit line	SCPI.CALCulate.SP(1-1).TRACe(1-1).LIMit.UPPer.SEGMent.DATA
	Sets/reads segment data of the lower limit line	SCPI.CALCulate.SP(1-1).TRACe(1-1).LIMit.LOWer.SEGMent.DATA
	Clears the upper limit line	SCPI.CALCulate.SP(1-1).TRACe(1-1).LIMit.UPPer.SEGMent.CLEAr
	Clears the lower limit line	SCPI.CALCulate.SP(1-1).TRACe(1-1).LIMit.LOWer.SEGMent.CLEAr
	Sets/reads the upper limit values of all measurement points	SCPI.CALCulate.SP(1-1).TRACe(1-1).LIMit.UPPer.LDATA
	Sets/reads the lower limit values of all measurement points	SCPI.CALCulate.SP(1-1).TRACe(1-1).LIMit.LOWer.LDATA
	Reads out the limit test result	SCPI.CALCulate.SP(1-1).TRACe(1-1).LIMit.FAIL
	Reads the limit test results of all measurement points in selected traces	SCPI.CALCulate.SP(1-1).TRACe(1-1).LIMit.REPort.DATA
	Turns on/off the limit line	SCPI.DISPlay.SP(1-1).TRACe(1-1).LIMit.LINE
	Turns on/off the limit test judgement display	SCPI.DISPlay.SP(1-1).LIMit.FSIGN
	Reads the upper limit line	SCPI.MMEMory.SP(1-1).TRACe(1-1).LOAD.LIMit.UPPer
Reads the lower limit line	SCPI.MMEMory.SP(1-1).TRACe(1-1).LOAD.LIMit.LOWer	
Spectrum monitor - Marker/Analysis	Turns on/off marker coupling function	SCPI.CALCulate.SP(1-1).ALLTrace.MARKer.COUPle.STATe
	Sets/reads marker movement (Continuous/Discrete)	SCPI.CALCulate.SP(1-1).ALLTrace.MARKer.DISCrete.STATe
	Sets/reads marker reference number	SCPI.CALCulate.SP(1-1).ALLTrace.MARKer.REFerence.NUMBer
	Turns on/off delta marker mode	SCPI.CALCulate.SP(1-1).ALLTrace.MARKer.REFerence.STATe
	Selects active marker	SCPI.CALCulate.SP(1-1).TRACe(1-1).ALLMarker.ACTive
	Sets/reads marker search range (X-axis)	SCPI.CALCulate.SP(1-1).TRACe(1-1).ALLMarker.SEA Rch.DOMain.X
	Sets/reads marker search range (Y-axis)	SCPI.CALCulate.SP(1-1).TRACe(1-1).ALLMarker.SEA Rch.DOMain.Y

Function	Setting/Execution item	COM object
Spectrum monitor - Marker/Analysis (Continued)	Execute marker search all	SCPI.CALCulate.SP(1-1).TRACe(1-1).ALLMarker.SEA Rch.PEAK
	Sets/reads the center value of bandmarker X	SCPI.CALCulate.SP(1-1).TRACe(1-1).BDMarker.X.CE NTer
	Sets/reads the span value of bandmarker X	SCPI.CALCulate.SP(1-1).TRACe(1-1).BDMarker.X.SPA N
	Sets/reads the start value of bandmarker X	SCPI.CALCulate.SP(1-1).TRACe(1-1).BDMarker.X.STA Rt
	Turns on/off bandmarker X	SCPI.CALCulate.SP(1-1).TRACe(1-1).BDMarker.X.STA Te
	Sets/reads the stop value of bandmarker X	SCPI.CALCulate.SP(1-1).TRACe(1-1).BDMarker.X.ST OP
	Sets/reads the center value of bandmarker Y	SCPI.CALCulate.SP(1-1).TRACe(1-1).BDMarker.Y.CE NTer
	Sets/reads the span value of bandmarker Y	SCPI.CALCulate.SP(1-1).TRACe(1-1).BDMarker.Y.SPA N
	Sets/reads the start value of bandmarker Y	SCPI.CALCulate.SP(1-1).TRACe(1-1).BDMarker.Y.STA Rt
	Turns on/off bandmarker Y	SCPI.CALCulate.SP(1-1).TRACe(1-1).BDMarker.Y.STA Te
	Sets/reads the stop value of bandmarker Y	SCPI.CALCulate.SP(1-1).TRACe(1-1).BDMarker.Y.STO P
	Sets/reads analysis/search range (X-axis)	SCPI.CALCulate.SP(1-1).TRACe(1-1).FUNCtion.DOMa in.X
	Sets/reads analysis/search range (Y-axis)	SCPI.CALCulate.SP(1-1).TRACe(1-1).FUNCtion.DOMa in.Y
	Reads the results of statistical analysis for the data trace	SCPI.CALCulate.SP(1-1).TRACe(1-1).FUNCtion.STATI stics.DATA_Q mean, std_dev, peak_to_peak
	Reads the results of statistical analysis for the memory trace	SCPI.CALCulate.SP(1-1).TRACe(1-1).FUNCtion.STATI stics.MEMory_Q mean, std_dev, peak_to_peak
	Sets/reads analysis type	SCPI.CALCulate.SP(1-1).TRACe(1-1).FUNCtion.TYPE
	Execute marker peak search left	SCPI.CALCulate.SP(1-1).TRACe(1-1).MARKer(1-6).SE ARch.EXECute.LPEak
	Execute marker target search left	SCPI.CALCulate.SP(1-1).TRACe(1-1).MARKer(1-6).SE ARch.EXECute.LTARget
	Execute marker search maximum	SCPI.CALCulate.SP(1-1).TRACe(1-1).MARKer(1-6).SE ARch.EXECute.MAXimum
	Execute marker search minimum	SCPI.CALCulate.SP(1-1).TRACe(1-1).MARKer(1-6).SE ARch.EXECute.MINimum
	execute marker peak search	SCPI.CALCulate.SP(1-1).TRACe(1-1).MARKer(1-6).SE ARch.EXECute.PEAK
	Execute marker peak search right	SCPI.CALCulate.SP(1-1).TRACe(1-1).MARKer(1-6).SE ARch.EXECute.RPEak

COM Object Reference  
List by function

Function	Setting/Execution item	COM object
Spectrum monitor - Marker/Analysis (Continued)	Execute marker target search right	SCPI.CALCulate.SP(1-1).TRACe(1-1).MARKer(1-6).SEARch.EXECute.RTARget
	Execute marker target search	SCPI.CALCulate.SP(1-1).TRACe(1-1).MARKer(1-6).SEARch.EXECute.TARGet
	Sets/reads the peak excursion value	SCPI.CALCulate.SP(1-1).TRACe(1-1).MARKer(1-6).SEARch.PEAK.EXCursion
	Sets/reads the marker peak-search polarity	SCPI.CALCulate.SP(1-1).TRACe(1-1).MARKer(1-6).SEARch.PEAK.POLarity
	Sets/reads the target transition definition	SCPI.CALCulate.SP(1-1).TRACe(1-1).MARKer(1-6).SEARch.TARGet.TRANsition
	Sets/reads the marker target value	SCPI.CALCulate.SP(1-1).TRACe(1-1).MARKer(1-6).SEARch.TARGet.Y
	Sets/reads the marker tracking type	SCPI.CALCulate.SP(1-1).TRACe(1-1).MARKer(1-6).SEARch.TRACking.TYPE
	Turns on/off markers	SCPI.CALCulate.SP(1-1).TRACe(1-1).MARKer(1-6).STATe
	Sets/reads the marker X value	SCPI.CALCulate.SP(1-1).TRACe(1-1).MARKer(1-6).X
	Reads the marker Y value	SCPI.CALCulate.SP(1-1).TRACe(1-1).MARKer(1-6).Y
	Sets/reads the marker information position	SCPI.DISPlay.SP(1-1).ANNotation.MARKer.POSition
	Turns on/off the marker list	SCPI.DISPlay.SP(1-1).TABLe.STATe
	Spectrum monitor - Measurement	always move to waiting-for-trigger state after measuring
move once to waiting-for-trigger state		SCPI.INITiate.SP(1-1).IMMEdiate
trigger source		SCPI.TRIGger.SP(1-1).SOURce
Spectrum monitor - Measurement conditions	Restart averaging	SCPI.SENSE.SP(1-1).AVERAge.CLEAr
	Sets/reads the averaging count	SCPI.SENSE.SP(1-1).AVERAge.COUNt
	Turns on/off averaging function	SCPI.SENSE.SP(1-1).AVERAge.STATe
	Sets/reads averaging type	SCPI.SENSE.SP(1-1).AVERAge.TYPE
	Sets/reads RBW value	SCPI.SENSE.SP(1-1).BANDwidth.RESolution
	Sets/reads detector mode	SCPI.SENSE.SP(1-1).DETEctor.FUNCTion
	Sets/reads the center value of frequency span	SCPI.SENSE.SP(1-1).FREQUency.CENTer
	Sets/reads the span value of frequency span	SCPI.SENSE.SP(1-1).FREQUency.SPAN
	Sets/reads the start value of frequency span	SCPI.SENSE.SP(1-1).FREQUency.STARt
	Sets/reads the stop value of frequency span	SCPI.SENSE.SP(1-1).FREQUency.STOP
	Sets/reads the reference level of frequency span	SCPI.SENSE.SP(1-1).POWEr.RLEVeL
Spectrum monitor - Reads/writes the data	Sets/reads the raw data	SCPI.CALCulate.SP(1-1).DATA.RDATA
	Reads X-axis data	SCPI.CALCulate.SP(1-1).DATA.XDATA
	Sets/reads formatted trace data	SCPI.CALCulate.SP(1-1).TRACe(1-1).DATA.FDATA



Function	Setting/Execution item	COM object
Spectrum monitor - Reads/writes the data (Continued)	Sets/reads formatted memory data	SCPI.CALCulate.SP(1-1).TRACe(1-1).DATA.FMEMory
	Sets/reads unformatted trace data	SCPI.CALCulate.SP(1-1).TRACe(1-1).DATA.UDATA
	Sets/reads unformatted memory data	SCPI.CALCulate.SP(1-1).TRACe(1-1).DATA.UMEMory
	Reads the number of measurement points	SCPI.SENSE.SP(1-1).SWEep.POINts
Status report system	Clears registers	SCPI.IEEE4882.CLS
	Sets/reads standard event status enable register	SCPI.IEEE4882.ESE
	Reads standard event status register value	SCPI.IEEE4882.ESR
	Sets OPC bit on operation termination	SCPI.IEEE4882.OPC
	Sets service request enable register	SCPI.IEEE4882.SRE
	Reads status byte register	SCPI.IEEE4882.STB
	Clears operation-program status condition register	SCPI.STATus.OPERation.BIT12.CLEar
	Reads operation-program status register	SCPI.STATus.OPERation.BIT12.CONDITION
	Sets/reads operation-program status enable register	SCPI.STATus.OPERation.BIT12.ENABLE
	Reads operation-program status event register	SCPI.STATus.OPERation.BIT12.EVENT
	Sets/reads operation-program status negative transition filter value	SCPI.STATus.OPERation.BIT12.NTRansition
	Sets/reads operation-program status positive transition filter value	SCPI.STATus.OPERation.BIT12.PTRansition
	Sets operation-program status condition register	SCPI.STATus.OPERation.BIT12.SET
	Reads operation status conditional register value	SCPI.STATus.OPERation.CONDITION
	Set/reads operation status enable register	SCPI.STATus.OPERation.ENABLE
	Reads operation status event register	SCPI.STATus.OPERation.EVENT
	Sets/reads operation status negative transition filter value	SCPI.STATus.OPERation.NTRansition
	Sets/reads operation status positive transition filter value	SCPI.STATus.OPERation.PTRansition
	Reset status registers	SCPI.STATus.PRESet
	Reads questionable status conditional register value	SCPI.STATus.QUEStionable.CONDITION
	Sets/reads questionable-current status enable register	SCPI.STATus.QUEStionable.CURRent.ENABLE
	Reads questionable-current status event register value	SCPI.STATus.QUEStionable.CURRent.EVENT
	Sets/reads questionable status enable register	SCPI.STATus.QUEStionable.ENABLE
	Reads questionable status event register value	SCPI.STATus.QUEStionable.EVENT
	Sets/reads questionable-misc status enable register	SCPI.STATus.QUEStionable.MISC.ENABLE
	Reads questionable-misc status event register value	SCPI.STATus.QUEStionable.MISC.EVENT
	Sets/reads questionable status negative transition filter value	SCPI.STATus.QUEStionable.NTRansition

COM Object Reference  
List by function

Function	Setting/Execution item	COM object
Status report system (Continued)	Sets/reads questionable-phase status enable register	SCPI.STATus.QUEStionable.PHASE.ENABLE
	Reads questionable-phase status event register	SCPI.STATus.QUEStionable.PHASE.EVENT
	Sets/reads questionable-power status enable register	SCPI.STATus.QUEStionable.POWer.ENABLE
	Reads questionable-power status event register value	SCPI.STATus.QUEStionable.POWer.EVENT
	Sets/reads questionable status positive transition filter value	SCPI.STATus.QUEStionable.PTRansition
	Sets/reads questionable-reference signal status enable register	SCPI.STATus.QUEStionable.REFerence.ENABLE
	Reads questionable-reference signal status event register value	SCPI.STATus.QUEStionable.REFerence.EVENT
	Reads the questionable limit conditional register value	SCPI.STATus.QUEStionable.LIMit.CONDITION
	Sets/reads the questionable limit status enable value	SCPI.STATus.QUEStionable.LIMit.ENABLE
	Reads the questionable limit status event register value	SCPI.STATus.QUEStionable.LIMit.EVENT
	Sets/reads the questionable limit status positive transition filter value	SCPI.STATus.QUEStionable.LIMit.PTRansition
	Sets/reads the questionable limit status negative transition filter value	SCPI.STATus.QUEStionable.LIMit.NTRansition
	Reads the questionable limit conditional register value (FP)	SCPI.STATus.QUEStionable.LIMit.FP(1-1).CONDITION
	Sets/reads the questionable limit status enable value (FP)	SCPI.STATus.QUEStionable.LIMit.FP(1-1).ENABLE
	Reads the questionable limit status event register value (FP)	SCPI.STATus.QUEStionable.LIMit.FP(1-1).EVENT
	Sets/reads the questionable limit status positive transition filter value (FP)	SCPI.STATus.QUEStionable.LIMit.FP(1-1).PTRansition
	Sets/reads the questionable limit status negative transition filter value (FP)	SCPI.STATus.QUEStionable.LIMit.FP(1-1).NTRansition
	Reads the questionable limit conditional register value (PN)	SCPI.STATus.QUEStionable.LIMit.PN(1-1).CONDITION
	Sets/reads the questionable limit status enable value (PN)	SCPI.STATus.QUEStionable.LIMit.PN(1-1).ENABLE
	Reads the questionable limit status event register value (PN)	SCPI.STATus.QUEStionable.LIMit.PN(1-1).EVENT
	Sets/reads the questionable limit status positive transition filter value (PN)	SCPI.STATus.QUEStionable.LIMit.PN(1-1).PTRansition
	Sets/reads the questionable limit status negative transition filter value (PN)	SCPI.STATus.QUEStionable.LIMit.PN(1-1).NTRansition
	Reads the questionable limit conditional register value (SP)	SCPI.STATus.QUEStionable.LIMit.SP(1-1).CONDITION

Function	Setting/Execution item	COM object
Status report system (Continued)	Sets/reads the questionable limit status enable value (SP)	SCPI.STATus.QUEStionable.LIMit.SP(1-1).ENABle
	Reads the questionable limit status event register value (SP)	SCPI.STATus.QUEStionable.LIMit.SP(1-1).EVENT
	Sets/reads the questionable limit status positive transition filter value (SP)	SCPI.STATus.QUEStionable.LIMit.SP(1-1).PTRansition
	Sets/reads the questionable limit status negative transition filter value (SP)	SCPI.STATus.QUEStionable.LIMit.SP(1-1).NTRansition
	Reads the questionable limit conditional register value (TR)	SCPI.STATus.QUEStionable.LIMit.TR(1-1).CONDition
	Sets/reads the questionable limit status enable value (TR)	SCPI.STATus.QUEStionable.LIMit.TR(1-1).ENABle
	Reads the questionable limit status event register value (TR)	SCPI.STATus.QUEStionable.LIMit.TR(1-1).EVENT
	Sets/reads the questionable limit status positive transition filter value (TR)	SCPI.STATus.QUEStionable.LIMit.TR(1-1).PTRansition
	Sets/reads the questionable limit status negative transition filter value (TR)	SCPI.STATus.QUEStionable.LIMit.TR(1-1).NTRansition
	Reads the questionable limit conditional register value (USER)	SCPI.STATus.QUEStionable.LIMit.USER(1-1).CONDition
	Sets/reads the questionable limit status enable value (USER)	SCPI.STATus.QUEStionable.LIMit.USER(1-1).ENABle
	Reads the questionable limit status event register value (USER)	SCPI.STATus.QUEStionable.LIMit.USER(1-1).EVENT
	Sets/reads the questionable limit status positive transition filter value (USER)	SCPI.STATus.QUEStionable.LIMit.USER(1-1).PTRansition
	Sets/reads the questionable limit status negative transition filter value (USER)	SCPI.STATus.QUEStionable.LIMit.USER(1-1).NTRansition
	Transient measurement - Display	Selects active trace
Selects phase format on transient measurement		SCPI.CALCulate.TR(1-1).TRACe(1-4).FORMat.PHASE.UNIT
Turns on/off wrap-phase		SCPI.CALCulate.TR(1-1).TRACe(1-4).FORMat.PHASE.WRAP
Sets/reads data hold		SCPI.CALCulate.TR(1-1).TRACe(1-4).HOLD
Selects math operation type		SCPI.CALCulate.TR(1-1).TRACe(1-4).MATH.FUNCTioN
Copy data to memory		SCPI.CALCulate.TR(1-1).TRACe(1-4).MATH.MEMorize
Smoothing aperture		SCPI.CALCulate.TR(1-1).TRACe(1-4).SMOothing.APErture
Smoothing on/off		SCPI.CALCulate.TR(1-1).TRACe(1-4).SMOothing.STATe
clear all stored traces		SCPI.DISPlay.TR(1-1).ALLTrace.PERSistence.CLEar

COM Object Reference  
List by function

Function	Setting/Execution item	COM object
Transient measurement - Display (Continued)	auto scale all	SCPI.DISPlay.TR(1-1).ALLTrace.Y.SCALe.AUTO
	Turns on/off measurement conditions	SCPI.DISPlay.TR(1-1).ANNOtation.MEASurement.STATe
	Sets/reads relative Y-scale	SCPI.DISPlay.TR(1-1).GRATicule.AXIS.Y.RELAtive
	Sets/reads the number of Y-digits	SCPI.DISPlay.TR(1-1).GRATicule.AXIS.Y.STATe
	Edits window title label	SCPI.DISPlay.TR(1-1).LABel.DATA
	Turns on/off window title lable	SCPI.DISPlay.TR(1-1).LABel.STATe
	maximize active trace	SCPI.DISPlay.TR(1-1).MAXimize
	Turns on/off transient measurement mode	SCPI.DISPlay.TR(1-1).STATe
	Trace Title Label	SCPI.DISPlay.TR(1-1).TRACe(1-4).LABel.DATA
	show data and/or memory trace	SCPI.DISPlay.TR(1-1).TRACe(1-4).MODE
	Clears persistent data	SCPI.DISPlay.TR(1-1).TRACe(1-4).PERSistence.CLEAr
	Sets/reads persistence mode	SCPI.DISPlay.TR(1-1).TRACe(1-4).PERSistence.STATe
	Execute autoscale	SCPI.DISPlay.TR(1-1).TRACe(1-4).Y.SCALe.AUTO
	scale per division	SCPI.DISPlay.TR(1-1).TRACe(1-4).Y.SCALe.PDIVision
	scale reference level	SCPI.DISPlay.TR(1-1).TRACe(1-4).Y.SCALe.RLEVel
	scale reference position	SCPI.DISPlay.TR(1-1).TRACe(1-4).Y.SCALe.RPOSITION
	Sets/reads # of Y division	SCPI.DISPlay.TR(1-1).Y.SCALe.DIVisions
	Copies trace data to the user trace	SCPI.CALCulate.TR(1-1).TRACe(1-4).DATA.COPY
	Sets/reads the frequency format	SCPI.CALCulate.TR(1-1).TRACe(1-4).FORMat.FREQuency
	Sets/reads the reference frequency	SCPI.CALCulate.TR(1-1).TRACe(1-4).REFerence.FREQuency
Reads the trace parmeter.	SCPI.CALCulate.TR(1-1).TRACe(1-4).PARAmeter	
Transient measurement - File operation	Saves trace data	SCPI.MMEMory.TR(1-1).TRACe(1-4).STORE.DATA
	Saves memory trace data	SCPI.MMEMory.TR(1-1).TRACe(1-4).STORE.MEMory
Transient measurement - Limit Test	Reads out the limit test result	SCPI.CALCulate.TR(1-1).ALLTrace.LIMit.FAIL
	Turns on/off the limit test function	SCPI.CALCulate.TR(1-1).TRACe(1-4).LIMit.STATe
	Sets/reads the number of segments in the upper limit line	SCPI.CALCulate.TR(1-1).TRACe(1-4).LIMit.UPPer.SEGMent.COUNT
	Sets/reads the number of segments in the lower limit line	SCPI.CALCulate.TR(1-1).TRACe(1-4).LIMit.LOWer.SEGMent.COUNT
	Sets/reads segment data of the upper limit line	SCPI.CALCulate.TR(1-1).TRACe(1-4).LIMit.UPPer.SEGMent.DATA
	Sets/reads segment data of the lower limit line	SCPI.CALCulate.TR(1-1).TRACe(1-4).LIMit.LOWer.SEGMent.DATA

Function	Setting/Execution item	COM object
Transient measurement - Limit Test (Continued)	Clears the upper limit line	SCPI.CALCulate.TR(1-1).TRACe(1-4).LIMit.UPPer.SEGMent.CLEar
	Clears the lower limit line	SCPI.CALCulate.TR(1-1).TRACe(1-4).LIMit.LOWer.SEGMent.CLEar
	Sets/reads the upper limit values of all measurement points	SCPI.CALCulate.TR(1-1).TRACe(1-4).LIMit.UPPer.LDAta
	Sets/reads the lower limit values of all measurement points	SCPI.CALCulate.TR(1-1).TRACe(1-4).LIMit.LOWer.LDAta
	Reads out the limit test result	SCPI.CALCulate.TR(1-1).TRACe(1-4).LIMit.FAIL
	Reads the limit test results of all measurement points in selected traces	SCPI.CALCulate.TR(1-1).TRACe(1-4).LIMit.REPort.DAta
	Turns on/off the limit line	SCPI.DISPlay.TR(1-1).TRACe(1-4).LIMit.LINE
	Turns on/off the limit test judgement display	SCPI.DISPlay.TR(1-1).LIMit.FSIGN
	Reads the upper limit line	SCPI.MMEMory.TR(1-1).TRACe(1-4).LOAD.LIMit.UPPer
	Reads the lower limit line	SCPI.MMEMory.TR(1-1).TRACe(1-4).LOAD.LIMit.LOWer
Transient measurement - Marker/analysis	Turns on/off bandmarker coupling function	SCPI.CALCulate.TR(1-1).ALLTrace.BDMarker.X.COUPle.STATe
	Turns on/off marker coupling function	SCPI.CALCulate.TR(1-1).ALLTrace.MARKer.COUPle.STATe
	Sets/reads marker movement (Continuous/Discrete)	SCPI.CALCulate.TR(1-1).ALLTrace.MARKer.DISCrete.STATe
	Sets/reads marker reference number	SCPI.CALCulate.TR(1-1).ALLTrace.MARKer.REFerence.NUMBer
	Turns on/off delta marker mode	SCPI.CALCulate.TR(1-1).ALLTrace.MARKer.REFerence.STATe
	Selects active marker	SCPI.CALCulate.TR(1-1).TRACe(1-4).ALLMarker.ACTive
	Sets/reads marker search range (X-axis)	SCPI.CALCulate.TR(1-1).TRACe(1-4).ALLMarker.SEA Rch.DOMain.X
	Sets/reads marker search range (Y-axis)	SCPI.CALCulate.TR(1-1).TRACe(1-4).ALLMarker.SEA Rch.DOMain.Y
	Execute marker search all	SCPI.CALCulate.TR(1-1).TRACe(1-4).ALLMarker.SEA Rch.PEAK
	Sets/reads the center value of bandmarker X	SCPI.CALCulate.TR(1-1).TRACe(1-4).BDMarker.X.CENTer
	Sets/reads the span value of bandmarker X	SCPI.CALCulate.TR(1-1).TRACe(1-4).BDMarker.X.SPAN
	Sets/reads the start value of bandmarker X	SCPI.CALCulate.TR(1-1).TRACe(1-4).BDMarker.X.STARt
	Turn on/off bandmarker X	SCPI.CALCulate.TR(1-1).TRACe(1-4).BDMarker.X.STATe

COM Object Reference  
List by function

Function	Setting/Execution item	COM object
Transient measurement - Marker/analysis (Continued)	Sets/reads the stop value of bandmarker X	SCPI.CALCulate.TR(1-1).TRACe(1-4).BDMarker.X.STOP
	Sets/reads the center value of bandmarker Y	SCPI.CALCulate.TR(1-1).TRACe(1-4).BDMarker.Y.CENTer
	Sets/reads the span value of bandmarker Y	SCPI.CALCulate.TR(1-1).TRACe(1-4).BDMarker.Y.SPAN
	Sets/reads the start value of bandmarker Y	SCPI.CALCulate.TR(1-1).TRACe(1-4).BDMarker.Y.STARt
	Turn on/off bandmarker Y	SCPI.CALCulate.TR(1-1).TRACe(1-4).BDMarker.Y.STATe
	Sets/reads the stop value of bandmarker Y	SCPI.CALCulate.TR(1-1).TRACe(1-4).BDMarker.Y.STOP
	Sets/reads analysis/search range (X-axis)	SCPI.CALCulate.TR(1-1).TRACe(1-4).FUNction.DOMain.X
	Sets/reads analysis/search range (Y-axis)	SCPI.CALCulate.TR(1-1).TRACe(1-4).FUNction.DOMain.Y
	Reads the result of statistical analysis for the data trace	SCPI.CALCulate.TR(1-1).TRACe(1-4).FUNction.STATistics.DATA_Q mean, std_dev, peak_to_peak
	Reads the result of statistical analysis for the memory trace	SCPI.CALCulate.TR(1-1).TRACe(1-4).FUNction.STATistics.MEMory_Q mean, std_dev, peak_to_peak
	Sets/reads analysis type	SCPI.CALCulate.TR(1-1).TRACe(1-4).FUNction.TYPE
	Execute marker peak search left	SCPI.CALCulate.TR(1-1).TRACe(1-4).MARKer(1-6).SEARch.EXECute.LPEak
	Execute marker target search left	SCPI.CALCulate.TR(1-1).TRACe(1-4).MARKer(1-6).SEARch.EXECute.LTARget
	Execute marker search maximum	SCPI.CALCulate.TR(1-1).TRACe(1-4).MARKer(1-6).SEARch.EXECute.MAXimum
	Execute marker search minimum	SCPI.CALCulate.TR(1-1).TRACe(1-4).MARKer(1-6).SEARch.EXECute.MINimum
	Execute marker peak search	SCPI.CALCulate.TR(1-1).TRACe(1-4).MARKer(1-6).SEARch.EXECute.PEAK
	Execute marker peak search right	SCPI.CALCulate.TR(1-1).TRACe(1-4).MARKer(1-6).SEARch.EXECute.RPEak
	Execute marker target search right	SCPI.CALCulate.TR(1-1).TRACe(1-4).MARKer(1-6).SEARch.EXECute.RTARget
	Execute marker target search	SCPI.CALCulate.TR(1-1).TRACe(1-4).MARKer(1-6).SEARch.EXECute.TARGet
	Sets/reads the peak excursion value	SCPI.CALCulate.TR(1-1).TRACe(1-4).MARKer(1-6).SEARch.PEAK.EXCursion
	Sets/reads the marker peak-search polarity	SCPI.CALCulate.TR(1-1).TRACe(1-4).MARKer(1-6).SEARch.PEAK.POLarity
Sets/reads the target transition definition	SCPI.CALCulate.TR(1-1).TRACe(1-4).MARKer(1-6).SEARch.TARGet.TRANSition	

Function	Setting/Execution item	COM object
Transient measurement - Marker/analysis (Continued)	Sets/reads the marker target value	SCPI.CALCulate.TR(1-1).TRACe(1-4).MARKer(1-6).SEARCh.TARGET.Y
	Sets/reads the marker tracking type	SCPI.CALCulate.TR(1-1).TRACe(1-4).MARKer(1-6).SEARCh.TRACKing.TYPE
	Turns on/off markers	SCPI.CALCulate.TR(1-1).TRACe(1-4).MARKer(1-6).STATe
	Sets/reads the marker X value	SCPI.CALCulate.TR(1-1).TRACe(1-4).MARKer(1-6).X
	Reads the marker Y value	SCPI.CALCulate.TR(1-1).TRACe(1-4).MARKer(1-6).Y
	Sets/reads the marker information position	SCPI.DISPlay.TR(1-1).ANNOtation.MARKer.POSition
	Turns on/off the marker list	SCPI.DISPlay.TR(1-1).TABLe.STATe
Transient measurement - Measurement	always move to waiting-for-trigger state after measuring	SCPI.INITiate.TR(1-1).CONTinuous
	move once to waiting-for-trigger state	SCPI.INITiate.TR(1-1).IMMEDIATE
Transient measurement - Measurement conditions	average clear	SCPI.SENSE.TR(1-1).AVERage.CLEAr
	average count	SCPI.SENSE.TR(1-1).AVERage.COUNt
	average ON/OFF	SCPI.SENSE.TR(1-1).AVERage.STATe
	phase reference frequency	SCPI.SENSE.TR(1-1).NARRow.FREQUency.PREFErEncE
	frequency span	SCPI.SENSE.TR(1-1).NARRow.FREQUency.RANGe
	target frequency	SCPI.SENSE.TR(1-1).NARRow.FREQUency.TARGET
	offset for reference point	SCPI.SENSE.TR(1-1).NARRow.TIME.OFFSet
	reference position for span	SCPI.SENSE.TR(1-1).NARRow.TIME.REFerence
	time span	SCPI.SENSE.TR(1-1).NARRow.TIME.SPAN
	Max Input Level	SCPI.SENSE.TR(1-1).POWEr.INPut.LEVel.MAXimum
	Set/get transient frequency range in the wideband mode	SCPI.SENSE.TR(1-1).WIDE.FREQUency.MAXimum
	offset for reference point	SCPI.SENSE.TR(1-1).WIDE.TIME.OFFSet
	reference position for span	SCPI.SENSE.TR(1-1).WIDE.TIME.REFerence
	time span	SCPI.SENSE.TR(1-1).WIDE.TIME.SPAN
	narrow video trigger frequency	SCPI.TRIGger.TR(1-1).NARRow.VIDeo.FREQUency.CENTer
	video trigger threshold level relative to max input level	SCPI.TRIGger.TR(1-1).NARRow.VIDeo.THREShold
	trigger source	SCPI.TRIGger.TR(1-1).SOURce
	wide video trigger frequency	SCPI.TRIGger.TR(1-1).WIDE.VIDeo.FREQUency.CENTer
	Sets/reads the offset value of the phase reference frequency	SCPI.CALCulate.TR(1-1).TRACe(1-4).FORMat.PHASE.PREFErence.OFFSet

COM Object Reference  
List by function

Function	Setting/Execution item	COM object
Transient measurement - Reads/writes the data	measurement raw data	SCPI.CALCulate.TR(1-1).NARRow.DATA.RDATA
	X axis data	SCPI.CALCulate.TR(1-1).NARRow.DATA.XDATA
	Sets/reads formatted trace data	SCPI.CALCulate.TR(1-1).TRACe(1-4).DATA.FDATA
	Sets/reads formatted memory data	SCPI.CALCulate.TR(1-1).TRACe(1-4).DATA.FMEMory
	Sets/reads unformatted trace data	SCPI.CALCulate.TR(1-1).TRACe(1-4).DATA.UDATA
	Sets/reads unformatted memory data	SCPI.CALCulate.TR(1-1).TRACe(1-4).DATA.UMEMory
	measurement raw data	SCPI.CALCulate.TR(1-1).WIDE.DATA.RDATA
	X axis data	SCPI.CALCulate.TR(1-1).WIDE.DATA.XDATA
	# of points	SCPI.SENSE.TR(1-1).NARRow.SWEep.POINts
	# of points	SCPI.SENSE.TR(1-1).WIDE.SWEep.POINts
User defined window - Display	Selects active trace	SCPI.CALCulate.USER(1-1).ALLTrace.ACTive
	Selects math operation type	SCPI.CALCulate.USER(1-1).TRACe(1-8).MATH.FUNCtion
	Copy data to memory	SCPI.CALCulate.USER(1-1).TRACe(1-8).MATH.MEMorize
	Smoothing aperture	SCPI.CALCulate.USER(1-1).TRACe(1-8).SMOothing.APERTure
	Smoothing on/off	SCPI.CALCulate.USER(1-1).TRACe(1-8).SMOothing.STATE
	clear all stored traces	SCPI.DISPlay.USER(1-1).ALLTrace.PERSistence.CLEAr
	auto scale all	SCPI.DISPlay.USER(1-1).ALLTrace.Y.SCALE.AUTO
	Turns on/off measurement conditions	SCPI.DISPlay.USER(1-1).ANNotation.MEASurement.STATE
	ossible.	SCPI.DISPlay.USER(1-1).GRATICule.AXIS.Y.RELative
	Show/Hide Y graticule label	SCPI.DISPlay.USER(1-1).GRATICule.AXIS.Y.STATE
	Window Title Label	SCPI.DISPlay.USER(1-1).LABel.DATA
	Show/Hide Window Title Label	SCPI.DISPlay.USER(1-1).LABel.STATE
	maximize active trace	SCPI.DISPlay.USER(1-1).MAXimize
	Turns on/off user defined window	SCPI.DISPlay.USER(1-1).STATE
	Trace Title Label	SCPI.DISPlay.USER(1-1).TRACe(1-8).LABel.DATA
	show data and/or memory trace	SCPI.DISPlay.USER(1-1).TRACe(1-8).MODE
	Clears persistent data	SCPI.DISPlay.USER(1-1).TRACe(1-8).PERSistence.STATE
	Sets/reads persistence mode	SCPI.DISPlay.USER(1-1).TRACe(1-8).STATE
	X axis unit	SCPI.DISPlay.USER(1-1).TRACe(1-8).X.UNIT
	Execute autoscale	SCPI.DISPlay.USER(1-1).TRACe(1-8).Y.SCALE.AUTO



Function	Setting/Execution item	COM object
User defined window - Display (Continued)	scale per division	SCPI.DISPlay.USER(1-1).TRACe(1-8).Y.SCALe.PDIVis ion
	scale reference level	SCPI.DISPlay.USER(1-1).TRACe(1-8).Y.SCALe.RLEVe l
	scale reference position	SCPI.DISPlay.USER(1-1).TRACe(1-8).Y.SCALe.RPOSit ion
	Y axis unit	SCPI.DISPlay.USER(1-1).TRACe(1-8).Y.UNIT
	Sets/reads # of Y division	SCPI.DISPlay.USER(1-1).Y.SCALe.DIVisions
	Sets/reads the display type of the x axis.	SCPI.DISPlay.USER(1-1).TRACe(1-8).X.TYPE
	Copies trace data to the user trace	SCPI.CALCulate.USER(1-1).TRACe(1-8).DATA.COPY
User defined window - File operation	Saves selected trace data	SCPI.MMEMory.USER(1-1).TRACe(1-8).STORE.DATA
	Saves selected memory trace data	SCPI.MMEMory.USER(1-1).TRACe(1-8).STORE.MEM ory
User defined window - Limit Test	Reads out the limit test result	SCPI.CALCulate.USER(1-1).ALLTrace.LIMit.FAIL
	Turns on/off the limit test function	SCPI.CALCulate.USER(1-1).TRACe(1-8).LIMit.STATe
	Sets/reads the number of segments in the upper limit line	SCPI.CALCulate.USER(1-1).TRACe(1-8).LIMit.UPPer. SEGMENT.COUNt
	Sets/reads the number of segments in the lower limit line	SCPI.CALCulate.USER(1-1).TRACe(1-8).LIMit.LOWer .SEGMENT.COUNt
	Sets/reads segment data of the upper limit line	SCPI.CALCulate.USER(1-1).TRACe(1-8).LIMit.UPPer. SEGMENT.DATA
	Sets/reads segment data of the lower limit line	SCPI.CALCulate.USER(1-1).TRACe(1-8).LIMit.LOWer .SEGMENT.DATA
	Clears the upper limit line	SCPI.CALCulate.USER(1-1).TRACe(1-8).LIMit.UPPer. SEGMENT.CLEAr
	Clears the lower limit line	SCPI.CALCulate.USER(1-1).TRACe(1-8).LIMit.LOWer .SEGMENT.CLEAr
	Sets/reads the upper limit values of all measurement points	SCPI.CALCulate.USER(1-1).TRACe(1-8).LIMit.UPPer. LDAta
	Sets/reads the lower limit values of all measurement points	SCPI.CALCulate.USER(1-1).TRACe(1-8).LIMit.LOWer .LDAta
	Reads out the limit test result	SCPI.CALCulate.USER(1-1).TRACe(1-8).LIMit.FAIL
	Reads the limit test results of all measurement points in selected traces	SCPI.CALCulate.USER(1-1).TRACe(1-8).LIMit.REPort. DATA
	Turns on/off the limit line	SCPI.DISPlay.USER(1-1).TRACe(1-8).LIMit.LINE
	Turns on/off the limit test judgement display	SCPI.DISPlay.USER(1-1).LIMit.FSIGN
	Reads the upper limit line	SCPI.MMEMory.USER(1-1).TRACe(1-8).LOAD.LIMit. UPPer
	Reads the lower limit line	SCPI.MMEMory.USER(1-1).TRACe(1-8).LOAD.LIMit. LOWer

COM Object Reference  
List by function

Function	Setting/Execution item	COM object
User defined window - Marker/analysis	Turns on/off bandmarker coupling function	SCPI.CALCulate.USER(1-1).ALLTrace.BDMarker.X.COUPle.STATe
	Turns on/off marker coupling function	SCPI.CALCulate.USER(1-1).ALLTrace.MARKer.COUPle.STATe
	Sets/reads marker movement (Continuous/Discrete)	SCPI.CALCulate.USER(1-1).ALLTrace.MARKer.DISCr ete.STATe
	Sets/reads marker reference number	SCPI.CALCulate.USER(1-1).ALLTrace.MARKer.REFerence.NUMBer
	Turns on/off delta marker mode	SCPI.CALCulate.USER(1-1).ALLTrace.MARKer.REFerence.STATe
	active marker	SCPI.CALCulate.USER(1-1).TRACe(1-8).ALLMarker.ACTive
	marker search X range source	SCPI.CALCulate.USER(1-1).TRACe(1-8).ALLMarker.SEARch.DOMain.X
	marker search Y range source	SCPI.CALCulate.USER(1-1).TRACe(1-8).ALLMarker.SEARch.DOMain.Y
	search peak all	SCPI.CALCulate.USER(1-1).TRACe(1-8).ALLMarker.SEARch.PEAK
	band marker X center	SCPI.CALCulate.USER(1-1).TRACe(1-8).BDMarker.X.CENTer
	band marker X span	SCPI.CALCulate.USER(1-1).TRACe(1-8).BDMarker.X.SPAN
	band marker X start	SCPI.CALCulate.USER(1-1).TRACe(1-8).BDMarker.X.STARt
	band marker visible on/off	SCPI.CALCulate.USER(1-1).TRACe(1-8).BDMarker.X.STATe
	band marker X stop	SCPI.CALCulate.USER(1-1).TRACe(1-8).BDMarker.X.STOP
	band marker Y center	SCPI.CALCulate.USER(1-1).TRACe(1-8).BDMarker.Y.CENTer
	band marker Y span	SCPI.CALCulate.USER(1-1).TRACe(1-8).BDMarker.Y.SPAN
	band marker Y start	SCPI.CALCulate.USER(1-1).TRACe(1-8).BDMarker.Y.STARt
	band marker visible on/off	SCPI.CALCulate.USER(1-1).TRACe(1-8).BDMarker.Y.STATe
	band marker Y stop	SCPI.CALCulate.USER(1-1).TRACe(1-8).BDMarker.Y.STOP
	Sets/reads analysis/search range(x-axis)	SCPI.CALCulate.USER(1-1).TRACe(1-8).FUNCTion.DOMain.X
	Sets/reads analysis/search range(y-axis)	SCPI.CALCulate.USER(1-1).TRACe(1-8).FUNCTion.DOMain.Y
trace data statistics	SCPI.CALCulate.USER(1-1).TRACe(1-8).FUNCTion.STATistics.DATA_Q mean, std_dev, peak_to_peak	

Function	Setting/Execution item	COM object
User defined window - Marker/analysis (Continued)	memory data statistics	SCPI.CALCulate.USER(1-1).TRACe(1-8).FUNCTioN.STATistics.MEMory_Q mean, std_dev, peak_to_peak
	analysis type	SCPI.CALCulate.USER(1-1).TRACe(1-8).FUNCTioN.TYPE
	data hold	SCPI.CALCulate.USER(1-1).TRACe(1-8).HOLD
	Execute marker peak search left	SCPI.CALCulate.USER(1-1).TRACe(1-8).MARKer(1-6).SEARch.EXECute.LPEak
	Execute marker target search left	SCPI.CALCulate.USER(1-1).TRACe(1-8).MARKer(1-6).SEARch.EXECute.LTARget
	Execute marker search maximum	SCPI.CALCulate.USER(1-1).TRACe(1-8).MARKer(1-6).SEARch.EXECute.MAXimum
	Execute marker search minimum	SCPI.CALCulate.USER(1-1).TRACe(1-8).MARKer(1-6).SEARch.EXECute.MINimum
	Execute marker search peak	SCPI.CALCulate.USER(1-1).TRACe(1-8).MARKer(1-6).SEARch.EXECute.PEAK
	Execute marker peak search right	SCPI.CALCulate.USER(1-1).TRACe(1-8).MARKer(1-6).SEARch.EXECute.RPEak
	Execute marker target search right	SCPI.CALCulate.USER(1-1).TRACe(1-8).MARKer(1-6).SEARch.EXECute.RTARget
	Execute marker target search	SCPI.CALCulate.USER(1-1).TRACe(1-8).MARKer(1-6).SEARch.EXECute.TARGet
	Sets/reads the peak excursion value	SCPI.CALCulate.USER(1-1).TRACe(1-8).MARKer(1-6).SEARch.PEAK.EXCursion
	Sets/reads the marker peak-search polarity	SCPI.CALCulate.USER(1-1).TRACe(1-8).MARKer(1-6).SEARch.PEAK.POLarity
	Sets/reads the target transition definition	SCPI.CALCulate.USER(1-1).TRACe(1-8).MARKer(1-6).SEARch.TARGet.TRANsition
	Sets/reads the marker target value	SCPI.CALCulate.USER(1-1).TRACe(1-8).MARKer(1-6).SEARch.TARGet.Y
	Sets/reads the marker tracking type	SCPI.CALCulate.USER(1-1).TRACe(1-8).MARKer(1-6).SEARch.TRACKing.TYPE
	marker visible on/off	SCPI.CALCulate.USER(1-1).TRACe(1-8).MARKer(1-6).STATe
	marker x position	SCPI.CALCulate.USER(1-1).TRACe(1-8).MARKer(1-6).X
	marker y position	SCPI.CALCulate.USER(1-1).TRACe(1-8).MARKer(1-6).Y
	Sets/reads the marker information position	SCPI.DISPlay.USER(1-1).ANNotation.MARKer.POSitioN
Turns on/off the marker list	SCPI.DISPlay.USER(1-1).TABLe.STATe	

COM Object Reference  
List by function

Function	Setting/Execution item	COM object
User defined window - Reads/writes the data	Sets/reads formatted trace data	SCPI.CALCulate.USER(1-1).TRACe(1-8).DATA.FDATA
	Sets/reads formatted memory data	SCPI.CALCulate.USER(1-1).TRACe(1-8).DATA.FMEMORY
	Reads the number of measurement points	SCPI.CALCulate.USER(1-1).TRACe(1-8).DATA.POINTS
	Sets/reads raw data	SCPI.CALCulate.USER(1-1).TRACe(1-8).DATA.RDATA
	start frequency	SCPI.CALCulate.USER(1-1).TRACe(1-8).DATA.START
	stop frequency	SCPI.CALCulate.USER(1-1).TRACe(1-8).DATA.STOP
	Sets/reads unformatted trace data	SCPI.CALCulate.USER(1-1).TRACe(1-8).DATA.UDATA
	Sets/reads unformatted memory data	SCPI.CALCulate.USER(1-1).TRACe(1-8).DATA.UMEMORY
	Sets/reads the X data	SCPI.CALCulate.USER(1-1).TRACe(1-8).DATA.XDATA
VBA Macro	List all the executable macro	SCPI.PROGRAM.CATALOG
	Turns on/off the E5052 VBA event callback function	SCPI.PROGRAM.COM.EVENT
	Sets/reads the name of the program to be selected	SCPI.PROGRAM.SELECTED.NAME
	Set/reads the state of the selected program	SCPI.PROGRAM.SELECTED.STATE
	Turns on/off user defined softkey function	SCPI.PROGRAM.SKEY.ITEM(1-8).ENABLE
	Execute the macro assigned under the user defined softkey	SCPI.PROGRAM.SKEY.ITEM(1-8).IMMEDIATE
	Sets/reads the user defined softkey label	SCPI.PROGRAM.SKEY.ITEM(1-8).LABEL

## List by softkey

Bellow table shows the COM object list by measurement window and softkey.

### FP Menu

Front panel key (Operation)	Function	Corresponding COM Object
<b>Attenuator</b>		
<b>Input Attenuator</b>	Sets/reads Input Attenuator level on 5dB Step	SCPI.SENSE.ATTenuation.LEVel
<b>Average</b>		
<b>Averaging</b>	Turns on/off averaging function	SCPI.SENSE.FP(1-1).AVERAge.STATe
<b>Averaging Restart</b>	Restart averaging	SCPI.SENSE.FP(1-1).AVERAge.CLEAr
<b>Avg Factor</b>	Sets/reads the number of averaging	SCPI.SENSE.FP(1-1).AVERAge.COUNt
<b>DC Control Voltage</b>		
<b>Auto Freq Control</b>		
<b>AFC Status</b>	Turns on/off the auto frequency control function. Executes the auto frequency control once.	SCPI.SOURce.VOLTage.CONTRol.AFC.STATe SCPI.SOURce.VOLTage.CONTRol.AFC.IMMEdiate
<b>Frequency Band</b>	Sets/reads the frequency band in the auto frequency control function	SCPI.SOURce.VOLTage.CONTRol.AFC.FBANd
<b>Max Ctrl Voltage Limit</b>	Sets/reads the maximum DC control voltage limit	SCPI.SOURce.VOLTage.CONTRol.AFC.LIMit.HIGH
<b>Max Iteration</b>	Sets/reads the maximum number of iterations for the DC control voltage-setting loops	SCPI.SOURce.VOLTage.CONTRol.AFC.ITERation
<b>Min Ctrl Voltage Limit</b>	Sets/reads the minimum DC control voltage limit	SCPI.SOURce.VOLTage.CONTRol.AFC.LIMit.LOW
<b>Sensitivity</b>	Sets/reads the tuning sensitivity	SCPI.SOURce.VOLTage.CONTRol.AFC.SENSitivity
<b>Target</b>	Sets/reads the target frequency in the auto frequency control function	SCPI.SOURce.VOLTage.CONTRol.AFC.TARGet
<b>Tolerance</b>	Sets/reads the tolerance limit	SCPI.SOURce.VOLTage.CONTRol.AFC.TOLerance
<b>Control Voltage Cal</b>	Enables DC Control voltage calibration	SCPI.SOURce.VOLTage.CONTRol.CORRection.STATe
<b>DC Control Delay</b>	Sets/reads DC Control delay(sec)	SCPI.SOURce.VOLTage.CONTRol.DELay
<b>DC Control Output</b>	Turns on/off DC Control voltage	SCPI.SOURce.VOLTage.CONTRol.LEVel.STATe
<b>DC Control Voltage</b>	Sets/reads DC Control voltage	SCPI.SOURce.VOLTage.CONTRol.LEVel.AMPLitude

COM Object Reference  
List by softkey

Front panel key (Operation)	Function	Corresponding COM Object
<b>Execute Control Voltage Cal</b>	Execute DC Control voltage calibration	SCPI.SOURce.VOLTage.CONTro l.CORRection.COLLeCt.ACQuire
<b>Max Ctrl Voltage Limit</b>	Sets/reads the maximum DC control voltage limit	SCPI.SOURce.VOLTage.CONTro l.LIMit.HIGH
<b>Min Ctrl Voltage Limit</b>	Sets/reads the minimum DC control voltage limit	SCPI.SOURce.VOLTage.CONTro l.LIMit.LOW
<b>DC Power Voltage</b>		
<b>DC Power Delay</b>	Sets/reads DC Power delay(sec)	SCPI.SOURce.VOLTage.POWer. DELay
<b>DC Power Output</b>	Turns on/off DC Power voltage	SCPI.SOURce.VOLTage.POWer. LEVel.STATe
<b>DC Power Voltage</b>	Sets/reads DC Power voltage	SCPI.SOURce.VOLTage.POWer. LEVel.AMPLitude
<b>Max Pwr Voltage Limit</b>	Sets/reads the maximum DC Power voltage limit	SCPI.SOURce.VOLTage.POWer. LIMit.HIGH
<b>Min Pwr Voltage Limit</b>	Sets/reads the minimum DC Power voltage limit	SCPI.SOURce.VOLTage.POWer. LIMit.LOW
<b>Display</b>		
<b>Allocate</b>	Sets/reads the trace layout	SCPI.DISPlay.FP(1-1).SPLit
<b>Edit Title Label</b>	Edit the measurement window title label	SCPI.DISPlay.FP(1-1).LABel.DA TA
<b>Limit Test</b>		
<b>Delete Lower Limit Line</b>	Clears the lower limit line	SCPI.CALCulate.FP(1-1).TRACe (1-4).LIMit.LOWer.SEGMenT.CL Ear
<b>Delete Upper Limit Line</b>	Clears the upper limit line	SCPI.CALCulate.FP(1-1).TRACe (1-4).LIMit.UPPer.SEGMenT.CL Ear
<b>Explorer</b>		
<b>Fail Sign</b>	Turns on/off the limit test judgement display	SCPI.DISPlay.FP(1-1).LIMit.FSI Gn
<b>Import Lower Limit Line ...</b>	Reads the lower limit line	SCPI.MMEMory.FP(1-1).TRACe (1-4).LOAD.LIMit.LOWer
<b>Import Upper Limit Line ...</b>	Reads the upper limit line	SCPI.MMEMory.FP(1-1).TRACe (1-4).LOAD.LIMit.UPPer
<b>Limit Line</b>	Turns on/off the limit line	SCPI.DISPlay.FP(1-1).TRACe(1- 4).LIMit.LINE
<b>Limit Test</b>	Turns on/off the limit test function	SCPI.CALCulate.FP(1-1).TRACe (1-4).LIMit.STATe
<b>Marker Information</b>	Sets/reads the marker information position	SCPI.DISPlay.FP(1-1).ANNotatio n.MARKer.POSition

Front panel key (Operation)	Function	Corresponding COM Object
<b>Meas Condition</b>	Turns on/off measurement conditions	SCPI.DISPlay.FP(1-1).ANNotatio n.MEASurement.STATe
<b>Relative Y-Scale</b>	Turns on/off relative Y-scale	SCPI.DISPlay.FP(1-1).GRATicule .AXIS.Y.RELative
<b>Title Label</b>	Turns on/off the measurement window title label	SCPI.DISPlay.FP(1-1).LABel.ST ATe
<b>Update</b>	Turns on/off the trace update	SCPI.DISPlay.ENABLE
<b>Y # of Digits</b>	Selects the numberof digits(Y-axis)	SCPI.DISPlay.FP(1-1).GRATicule .AXIS.Y.STATe
<b>Format</b>		
<b>Frequency Format</b>	FP-frequency format	SCPI.CALCulate.FP(1-1).TRACe (1-4).FORMat.FREQuency
<b>Frequency Reference</b>	Sets/reads the frequency reference.	SCPI.CALCulate.FP(1-1).TRACe (1-4).REFerence.FREQuency
<b>Sensitivity Aperture</b>	Sensitivity Aperture	SCPI.CALCulate.FP(1-1).TRACe (1-4).SAPerture
<b>Macro Setup</b>		
<b>E5052 Event</b>	Turns on/off the E5052 VBA event callback function	SCPI.PROGram.COM.EVENTt
<b>Echo Window Menu</b>		
<b>Clear Echo</b>	Clears echo window	SCPI.DISPlay.ECHO.CLEar
<b>Echo Font Size</b>	Sets/reads the font size in Echo window	SCPI.DISPlay.ECHO.FSIZE
<b>Echo Window</b>	Turns on/off the Echo window	SCPI.DISPlay.ECHO.STATe
<b>Load &amp; Run</b>		
<b>Select Macro</b>	Sets/reads the name of the program to be selected	SCPI.PROGram.SELected.NAM E
<b>Stop</b>	Set/reads the state of the selected program	SCPI.PROGram.SELected.STATe
<b>User Menu</b>		
<b>User Label 1</b>	Execute the macro assigned under the user defined softkey	SCPI.PROGram.SKEY.ITEM(1-8 ) IMMEDIATE
<b>User Label 2</b>	Execute the macro assigned under the user defined softkey	SCPI.PROGram.SKEY.ITEM(1-8 ) IMMEDIATE
<b>User Label 3</b>	Execute the macro assigned under the user defined softkey	SCPI.PROGram.SKEY.ITEM(1-8 ) IMMEDIATE
<b>User Label 4</b>	Execute the macro assigned under the user defined softkey	SCPI.PROGram.SKEY.ITEM(1-8 ) IMMEDIATE
<b>User Label 5</b>	Execute the macro assigned under the user defined softkey	SCPI.PROGram.SKEY.ITEM(1-8 ) IMMEDIATE
<b>User Label 6</b>	Execute the macro assigned under the user defined softkey	SCPI.PROGram.SKEY.ITEM(1-8 ) IMMEDIATE

COM Object Reference  
List by softkey

Front panel key (Operation)	Function	Corresponding COM Object
<b>User Label 7</b>	Execute the macro assigned under the user defined softkey	SCPI.PROGRAM.SKEY.ITEM(1-8).IMMEDIATE
<b>User Label 8</b>	Execute the macro assigned under the user defined softkey	SCPI.PROGRAM.SKEY.ITEM(1-8).IMMEDIATE
<b>VBA Editor Menu</b>		
<b>Close Editor</b>	Close VBA editor	
<b>Load Project</b>	Loads program	SCPI.MMEMORY.LOAD.PROGRAM
<b>New Project</b>	Open new VBA project	
<b>Open Editor</b>	Open VBA editor	
<b>Save Project</b>	Save VBA project	SCPI.MMEMORY.STORE.PROGRAM
<b>Marker</b>		
<b>Clear Marker Menu</b>		
<b>All OFF</b>	Clears all the markers	
<b>Marker 1</b>	Turns on/off markers 1	SCPI.CALCULATE.FP(1-1).TRACE(1-4).MARKER(1-6).STATE
<b>Marker 2</b>	Turns on/off markers 2	SCPI.CALCULATE.FP(1-1).TRACE(1-4).MARKER(1-6).STATE
<b>Marker 3</b>	Turns on/off markers 3	SCPI.CALCULATE.FP(1-1).TRACE(1-4).MARKER(1-6).STATE
<b>Marker 4</b>	Turns on/off markers 4	SCPI.CALCULATE.FP(1-1).TRACE(1-4).MARKER(1-6).STATE
<b>Marker 5</b>	Turns on/off markers 5	SCPI.CALCULATE.FP(1-1).TRACE(1-4).MARKER(1-6).STATE
<b>Marker 6</b>	Turns on/off markers 6	SCPI.CALCULATE.FP(1-1).TRACE(1-4).MARKER(1-6).STATE
<b>Couple</b>	Turns on/of marker coupling function	SCPI.CALCULATE.FP(1-1).ALLTRACE.MARKER.COUPLE.STATE
<b>Marker 1</b>	Turns on/off markers 1	SCPI.CALCULATE.FP(1-1).TRACE(1-4).MARKER(1-6).STATE
<b>Marker 2</b>	Turns on/off markers 2	SCPI.CALCULATE.FP(1-1).TRACE(1-4).MARKER(1-6).STATE
<b>Marker 3</b>	Turns on/off markers 3	SCPI.CALCULATE.FP(1-1).TRACE(1-4).MARKER(1-6).STATE
<b>Marker 4</b>	Turns on/off markers 4	SCPI.CALCULATE.FP(1-1).TRACE(1-4).MARKER(1-6).STATE
<b>Marker 5</b>	Turns on/off markers 5	SCPI.CALCULATE.FP(1-1).TRACE(1-4).MARKER(1-6).STATE
<b>Marker 6</b>	Turns on/off markers 6	SCPI.CALCULATE.FP(1-1).TRACE(1-4).MARKER(1-6).STATE



Front panel key (Operation)	Function	Corresponding COM Object
<b>Marker List</b>	Turns on/off the marker list	SCPI.DISPlay.FP(1-1).TABLE.STATe
<b>More Functions</b>		
<b>Discrete</b>	Sets/reads marker movement (Continuous/Discrete)	SCPI.CALCulate.FP(1-1).ALLTrace.MARKer.DISCrete.STATe
<b>Ref Marker</b>	Sets/reads marker reference number	SCPI.CALCulate.FP(1-1).ALLTrace.MARKer.REFerence.NUMBer
<b>Ref Marker Mode</b>	Turns on/off delta marker mode	SCPI.CALCulate.FP(1-1).ALLTrace.MARKer.REFerence.STATe
<b>Marker Function</b>		
<b>Analysis Range (X)</b>	Sets/reads analysis/search range (X-axis)	SCPI.CALCulate.FP(1-1).TRACe(1-4).FUNCTion.DOMain.X
<b>Analysis Range (Y)</b>	Sets/reads analysis/search range (Y-axis)	SCPI.CALCulate.FP(1-1).TRACe(1-4).FUNCTion.DOMain.Y
<b>Analysis Type</b>	Sets/reads analysis type	SCPI.CALCulate.FP(1-1).TRACe(1-4).FUNCTion.TYPE
<b>Band Marker X</b>		
<b>Band Marker X</b>	Turns on/off bandmarker X	SCPI.CALCulate.FP(1-1).TRACe(1-4).BDMarker.X.STATe
<b>Center</b>	Sets/reads the center value of bandmarker X	SCPI.CALCulate.FP(1-1).TRACe(1-4).BDMarker.X.CENTer
<b>Span</b>	Sets/reads the span value of bandmarker X	SCPI.CALCulate.FP(1-1).TRACe(1-4).BDMarker.X.SPAN
<b>Start</b>	Sets/reads the start value of bandmarker X	SCPI.CALCulate.FP(1-1).TRACe(1-4).BDMarker.X.STARt
<b>Stop</b>	Sets/reads the stop value of bandmarker X	SCPI.CALCulate.FP(1-1).TRACe(1-4).BDMarker.X.STOP
<b>Band Marker Y</b>		
<b>Band Marker Y</b>	Turns on/off bandmarker Y	SCPI.CALCulate.FP(1-1).TRACe(1-4).BDMarker.Y.STATe
<b>Center</b>	Sets/reads the center value of bandmarker Y	SCPI.CALCulate.FP(1-1).TRACe(1-4).BDMarker.Y.CENTer
<b>Span</b>	Sets/reads the span value of bandmarker Y	SCPI.CALCulate.FP(1-1).TRACe(1-4).BDMarker.Y.SPAN
<b>Start</b>	Sets/reads the start value of bandmarker Y	SCPI.CALCulate.FP(1-1).TRACe(1-4).BDMarker.Y.STARt
<b>Stop</b>	Sets/reads the stop value of bandmarker Y	SCPI.CALCulate.FP(1-1).TRACe(1-4).BDMarker.Y.STOP
<b>Couple</b>	Turns on/off bandmarker coupling function	SCPI.CALCulate.FP(1-1).ALLTrace.BDMarker.X.COUPle.STATe
<b>Marker Search</b>		

COM Object Reference  
List by softkey

Front panel key (Operation)	Function	Corresponding COM Object
<b>Band Marker X</b>		
<b>Band Marker X</b>	Turns on/off bandmarker X	SCPI.CALCulate.FP(1-1).TRACe (1-4).BDMarker.X.STATe
<b>Center</b>	Sets/reads the center value of bandmarker X	SCPI.CALCulate.FP(1-1).TRACe (1-4).BDMarker.X.CENTer
<b>Span</b>	Sets/reads the span value of bandmarker X	SCPI.CALCulate.FP(1-1).TRACe (1-4).BDMarker.X.SPAN
<b>Start</b>	Sets/reads the start value of bandmarker X	SCPI.CALCulate.FP(1-1).TRACe (1-4).BDMarker.X.STARt
<b>Stop</b>	Sets/reads the stop value of bandmarker X	SCPI.CALCulate.FP(1-1).TRACe (1-4).BDMarker.X.STOP
<b>Band Marker Y</b>		
<b>Band Marker Y</b>	Turns on/off bandmarker Y	SCPI.CALCulate.FP(1-1).TRACe (1-4).BDMarker.Y.STATe
<b>Center</b>	Sets/reads the center value of bandmarker Y	SCPI.CALCulate.FP(1-1).TRACe (1-4).BDMarker.Y.CENTer
<b>Span</b>	Sets/reads the span value of bandmarker Y	SCPI.CALCulate.FP(1-1).TRACe (1-4).BDMarker.Y.SPAN
<b>Start</b>	Sets/reads the start value of bandmarker Y	SCPI.CALCulate.FP(1-1).TRACe (1-4).BDMarker.Y.STARt
<b>Stop</b>	Sets/reads the stop value of bandmarker Y	SCPI.CALCulate.FP(1-1).TRACe (1-4).BDMarker.Y.STOP
<b>Couple</b>	Turns on/off bandmarker coupling function	SCPI.CALCulate.FP(1-1).ALLTra ce.BDMarker.X.COUPle.STATe
<b>Peak</b>		
<b>Peak Excursion</b>	Sets/reads the peak excursion value	SCPI.CALCulate.FP(1-1).TRACe (1-4).MARKer(1-6).SEARch.PE AK.EXCursion
<b>Peak Polarity</b>	Sets/reads the marker peak-search polarity	SCPI.CALCulate.FP(1-1).TRACe (1-4).MARKer(1-6).SEARch.PE AK.POLarity
<b>Search Left</b>	Execute marker peak search left	SCPI.CALCulate.FP(1-1).TRACe (1-4).MARKer(1-6).SEARch.EX ECute.LPEak
<b>Search Peak</b>	Execute marker peak search	SCPI.CALCulate.FP(1-1).TRACe (1-4).MARKer(1-6).SEARch.EX ECute.PEAK
<b>Search Peak All</b>	Execute marker search all	SCPI.CALCulate.FP(1-1).TRACe (1-4).ALLMarker.SEARch.PEAK
<b>Search Right</b>	Execute marker peak search right	SCPI.CALCulate.FP(1-1).TRACe (1-4).MARKer(1-6).SEARch.EX ECute.RPEak

Front panel key (Operation)	Function	Corresponding COM Object
<b>Search Max</b>	Execute marker search maximum	SCPI.CALCulate.FP(1-1).TRACe(1-4).MARKer(1-6).SEARch.EXECute.MAXimum
<b>Search Min</b>	Execute marker search minimum	SCPI.CALCulate.FP(1-1).TRACe(1-4).MARKer(1-6).SEARch.EXECute.MINimum
<b>Search Range (X)</b>	Sets/reads marker search range (X-axis)	SCPI.CALCulate.FP(1-1).TRACe(1-4).ALLMarker.SEARch.DOMain.X
<b>Search Range (Y)</b>	Sets/reads marker search range (Y-axis)	SCPI.CALCulate.FP(1-1).TRACe(1-4).ALLMarker.SEARch.DOMain.Y
<b>Target</b>		
<b>Search Left</b>	Execute marker target search left	SCPI.CALCulate.FP(1-1).TRACe(1-4).MARKer(1-6).SEARch.EXECute.LTARget
<b>Search Right</b>	Execute marker target search right	SCPI.CALCulate.FP(1-1).TRACe(1-4).MARKer(1-6).SEARch.EXECute.RTARget
<b>Search Target</b>	Execute marker target search	SCPI.CALCulate.FP(1-1).TRACe(1-4).MARKer(1-6).SEARch.EXECute.TARGet
<b>Target Transition</b>	Sets/reads the target transition definition	SCPI.CALCulate.FP(1-1).TRACe(1-4).MARKer(1-6).SEARch.TARGet.TRANsition
<b>Target Value</b>	Sets/reads the marker target value	SCPI.CALCulate.FP(1-1).TRACe(1-4).MARKer(1-6).SEARch.TARGet.Y
<b>Tracking</b>	Sets/reads the marker tracking type	SCPI.CALCulate.FP(1-1).TRACe(1-4).MARKer(1-6).SEARch.TRACKing.TYPE
<b>Marker To</b>		
<b>Marker -&gt; Center</b>	Sets the marker value to the center value of DC Control voltage Sets the marker value to the center value of DC Power voltage	SCPI.SOURce.FP(1-1).VOLTage.CONTrol.CENTer SCPI.SOURce.FP(1-1).VOLTage.POWer.CENTer
<b>Marker -&gt; Start</b>	Sets the marker value to the start value of DC Control voltage Sets the marker value to the start value of DC Power voltage	SCPI.SOURce.FP(1-1).VOLTage.CONTrol.START SCPI.SOURce.FP(1-1).VOLTage.POWer.START
<b>Marker -&gt; Stop</b>	Sets the marker value to the stop value of DC Control voltage Sets the marker value to the stop value of DC Power voltage	SCPI.SOURce.FP(1-1).VOLTage.CONTrol.STOP SCPI.SOURce.FP(1-1).VOLTage.POWer.STOP
<b>Measurement View</b>		

COM Object Reference  
List by softkey

Front panel key (Operation)	Function	Corresponding COM Object
<b>Freq &amp; Power</b>	Selects frequency, power & DC current measurement window	SCPI.DISPlay.WINDow.ACTive
<b>Phase Noise</b>	Selects phase noise measurement window	SCPI.DISPlay.WINDow.ACTive
<b>Show Window</b>		
<b>Freq &amp; Power</b>	Turns on/off frequency, power and DC current measurement mode	SCPI.DISPlay.FP(1-1).STATe
<b>Phase Noise</b>	Turns on/off phase noise measurement mode	SCPI.DISPlay.PN(1-1).STATe
<b>Spectrum Monitor</b>	Turns on/off spectrum monitor mode	SCPI.DISPlay.SP(1-1).STATe
<b>Transient</b>	Turns on/off transient measurement mode	SCPI.DISPlay.TR(1-1).STATe
<b>User</b>	Turns on/off user defined window	SCPI.DISPlay.USER(1-1).STATe
<b>Spectrum Monitor</b>	Selects spectrum monitor mode	SCPI.DISPlay.WINDow.ACTive
<b>Transient</b>	Selects transient measurement mode	SCPI.DISPlay.WINDow.ACTive
<b>User</b>	Select user defined window	SCPI.DISPlay.WINDow.ACTive
<b>Preset</b>		
<b>Factory</b>	Preset instrument to the initial setup state	SCPI.SYSTem.PRESet
<b>User</b>	Preset instrument and recalls the Autorec.sta in the F drive	
<b>Save/Recall</b>		
<b>Explorer...</b>	Open windows explorer	
<b>Recall by filename</b>	Recalls state file by file name	SCPI.MMEMory.LOAD.STATe
<b>Recall State</b>		
<b>Autorec</b>	Recalls settings	SCPI.MMEMory.LOAD.STATe
<b>File Dialog...</b>	Open file dialog	
<b>State01</b>	Recalls state file from register 1	SCPI.MMEMory.LOAD.STATe
<b>State02</b>	Recalls state file from register 2	SCPI.MMEMory.LOAD.STATe
<b>State03</b>	Recalls state file from register 3	SCPI.MMEMory.LOAD.STATe
<b>State04</b>	Recalls state file from register 4	SCPI.MMEMory.LOAD.STATe
<b>State05</b>	Recalls state file from register 5	SCPI.MMEMory.LOAD.STATe
<b>State06</b>	Recalls state file from register 6	SCPI.MMEMory.LOAD.STATe
<b>Save Data Trace</b>	Saves trace data	SCPI.MMEMory.FP(1-1).TRACe (1-4).STORe.DATA
<b>Save Memory Trace</b>	Saves memory trace data	SCPI.MMEMory.FP(1-1).TRACe (1-4).STORe.MEMory
<b>Save State</b>		
<b>Autorec</b>	Save settings	SCPI.MMEMory.STORe.STATe
<b>File Dialog...</b>	Open file dialog	
<b>Save Type</b>	Selects instrument state type (Entire or instrument state only)	SCPI.MMEMory.STORe.STYPe

Front panel key (Operation)	Function	Corresponding COM Object
<b>State01</b>	Save state file to register 1	SCPI.MMEMory.STORe.STATe
<b>State02</b>	Save state file to register 2	SCPI.MMEMory.STORe.STATe
<b>State03</b>	Save state file to register 3	SCPI.MMEMory.STORe.STATe
<b>State04</b>	Save state file to register 4	SCPI.MMEMory.STORe.STATe
<b>State05</b>	Save state file to register 5	SCPI.MMEMory.STORe.STATe
<b>State06</b>	Save state file to register 6	SCPI.MMEMory.STORe.STATe
<b>Scale</b>		
<b>Auto Scale</b>	auto scale	SCPI.DISPlay.FP(1-1).TRACe(1-4).Y.SCALe.AUTO
<b>Auto Scale All</b>	Execute autoscale for all traces on frequency, power and DC current measurement window	SCPI.DISPlay.FP(1-1).ALLTrace.Y.SCALe.AUTO
<b>Divisions</b>	Sets/reads Y-scale divisions	SCPI.DISPlay.FP(1-1).Y.SCALe.DIVisions
<b>Marker -&gt; Reference</b>	Set the marker value to the frference level	SCPI.DISPlay.FP(1-1).TRACe(1-4).Y.SCALe.RLEVel
<b>Reference Position</b>	Sets/reads reference position	SCPI.DISPlay.FP(1-1).TRACe(1-4).Y.SCALe.RPOSition
<b>Reference Value</b>	Sets/reads the reference level value	SCPI.DISPlay.FP(1-1).TRACe(1-4).Y.SCALe.RLEVel
<b>Scale/Div</b>	Sets/reads scale per division	SCPI.DISPlay.FP(1-1).TRACe(1-4).Y.SCALe.PDIVision
<b>Setup</b>		
<b>Freq Resolution</b>	Sets/reads frequency resolution	SCPI.SENSE.FP(1-1).FREQUency.RESolution
<b>Frequency Band</b>	Selects frequency band	SCPI.SENSE.FP(1-1).FBANd
<b>Point Delay</b>	Sets/reads the point delay value	SCPI.SENSE.FP(1-1).SWEep.DWELI
<b>Points</b>	Sets/reads the number of measurement points	SCPI.SOURce.FP(1-1).SWEep.POINts
<b>Sweep Parameter</b>	Sets/reads sweep parameter	SCPI.SOURce.FP(1-1).SWEep.PARAmeter
<b>Start/Center</b>		
<b>DC Control Center</b>	Vcontrol center	SCPI.SOURce.FP(1-1).VOLTage.CONTRol.CENTer
<b>DC Control Span</b>	Vcontrol span	SCPI.SOURce.FP(1-1).VOLTage.CONTRol.SPAN
<b>DC Control Start</b>	Vcontrol start	SCPI.SOURce.FP(1-1).VOLTage.CONTRol.STARt
<b>DC Control Stop</b>	Vcontrol stop	SCPI.SOURce.FP(1-1).VOLTage.CONTRol.STOP

COM Object Reference  
List by softkey

Front panel key (Operation)	Function	Corresponding COM Object
<b>DC Power Center</b>	Vpower center	SCPI.SOURce.FP(1-1).VOLTage. POWer.CENTer
<b>DC Power Span</b>	Vpower span	SCPI.SOURce.FP(1-1).VOLTage. POWer.SPAN
<b>DC Power Start</b>	Vpower start	SCPI.SOURce.FP(1-1).VOLTage. POWer.STARt
<b>DC Power Stop</b>	Vpower stop	SCPI.SOURce.FP(1-1).VOLTage. POWer.STOP
<b>Stop/Span</b>		
<b>DC Control Center</b>	Vcontrol center	SCPI.SOURce.FP(1-1).VOLTage. CONTRol.CENTer
<b>DC Control Span</b>	Vcontrol span	SCPI.SOURce.FP(1-1).VOLTage. CONTRol.SPAN
<b>DC Control Start</b>	Vcontrol start	SCPI.SOURce.FP(1-1).VOLTage. CONTRol.STARt
<b>DC Control Stop</b>	Vcontrol stop	SCPI.SOURce.FP(1-1).VOLTage. CONTRol.STOP
<b>DC Power Center</b>	Vpower center	SCPI.SOURce.FP(1-1).VOLTage. POWer.CENTer
<b>DC Power Span</b>	Vpower span	SCPI.SOURce.FP(1-1).VOLTage. POWer.SPAN
<b>DC Power Start</b>	Vpower start	SCPI.SOURce.FP(1-1).VOLTage. POWer.STARt
<b>DC Power Stop</b>	Vpower stop	SCPI.SOURce.FP(1-1).VOLTage. POWer.STOP
<b>System</b>		
<b>Abort Printing</b>	Aborts printing	SCPI.HCOPy.ABORt
<b>Backlight</b>	Turns on/off backlight	SCPI.SYSTem.BACKlight.STATe
<b>Dump Screen Image</b>	Save screen image	SCPI.MMEMory.STORe.IMAGe
<b>Error Log</b>		
<b>Clear Error Log</b>	Clear error log	
<b>View Error Log...</b>	Display error log	
<b>Invert Image</b>	Selects print mode	SCPI.HCOPy.IMAGe
<b>Misc Setup</b>		
<b>Beeper</b>		
<b>Beep Complete</b>	Turns on/off the beep for operation completion	SCPI.SYSTem.BEEPPer.COMPlEt e.STATe
<b>Beep Warning</b>	Turns on/off the beep for warning	SCPI.SYSTem.BEEPPer.WARNing .STATe

Front panel key (Operation)	Function	Corresponding COM Object
<b>Test Beep Complete</b>	Makes beep sound for operation completion	SCPL.SYSTem.BEEPer.COMPlete.IMMEDIATE
<b>Test Beep Warning</b>	Makes beep sound for warning	SCPL.SYSTem.BEEPer.WARNing.IMMEDIATE
<b>Clock Setup</b>		
<b>Set Date and Time</b>	Set/reads system time Set/reads system date	SCPL.SYSTem.TIME[_Q] hour, minute, second SCPL.SYSTem.DATE[_Q] year, month, day
<b>Show Clock</b>	Turns on/off internal clock display	SCPL.DISPlay.CLOCK
<b>Control Panel ...</b>	Open control panel	
<b>GPIB Setup</b>		
<b>System Controller Configuration</b>	Turns on/off system controloer mode	
<b>Talker/Listener Address</b>	Sets the address for controlling the analyzer from a conroller via GPIB	
<b>Key Lock</b>		
<b>Front Panel &amp; Keyboard Lock</b>	Disables from panel keyboard operations	SCPL.SYSTem.KLOCK.KBD
<b>Touch Screen &amp; Mouse Lock</b>	Disables from mouse/touch screen operations	SCPL.SYSTem.KLOCK.MOUSe
<b>Network Setup</b>		
<b>MAC Address</b>	Sets MAC address	
<b>Network Configuration ...</b>	Enables/disables network connections	
<b>Network Identification ...</b>	Sets network ID of the instrument	
<b>SICL-LAN Address</b>	Sets SICL-LAN address	
<b>SICL-LAN Server</b>	Enables/disables SICL-LAN server	
<b>Socket Server</b>	Enables/disables Socket server	
<b>Telnet Server</b>	Enables/disables telnet server	
<b>Print</b>	Outputs print	SCPL.HCOPy.IMMEDIATE
<b>Printer Setup ...</b>	Execute printer setup	
<b>Product Information</b>	Reads product information	
<b>Trace View</b>		

COM Object Reference  
List by softkey

Front panel key (Operation)	Function	Corresponding COM Object
<b>Aperture</b>	Sets/reads smoothing aperture	SCPI.CALCulate.FP(1-1).TRACe(1-4).SMOothing.APERture
<b>Clear Persistent Data</b>	Clear persistence mode	SCPI.DISPlay.FP(1-1).TRACe(1-4).PERSistence.CLEAR
<b>Copy to User</b>	Copies trace data to the user trace	SCPI.CALCulate.FP(1-1).TRACe(1-4).DATA.COPY
<b>Data -&gt; Mem</b>	Copy data trace to memory trace	SCPI.CALCulate.FP(1-1).TRACe(1-4).MATH.MEMorize
<b>Data Hold</b>	Data hold	SCPI.CALCulate.FP(1-1).TRACe(1-4).HOLD
<b>Data Math</b>	Sets/reads math operation type	SCPI.CALCulate.FP(1-1).TRACe(1-4).MATH.FUNcTion
<b>Display Trace</b>	Shows data and/or memory trace	SCPI.DISPlay.FP(1-1).TRACe(1-4).MODE
<b>Persistence Mode</b>	Sets/reads persistence mode	SCPI.DISPlay.FP(1-1).TRACe(1-4).PERSistence.STATe
<b>Smoothing</b>	Turns on/off smoothing	SCPI.CALCulate.FP(1-1).TRACe(1-4).SMOothing.STATe
<b>Trace Label</b>	Edits trace title label	SCPI.DISPlay.FP(1-1).TRACe(1-4).LABel.DATA
<b>Trigger</b>		
<b>Continuous</b>	Sets trigger mode to continuous mode	SCPI.INITiate.FP(1-1).CONTinuous SCPI.INITiate.FP(1-1).IMMediate
<b>Ext Trig Polarity</b>	Sets/reads external trigger polarity	SCPI.TRIGger.EXTernal.SLOPe
<b>Hold</b>	Sets trigger mode to hold	SCPI.INITiate.FP(1-1).IMMediate
<b>Manual Trigger</b>	Execute trigger manually	SCPI.INITiate.FP(1-1).IMMediate
<b>Mode</b>	Sets/reads trigger mode either analyzer mode or tester mode (Analyzer mode is not available when option 011 is installed)	SCPI.TRIGger.FP(1-1).MODE
<b>Restart</b>	Restart trigger	SCPI.INITiate.FP(1-1).IMMediate
<b>Single</b>	Execute trigger once	SCPI.INITiate.FP(1-1).CONTinuous SCPI.INITiate.FP(1-1).IMMediate
<b>Source</b>	Selects trigger source	SCPI.TRIGger.FP(1-1).SOURce
<b>Trigger to Freq &amp; Power</b>	Selects measurement mode to Frequency and power analyzer mode	SCPI.TRIGger.MODE



PN Menu

Front panel key (Operation)	Function	Corresponding COM Object
<b>Attenuator</b>		
Input Attenuator	Sets/reads Input Attenuator level on 5dB Step	SCPI.SENSE.ATTenuation.LEVel
<b>Average</b>		
Averaging	Turns on/off averaging function	SCPI.SENSE.PN(1-1).AVERAge.STATe
Averaging Restart	Restart averaging	SCPI.SENSE.PN(1-1).AVERAge.CLEAr
Avg Factor	Sets/reads average count	SCPI.SENSE.PN(1-1).AVERAge.COUNt
Correlation	Sets/reads the number of correlation	SCPI.SENSE.PN(1-1).CORRelati.on.COUNt
<b>DC Control Voltage</b>		
<b>Auto Freq Control</b>		
AFC Status	Turns on/off the auto frequency control function. Executes the auto frequency control once.	SCPI.SOURce.VOLTage.CONTr ol.AFC.STATe SCPI.SOURce.VOLTage.CONTr ol.AFC.IMMediate
Frequency Band	Sets/reads the frequency band in the auto frequency control function	SCPI.SOURce.VOLTage.CONTr ol.AFC.FBANd
Max Ctrl Voltage Limit	Sets/reads the maximum DC control voltage limit	SCPI.SOURce.VOLTage.CONTr ol.AFC.LIMit.HIGH
Max Iteration	Sets/reads the maximum number of iterations for the DC control voltage-setting loops	SCPI.SOURce.VOLTage.CONTr ol.AFC.ITERation
Min Ctrl Voltage Limit	Sets/reads the minimum DC control voltage limit	SCPI.SOURce.VOLTage.CONTr ol.AFC.LIMit.LOW
Sensitivity	Sets/reads the tuning sensitivity	SCPI.SOURce.VOLTage.CONTr ol.AFC.SENSitivity
Target	Sets/reads the target frequency in the auto frequency control function	SCPI.SOURce.VOLTage.CONTr ol.AFC.TARGet
Tolerance	Sets/reads the tolerance limit	SCPI.SOURce.VOLTage.CONTr ol.AFC.TOLerance
Control Voltage Cal	Enables DC Control voltage calibration	SCPI.SOURce.VOLTage.CONTR ol.CORRection.STATe
DC Control Delay	Sets/reads DC Control delay (sec)	SCPI.SOURce.VOLTage.CONTR ol.DELay
DC Control Output	Turns on/off DC Control voltage	SCPI.SOURce.VOLTage.CONTR ol.LEVel.STATe
DC Control Voltage	Sets/reads DC Control voltage	SCPI.SOURce.VOLTage.CONTR ol.LEVel.AMPLitude

COM Object Reference  
List by softkey

Front panel key (Operation)	Function	Corresponding COM Object
<b>Execute Control Voltage Cal</b>	Execute DC control voltage calibration	SCPI.SOURce.VOLTage.CONTro l.CORRection.COLLeCt.ACQuire
<b>Max Ctrl Voltage Limit</b>	Sets/reads the maximum DC control voltage limit	SCPI.SOURce.VOLTage.CONTro l.LIMit.HIGH
<b>Min Ctrl Voltage Limit</b>	Sets/reads the minimum DC control voltage limit	SCPI.SOURce.VOLTage.CONTro l.LIMit.LOW
<b>DC Power Voltage</b>		
<b>DC Power Delay</b>	Sets/reads DC Power delay (sec)	SCPI.SOURce.VOLTage.POWer. DELay
<b>DC Power Output</b>	Turns on/off DC Power voltage	SCPI.SOURce.VOLTage.POWer. LEVel.STATE
<b>DC Power Voltage</b>	Sets/reads DC Power voltage	SCPI.SOURce.VOLTage.POWer. LEVel.AMPLitude
<b>Max Pwr Voltage Limit</b>	Sets/reads the maximum DC Power voltage limit	SCPI.SOURce.VOLTage.POWer. LIMit.HIGH
<b>Min Pwr Voltage Limit</b>	Sets/reads the minimum DC Power voltage limit	SCPI.SOURce.VOLTage.POWer. LIMit.LOW
<b>Display</b>		
<b>Edit Title Label</b>	Edit the measurement window title label	SCPI.DISPlay.PN(1-1).LABel.DA TA
<b>Limit Test</b>		
<b>Delete Lower Limit Line</b>	Clears the lower limit line	SCPI.CALCulate.PN(1-1).TRACe (1-1).LIMit.LOWer.SEGMent.CL Ear
<b>Delete Upper Limit Line</b>	Clears the upper limit line	SCPI.CALCulate.PN(1-1).TRACe (1-1).LIMit.UPPer.SEGMent.CL Ear
<b>Explorer</b>		
<b>Fail Sign</b>	Turns on/off the limit test judgement display	SCPI.DISPlay.PN(1-1).LIMit.FSI Gn
<b>Import Lower Limit Line ...</b>	Reads the lower limit line	SCPI.MMEMory.PN(1-1).TRACe (1-1).LOAD.LIMit.LOWer
<b>Import Upper Limit Line ...</b>	Reads the upper limit line	SCPI.MMEMory.PN(1-1).TRACe (1-1).LOAD.LIMit.UPPer
<b>Limit Line</b>	Turns on/off the limit line	SCPI.DISPlay.PN(1-1).TRACe(1- 1).LIMit.LINE
<b>Limit Test</b>	Turns on/off the limit test function	SCPI.CALCulate.PN(1-1).TRACe (1-1).LIMit.STATe
<b>Marker Information</b>	Sets/reads the marker information position	SCPI.DISPlay.PN(1-1).ANNotati on.MARKer.POSition
<b>Meas Condition</b>	Turns on/off measurement conditions	SCPI.DISPlay.PN(1-1).ANNotati on.MEASurement.STATe

Front panel key (Operation)	Function	Corresponding COM Object
<b>Relative Y-Scale</b>	Turns on/off relative Y-scale	SCPI.DISPLay.PN(1-1).GRATICul e.AXIS.Y.RELative
<b>Title Label</b>	Turns on/off the measurement window title label	SCPI.DISPLay.PN(1-1).LABel.S TATE
<b>Update</b>	Turns on/off the trace updates	SCPI.DISPLay.ENABLE
<b>Y # of Digits</b>	Selects the number of digits (Y-axis)	SCPI.DISPLay.PN(1-1).GRATICul e.AXIS.Y.STATE
<b>Macro Setup</b>		
<b>E5052 Event</b>	Turns on/off the E5052 VBA event callback function	SCPI.PROGAm.COM.EVENTt
<b>Echo Window Menu</b>		
<b>Clear Echo</b>	Clears echo window	SCPI.DISPLay.ECHO.CLEAr
<b>Echo Font Size</b>	Sets/reads the font size on Echo window	SCPI.DISPLay.ECHO.FSIZE
<b>Echo Window</b>	Turns on./off the Echo window	SCPI.DISPLay.ECHO.STATE
<b>Load &amp; Run</b>		
<b>Select Macro</b>	Sets/reads the name of the program to be selected	SCPI.PROGAm.SELEcted.NAM E
<b>Stop</b>	Set/reads the state of the selected program	SCPI.PROGAm.SELEcted.STATE
<b>User Menu</b>		
<b>User Label 1</b>	Execute the macro assigned under the user defined softkey	SCPI.PROGAm.SKEY.ITEM(1-8 ) IMMEDIATE
<b>User Label 2</b>	Execute the macro assigned under the user defined softkey	SCPI.PROGAm.SKEY.ITEM(1-8 ) IMMEDIATE
<b>User Label 3</b>	Execute the macro assigned under the user defined softkey	SCPI.PROGAm.SKEY.ITEM(1-8 ) IMMEDIATE
<b>User Label 4</b>	Execute the macro assigned under the user defined softkey	SCPI.PROGAm.SKEY.ITEM(1-8 ) IMMEDIATE
<b>User Label 5</b>	Execute the macro assigned under the user defined softkey	SCPI.PROGAm.SKEY.ITEM(1-8 ) IMMEDIATE
<b>User Label 6</b>	Execute the macro assigned under the user defined softkey	SCPI.PROGAm.SKEY.ITEM(1-8 ) IMMEDIATE
<b>User Label 7</b>	Execute the macro assigned under the user defined softkey	SCPI.PROGAm.SKEY.ITEM(1-8 ) IMMEDIATE
<b>User Label 8</b>	Execute the macro assigned under the user defined softkey	SCPI.PROGAm.SKEY.ITEM(1-8 ) IMMEDIATE
<b>VBA Editor Menu</b>		
<b>Close Editor</b>	Close VBA editor	
<b>Load Project</b>	Loads program	SCPI.MMEMory.LOAD.PROGAm
<b>New Project</b>	Open new VBA project	

COM Object Reference  
List by softkey

Front panel key (Operation)	Function	Corresponding COM Object
<b>Open Editor</b>	Open VBA editor	
<b>Save Project</b>	Save VBA project	SCPI.MMEMory.STORe.PROGram
<b>Marker</b>		
<b>Clear Marker Menu</b>		
<b>All OFF</b>	Clears all the markers	
<b>Marker 1</b>	Turns on/off marker 1	SCPI.CALCulate.PN(1-1).TRACe(1-1).MARKer(1-6).STATe
<b>Marker 2</b>	Turns on/off marker 2	SCPI.CALCulate.PN(1-1).TRACe(1-1).MARKer(1-6).STATe
<b>Marker 3</b>	Turns on/off marker 3	SCPI.CALCulate.PN(1-1).TRACe(1-1).MARKer(1-6).STATe
<b>Marker 4</b>	Turns on/off marker 4	SCPI.CALCulate.PN(1-1).TRACe(1-1).MARKer(1-6).STATe
<b>Marker 5</b>	Turns on/off marker 5	SCPI.CALCulate.PN(1-1).TRACe(1-1).MARKer(1-6).STATe
<b>Marker 6</b>	Turns on/off marker 6	SCPI.CALCulate.PN(1-1).TRACe(1-1).MARKer(1-6).STATe
<b>Marker 1</b>	Turns on/off marker 1	SCPI.CALCulate.PN(1-1).TRACe(1-1).MARKer(1-6).STATe
<b>Marker 2</b>	Turns on/off marker 2	SCPI.CALCulate.PN(1-1).TRACe(1-1).MARKer(1-6).STATe
<b>Marker 3</b>	Turns on/off marker 3	SCPI.CALCulate.PN(1-1).TRACe(1-1).MARKer(1-6).STATe
<b>Marker 4</b>	Turns on/off marker 4	SCPI.CALCulate.PN(1-1).TRACe(1-1).MARKer(1-6).STATe
<b>Marker 5</b>	Turns on/off marker 5	SCPI.CALCulate.PN(1-1).TRACe(1-1).MARKer(1-6).STATe
<b>Marker 6</b>	Turns on/off marker 6	SCPI.CALCulate.PN(1-1).TRACe(1-1).MARKer(1-6).STATe
<b>Marker List</b>	Turns on/off the marker list	SCPI.DISPlay.PN(1-1).TABLe.STATe
<b>More Functions</b>		
<b>Discrete</b>	Sets/reads marker movement (Continuous/Discrete)	SCPI.CALCulate.PN(1-1).ALLTrace.MARKer.DISCrete.STATe
<b>Ref Marker</b>	Sets/reads marker reference number	SCPI.CALCulate.PN(1-1).ALLTrace.MARKer.REFerence.NUMBer
<b>Ref Marker Mode</b>	Turns on/off delta marker mode	SCPI.CALCulate.PN(1-1).ALLTrace.MARKer.REFerence.STATe
<b>Marker Function</b>		

Front panel key (Operation)	Function	Corresponding COM Object
<b>Analysis Range (X)</b>	Sets/reads analysis/search range (X-axis)	SCPI.CALCulate.PN(1-1).TRACe(1-1).FUNction.DOMain.X
<b>Analysis Range (Y)</b>	Sets/reads analysis/search range (Y-axis)	SCPI.CALCulate.PN(1-1).TRACe(1-1).FUNction.DOMain.Y
<b>Analysis Type</b>	Sets/reads analysis type	SCPI.CALCulate.PN(1-1).TRACe(1-1).FUNction.TYPE
<b>Band Marker X</b>		
<b>Band Marker X</b>	Turns on/off bandmarker X	SCPI.CALCulate.PN(1-1).TRACe(1-1).BDMarker.X.STATE
<b>Center</b>	Sets/reads the center value of bandmarker X	SCPI.CALCulate.PN(1-1).TRACe(1-1).BDMarker.X.CENTer
<b>Span</b>	Sets/reads the span value of bandmarker X	SCPI.CALCulate.PN(1-1).TRACe(1-1).BDMarker.X.SPAN
<b>Start</b>	Sets/reads the start value of bandmarker X	SCPI.CALCulate.PN(1-1).TRACe(1-1).BDMarker.X.START
<b>Stop</b>	Sets/reads the stop value of bandmarker X	SCPI.CALCulate.PN(1-1).TRACe(1-1).BDMarker.X.STOP
<b>Band Marker Y</b>		
<b>Band Marker Y</b>	Turns on/off bandmarker Y	SCPI.CALCulate.PN(1-1).TRACe(1-1).BDMarker.Y.STATE
<b>Center</b>	Sets/reads the center value of bandmarker Y	SCPI.CALCulate.PN(1-1).TRACe(1-1).BDMarker.Y.CENTer
<b>Span</b>	Sets/reads the span value of bandmarker Y	SCPI.CALCulate.PN(1-1).TRACe(1-1).BDMarker.Y.SPAN
<b>Start</b>	Sets/reads the start value of bandmarker Y	SCPI.CALCulate.PN(1-1).TRACe(1-1).BDMarker.Y.START
<b>Stop</b>	Sets/reads the stop value of bandmarker Y	SCPI.CALCulate.PN(1-1).TRACe(1-1).BDMarker.Y.STOP
<b>Marker Search</b>		
<b>Band Marker X</b>		
<b>Band Marker X</b>	Turns on/off bandmarker X	SCPI.CALCulate.PN(1-1).TRACe(1-1).BDMarker.X.STATE
<b>Center</b>	Sets/reads the center value of bandmarker X	SCPI.CALCulate.PN(1-1).TRACe(1-1).BDMarker.X.CENTer
<b>Span</b>	Sets/reads the span value of bandmarker X	SCPI.CALCulate.PN(1-1).TRACe(1-1).BDMarker.X.SPAN
<b>Start</b>	Sets/reads the start value of bandmarker X	SCPI.CALCulate.PN(1-1).TRACe(1-1).BDMarker.X.START
<b>Stop</b>	Sets/reads the stop value of bandmarker X	SCPI.CALCulate.PN(1-1).TRACe(1-1).BDMarker.X.STOP
<b>Band Marker Y</b>		

COM Object Reference  
List by softkey

Front panel key (Operation)	Function	Corresponding COM Object
<b>Band Marker Y</b>	Turns on/off bandmarker Y	SCPI.CALCulate.PN(1-1).TRACe(1-1).BDMarker.Y.STATe
<b>Center</b>	Sets/reads the center value of bandmarker Y	SCPI.CALCulate.PN(1-1).TRACe(1-1).BDMarker.Y.CENTer
<b>Span</b>	Sets/reads the span value of bandmarker Y	SCPI.CALCulate.PN(1-1).TRACe(1-1).BDMarker.Y.SPAN
<b>Start</b>	Sets/reads the start value of bandmarker Y	SCPI.CALCulate.PN(1-1).TRACe(1-1).BDMarker.Y.STARt
<b>Stop</b>	Sets/reads the stop value of bandmarker Y	SCPI.CALCulate.PN(1-1).TRACe(1-1).BDMarker.Y.STOP
<b>Peak</b>		
<b>Peak Excursion</b>	Sets/reads the peak excursion value	SCPI.CALCulate.PN(1-1).TRACe(1-1).MARKer(1-6).SEARch.PEAK.EXCursion
<b>Peak Polarity</b>	Sets/reads the marker peak-search polarity	SCPI.CALCulate.PN(1-1).TRACe(1-1).MARKer(1-6).SEARch.PEAK.POLarity
<b>Search Left</b>	Execute marker peak search left	SCPI.CALCulate.PN(1-1).TRACe(1-1).MARKer(1-6).SEARch.EXECute.LPEak
<b>Search Peak</b>	Execute marker peak search	SCPI.CALCulate.PN(1-1).TRACe(1-1).MARKer(1-6).SEARch.EXECute.PEAK
<b>Search Peak All</b>	Execute marker search all	SCPI.CALCulate.PN(1-1).TRACe(1-1).ALLMarker.SEARch.PEAK
<b>Search Right</b>	Execute marker peak search right	SCPI.CALCulate.PN(1-1).TRACe(1-1).MARKer(1-6).SEARch.EXECute.RPEak
<b>Search Max</b>	Execute marker search maximum	SCPI.CALCulate.PN(1-1).TRACe(1-1).MARKer(1-6).SEARch.EXECute.MAXimum
<b>Search Min</b>	Execute marker search minimum	SCPI.CALCulate.PN(1-1).TRACe(1-1).MARKer(1-6).SEARch.EXECute.MINimum
<b>Search Range (X)</b>	Sets/reads marker search range (X-axis)	SCPI.CALCulate.PN(1-1).TRACe(1-1).ALLMarker.SEARch.DOMa in.X
<b>Search Range (Y)</b>	Sets/reads marker search range (Y-axis)	SCPI.CALCulate.PN(1-1).TRACe(1-1).ALLMarker.SEARch.DOMa in.Y
<b>Target</b>		
<b>Search Left</b>	Execute marker target search left	SCPI.CALCulate.PN(1-1).TRACe(1-1).MARKer(1-6).SEARch.EXECute.LTARget

Front panel key (Operation)	Function	Corresponding COM Object
<b>Search Right</b>	Execute marker target search right	SCPI.CALCulate.PN(1-1).TRACe(1-1).MARKer(1-6).SEARch.EXECute.RTARget
<b>Search Target</b>	Execute marker target search	SCPI.CALCulate.PN(1-1).TRACe(1-1).MARKer(1-6).SEARch.EXECute.TARGet
<b>Target Transition</b>	Sets/reads the target transition definition	SCPI.CALCulate.PN(1-1).TRACe(1-1).MARKer(1-6).SEARch.TARGet.TRANSition
<b>Target Value</b>	Sets/reads the marker target value	SCPI.CALCulate.PN(1-1).TRACe(1-1).MARKer(1-6).SEARch.TARGet.Y
<b>Tracking</b>	Sets/reads the marker tracking type	SCPI.CALCulate.PN(1-1).TRACe(1-1).MARKer(1-6).SEARch.TRACKing.TYPE
<b>Marker To</b>		
<b>Marker -&gt; Start</b>	Sets/reads the marker value to the start value	SCPI.SENSE.PN(1-1).FREQuency.STARt
<b>Marker -&gt; Stop</b>	Sets/reads the marker value to the stop value	SCPI.SENSE.PN(1-1).FREQuency.STOP
<b>Measurement View</b>		
<b>Freq &amp; Power</b>	Selects frequency, power and DC current measurement window	SCPI.DISPlay.WINDow.ACTive
<b>Phase Noise</b>	Selects phase noise measurement window	SCPI.DISPlay.WINDow.ACTive
<b>Show Window</b>		
<b>Freq &amp; Power</b>	Turns on/off frequency, power and DC current measurement mode	SCPI.DISPlay.FP(1-1).STATe
<b>Phase Noise</b>	Turns on/off phase noise measurement mode	SCPI.DISPlay.PN(1-1).STATe
<b>Spectrum Monitor</b>	Turns on/off spectrum monitor mode	SCPI.DISPlay.SP(1-1).STATe
<b>Transient</b>	Turns on/off transient measurement mode	SCPI.DISPlay.TR(1-1).STATe
<b>User</b>	Turns on/off user defined window	SCPI.DISPlay.USER(1-1).STATe
<b>Spectrum Monitor</b>	Selects spectrum monitor mode	SCPI.DISPlay.WINDow.ACTive
<b>Transient</b>	Selects transient measurement mode	SCPI.DISPlay.WINDow.ACTive
<b>User</b>	Selects user defined window	SCPI.DISPlay.WINDow.ACTive
<b>Preset</b>		
<b>Factory</b>	Preset instrument to the initial setup state	SCPI.SYSTem.PRESet
<b>User</b>	Preset instrument and recalls the Autorec.sta in the F drive	
<b>Save/Recall</b>		
<b>Explorer...</b>	Open windows explorer	
<b>Recall by filename</b>	Recalls state file by file name	SCPI.MMEMory.LOAD.STATe

COM Object Reference  
List by softkey

Front panel key (Operation)	Function	Corresponding COM Object
<b>Recall State</b>		
<b>Autorec</b>	Recalls settings	SCPI.MMEMory.LOAD.STATe
<b>File Dialog...</b>	Open file dialog	
<b>State01</b>	Recalls state file from register 1	SCPI.MMEMory.LOAD.STATe
<b>State02</b>	Recalls state file from register 2	SCPI.MMEMory.LOAD.STATe
<b>State03</b>	Recalls state file from register 3	SCPI.MMEMory.LOAD.STATe
<b>State04</b>	Recalls state file from register 4	SCPI.MMEMory.LOAD.STATe
<b>State05</b>	Recalls state file from register 5	SCPI.MMEMory.LOAD.STATe
<b>State06</b>	Recalls state file from register 6	SCPI.MMEMory.LOAD.STATe
<b>Save Data Trace</b>	Saves trace data	SCPI.MMEMory.PN(1-1).TRACe(1-1).STORe.DATA
<b>Save Memory Trace</b>	Saves memory trace data	SCPI.MMEMory.PN(1-1).TRACe(1-1).STORe.MEMory
<b>Save State</b>		
<b>Autorec</b>	Save settings	SCPI.MMEMory.STORe.STATe
<b>File Dialog...</b>	Open file dialog	
<b>Save Type</b>	Select instrument state type (Entire or instrument state only)	SCPI.MMEMory.STORe.STYPe
<b>State01</b>	Save state file to register 1	SCPI.MMEMory.STORe.STATe
<b>State02</b>	Save state file to register 2	SCPI.MMEMory.STORe.STATe
<b>State03</b>	Save state file to register 3	SCPI.MMEMory.STORe.STATe
<b>State04</b>	Save state file to register 4	SCPI.MMEMory.STORe.STATe
<b>State05</b>	Save state file to register 5	SCPI.MMEMory.STORe.STATe
<b>State06</b>	Save state file to register 6	SCPI.MMEMory.STORe.STATe
<b>Scale</b>		
<b>Auto Scale</b>	Execute autoscale	SCPI.DISPlay.PN(1-1).TRACe(1-1).Y.SCALe.AUTO
<b>Divisions</b>	Sets/reads Y-scale divisions	SCPI.DISPlay.PN(1-1).Y.SCALe.DIVisions
<b>Marker -&gt; Reference</b>	Sets the marker value to the reference level	SCPI.DISPlay.PN(1-1).TRACe(1-1).Y.SCALe.RLEVel
<b>Reference Position</b>	Sets/reads reference position	SCPI.DISPlay.PN(1-1).TRACe(1-1).Y.SCALe.RPOStion
<b>Reference Value</b>	Sets/reads the reference level value	SCPI.DISPlay.PN(1-1).TRACe(1-1).Y.SCALe.RLEVel
<b>Scale/Div</b>	Sets/reads scale per division	SCPI.DISPlay.PN(1-1).TRACe(1-1).Y.SCALe.PDIVision
<b>Setup</b>		



Front panel key (Operation)	Function	Corresponding COM Object
<b>Frequency Band</b>	Selects frequency band	SCPI.SENSE.PN(1-1).FBAND
<b>IF Gain</b>	Sets/reads the IF Gain	SCPI.SENSE.PN(1-1).IFGain
<b>LO PhNoise Optimize</b>	Sets/reads phase noise Local bandwidth optimization.	SCPI.SENSE.PN(1-1).LOBandwidth
<b>Measurement Quality</b>	Sets/reads the quality level.	SCPI.SENSE.PN(1-1).SEGTable.MEASurement.QUALity
<b>Start</b>		
<b>100Hz</b>	Sets 100Hz to the start frequency	SCPI.SENSE.PN(1-1).FREQuency.START
<b>10Hz</b>	Sets 10Hz to the start frequency	SCPI.SENSE.PN(1-1).FREQuency.START
<b>1Hz</b>	Sets 1Hz to the start frequency	SCPI.SENSE.PN(1-1).FREQuency.START
<b>1kHz</b>	Sets 1kHz to the start frequency	SCPI.SENSE.PN(1-1).FREQuency.START
<b>Stop</b>		
<b>100kHz</b>	Sets 100kHz to the stop frequency	SCPI.SENSE.PN(1-1).FREQuency.STOP
<b>10MHz</b>	Sets 10MHz to the stop frequency	SCPI.SENSE.PN(1-1).FREQuency.STOP
<b>1MHz</b>	Sets 1MHz to the stop frequency	SCPI.SENSE.PN(1-1).FREQuency.STOP
<b>40MHz</b>	Sets 40MHz to the stop frequency	SCPI.SENSE.PN(1-1).FREQuency.STOP
<b>5MHz</b>	Sets 5MHz to the stop frequency	SCPI.SENSE.PN(1-1).FREQuency.STOP
<b>System</b>		
<b>Abort Printing</b>	Aborts printing	SCPI.HCOPy.ABORt
<b>Backlight</b>	Turns on/off backlight	SCPI.SYSTem.BACKlight.STATe
<b>Dump Screen Image</b>	Save screen image	SCPI.MMEMory.STORe.IMAGe
<b>Error Log</b>		
<b>Clear Error Log</b>	Clear error log	
<b>View Error Log...</b>	Display error log	
<b>Invert Image</b>	Selects print mode	SCPI.HCOPy.IMAGe
<b>Misc Setup</b>		
<b>Beeper</b>		
<b>Beep Complete</b>	Turns on/off the beep for operation completion	SCPI.SYSTem.BEEPPer.COMPLet e.STATe

COM Object Reference  
List by softkey

Front panel key (Operation)	Function	Corresponding COM Object
<b>Beep Warning</b>	Turns on/off the beep for warning	SCPI.SYSem.BEEPer.WARning.STATe
<b>Test Beep Complete</b>	Makes beep sound for operation completion	SCPI.SYSem.BEEPer.COMPLete.IMMediate
<b>Test Beep Warning</b>	Makes beep sound for warning	SCPI.SYSem.BEEPer.WARning.IMMediate
<b>Clock Setup</b>		
<b>Set Date and Time</b>	Set/reads system time Set/reads system date	SCPI.SYSem.TIME[_Q] hour , minute , second SCPI.SYSem.DATE[_Q] year , month , day
<b>Show Clock</b>	Turns on/off internal clock display	SCPI.DISPlay.CLOCK
<b>Control Panel ...</b>	Open control panel	
<b>GPIB Setup</b>		
<b>System Controller Configuration</b>	Turns on/off system controller mode	
<b>Talker/Listener Address</b>	Sets/the address for controlling the analyzer from a controller via GPIB	
<b>Key Lock</b>		
<b>Front Panel &amp; Keyboard Lock</b>	Disables from panel/keyboard operations	SCPI.SYSem.KLOCK.KBD
<b>Touch Screen &amp; Mouse Lock</b>	Disables from touch screen/mouse operations	SCPI.SYSem.KLOCK.MOUSE
<b>Network Setup</b>		
<b>MAC Address</b>	Sets MAC address	
<b>Network Configuration ...</b>	Enables/disables network connections	
<b>Network Identification ...</b>	Sets network ID of the instrument	
<b>SICL-LAN Address</b>	Sets SICL-LAN address	
<b>SICL-LAN Server</b>	Enables/disables SICL-LAN server	
<b>Socket Server</b>	Enables/disables Socket server	
<b>Telnet Server</b>	Enables/disables Telnet server	
<b>Print</b>	Outputs print	SCPI.HCOPY.IMMediate
<b>Printer Setup ...</b>	Executes printer setup	

Front panel key (Operation)	Function	Corresponding COM Object
<b>Product Information</b>	Reads product information	
<b>Trace View</b>		
<b>Aperture</b>	Smoothing aperture	SCPI.CALCulate.PN(1-1).TRACe(1-1).SMOothing.APERture
<b>Clear Persistent Data</b>	Clears persistence mode	SCPI.DISPlay.PN(1-1).TRACe(1-1).PERSistence.CLEAR
<b>Copy to User</b>	Copies trace data to the user trace	SCPI.CALCulate.PN(1-1).TRACe(1-1).DATA.COPY
<b>Data -&gt; Mem</b>	Copy data to memory	SCPI.CALCulate.PN(1-1).TRACe(1-1).MATH.MEMorize
<b>Data Hold</b>	Data hold	SCPI.CALCulate.PN(1-1).TRACe(1-1).HOLD
<b>Data Math</b>	Sets/reads math operation type	SCPI.CALCulate.PN(1-1).TRACe(1-1).MATH.FUNCTION
<b>Display Trace</b>	Shows data and/or memory trace	SCPI.DISPlay.PN(1-1).TRACe(1-1).MODE
<b>Omitting Spurious</b>	Spurious display omission ON/OFF	SCPI.CALCulate.PN(1-1).TRACe(1-1).SPURious.OMISSion
<b>Persistence Mode</b>	Sets/reads persistence mode	SCPI.DISPlay.PN(1-1).TRACe(1-1).PERSistence.STATe
<b>Smoothing</b>	Smoothing on/off	SCPI.CALCulate.PN(1-1).TRACe(1-1).SMOothing.STATe
<b>Spurious</b>		
<b>Clear Threshold Table</b>	Clears the threshold data	SCPI.CALCulate.PN(1-1).TRACe(1-1).SPURious.THReshold.TABLe.CLEAR
<b>Import Threshold Table ...</b>	Reads the threshold data	SCPI.MMEMory.PN(1-1).TRACe(1-1).LOAD.SPURious.THReshold
<b>Normalized (dBc/Hz)</b>	Disables the spurious power value display	SCPI.CALCulate.PN(1-1).TRACe(1-1).SPURious.POWER SCPI.CALCulate.PN(1-1).TRACe(1-1).SPURious.OMISSion
<b>Omit</b>	Enables the spurious display omission	SCPI.CALCulate.PN(1-1).TRACe(1-1).SPURious.OMISSion
<b>Power (dBc)</b>	Enables the spurious power value display	SCPI.CALCulate.PN(1-1).TRACe(1-1).SPURious.POWER
<b>Spurious List</b>	Display the spurious data	
<b>Trace Label</b>	Edit trace title label	SCPI.DISPlay.PN(1-1).TRACe(1-1).LABel.DATA
<b>Trigger</b>		

COM Object Reference  
List by softkey

Front panel key (Operation)	Function	Corresponding COM Object
<b>Continuous</b>	Sets trigger mode to continuous mode	SCPI.INITiate.PN(1-1).CONTinuous SCPI.INITiate.PN(1-1).IMMediate
<b>Ext Trig Polarity</b>	Sets/reads external trigger polarity	SCPI.TRIGger.EXTernal.SLOPe
<b>Hold</b>	Sets trigger mode to hold	SCPI.INITiate.PN(1-1).IMMediate
<b>Manual Trigger</b>	Execute trigger manually	SCPI.INITiate.PN(1-1).IMMediate
<b>Restart</b>	Restart trigger	SCPI.INITiate.PN(1-1).IMMediate
<b>Single</b>	Execute trigger once	SCPI.INITiate.PN(1-1).CONTinuous SCPI.INITiate.PN(1-1).IMMediate
<b>Source</b>	Sets/reads trigger source	SCPI.TRIGger.PN(1-1).SOURce
<b>Trigger to Phase Noise</b>	Sets measurement mode to phase noise mode	SCPI.TRIGger.MODE

SP Menu

Front panel key (Operation)	Function	Corresponding COM Object
<b>Attenuator</b>		
Input Attenuator	Sets/reads Input Attenuator level at 5dB Step	SCPI.SENSE.ATTenuation.LEVel
<b>Average/BW</b>		
Averaging	Turns on/off averaging function	SCPI.SENSE.SP(1-1).AVERAge.STATe
Averaging Restart	Restart averaging	SCPI.SENSE.SP(1-1).AVERAge.CLEAr
Averaging Type	Sets/reads averaging type	SCPI.SENSE.SP(1-1).AVERAge.TYPE
Avg Factor	Sets/reads the averaging count	SCPI.SENSE.SP(1-1).AVERAge.COUNt
RBW	Sets/reads RBW value	SCPI.SENSE.SP(1-1).BANDwidth.RESOulution
<b>DC Control Voltage</b>		
<b>Auto Freq Control</b>		
AFC Status	Turns on/off the auto frequency control function. Executes the auto frequency control once.	SCPI.SOURce.VOLTage.CONTRol.AFC.STATe SCPI.SOURce.VOLTage.CONTRol.AFC.IMMediate
Frequency Band	Sets/reads the frequency band in the auto frequency control function	SCPI.SOURce.VOLTage.CONTRol.AFC.FBAND
Max Ctrl Voltage Limit	Sets/reads the maximum DC control voltage limit	SCPI.SOURce.VOLTage.CONTRol.AFC.LIMit.HIGH
Max Iteration	Sets/reads the maximum number of iterations for the DC control voltage-setting loops	SCPI.SOURce.VOLTage.CONTRol.AFC.ITERation
Min Ctrl Voltage Limit	Sets/reads the minimum DC control voltage limit	SCPI.SOURce.VOLTage.CONTRol.AFC.LIMit.LOW
Sensitivity	Sets/reads the tuning sensitivity	SCPI.SOURce.VOLTage.CONTRol.AFC.SENSitivity
Target	Sets/reads the target frequency in the auto frequency control function	SCPI.SOURce.VOLTage.CONTRol.AFC.TARGet
Tolerance	Sets/reads the tolerance limit	SCPI.SOURce.VOLTage.CONTRol.AFC.TOLerance
Control Voltage Cal	Enables DC Control voltage calibration	SCPI.SOURce.VOLTage.CONTRol.CORRection.STATe
DC Control Delay	Sets/reads DC Control delay (sec)	SCPI.SOURce.VOLTage.CONTRol.DELay
DC Control Output	Turns on/off DC Control voltage	SCPI.SOURce.VOLTage.CONTRol.LEVel.STATe

COM Object Reference  
List by softkey

Front panel key (Operation)	Function	Corresponding COM Object
<b>DC Control Voltage</b>	Sets/reads DC Control voltage	SCPI.SOURce.VOLTage.CONTRo l.LEVel.AMPLitude
<b>Execute Control Voltage Cal</b>	Execute DC Control voltage calibration	SCPI.SOURce.VOLTage.CONTRo l.CORRection.COLLect.ACQuire
<b>Max Ctrl Voltage Limit</b>	Sets/reads the maximum DC Control voltage limit	SCPI.SOURce.VOLTage.CONTRo l.LIMit.HIGH
<b>Min Ctrl Voltage Limit</b>	Sets/reads the minimum DC Control voltage limit	SCPI.SOURce.VOLTage.CONTRo l.LIMit.LOW
<b>DC Power Voltage</b>		
<b>DC Power Delay</b>	Sets/reads DC Power delay (sec)	SCPI.SOURce.VOLTage.POWer. DELay
<b>DC Power Output</b>	Turns on/off DC Power voltage	SCPI.SOURce.VOLTage.POWer. LEVel.STAtE
<b>DC Power Voltage</b>	Sets/reads DC Power voltage	SCPI.SOURce.VOLTage.POWer. LVEl.AMPLitude
<b>Max Pwr Voltage Limit</b>	Sets/reads the maximum DC Power voltage limit	SCPI.SOURce.VOLTage.POWer. LIMit.HIGH
<b>Min Pwr Voltage Limit</b>	Sets/reads the minimum DC Power voltage limit	SCPI.SOURce.VOLTage.POWer. LIMit.LOW
<b>Display</b>		
<b>Edit Title Label</b>	Edits the measurement window title label	SCPI.DISPlay.SP(1-1).LABel.DA TA
<b>Limit Test</b>		
<b>Delete Lower Limit Line</b>	Clears the lower limit line	SCPI.CALCulate.SP(1-1).TRACe (1-1).LIMit.LOWer.SEGMent.CL Ear
<b>Delete Upper Limit Line</b>	Clears the upper limit line	SCPI.CALCulate.SP(1-1).TRACe (1-1).LIMit.UPPer.SEGMent.CL Ear
<b>Explorer</b>		
<b>Fail Sign</b>	Turns on/off the limit test judgement display	SCPI.DISPlay.SP(1-1).LIMit.FSI Gn
<b>Import Lower Limit Line ...</b>	Reads the lower limit line	SCPI.MMEMory.SP(1-1).TRACe (1-1).LOAD.LIMit.LOWer
<b>Import Upper Limit Line ...</b>	Reads the upper limit line	SCPI.MMEMory.SP(1-1).TRACe (1-1).LOAD.LIMit.UPPer
<b>Limit Line</b>	Turns on/off the limit line	SCPI.DISPlay.SP(1-1).TRACe(1- 1).LIMit.LINE
<b>Limit Test</b>	Turns on/off the limit test function	SCPI.CALCulate.SP(1-1).TRACe (1-1).LIMit.STAtE
<b>Marker Information</b>	Sets/reads the marker information position	SCPI.DISPlay.SP(1-1).ANNotatio n.MARKer.POSition

Front panel key (Operation)	Function	Corresponding COM Object
<b>Meas Condition</b>	Turns on/off measurement conditions	SCPI.DISPlay.SP(1-1).ANNOtation.MEASurement.STATe
<b>Relative Y-Scale</b>	Turns on/off relative Y-scale	SCPI.DISPlay.SP(1-1).GRATICule.AXIS.Y.RELative
<b>Title Label</b>	Turns on/off measurement window title label	SCPI.DISPlay.SP(1-1).LABel.STATe
<b>Update</b>	Turns on/off trace updates	SCPI.DISPlay.ENABLE
<b>Y # of Digits</b>	Selects the number of digits (Y-axis)	SCPI.DISPlay.SP(1-1).GRATICule.AXIS.Y.STATe
<b>Format</b>		
<b>Detector Mode</b>	Sets/reads the detector mode	SCPI.SENSE.SP(1-1).DETEctor.FUNction
<b>Format</b>	Sets/reads Y-axis unit on spectrum monitor mode	SCPI.CALCulate.SP(1-1).TRACe(1-1).FORMat
<b>Macro Setup</b>		
<b>E5052 Event</b>	Turns on/off the E5052 VBA event callback function	SCPI.PROGram.COM.EVENTt
<b>Echo Window Menu</b>		
<b>Clear Echo</b>	Clears Echo window	SCPI.DISPlay.ECHO.CLEar
<b>Echo Font Size</b>	Sets/reads the font size on Echo window	SCPI.DISPlay.ECHO.FSIZE
<b>Echo Window</b>	Turns on/off the Echo window	SCPI.DISPlay.ECHO.STATe
<b>Load &amp; Run</b>	Load and execute the macro selected on file names.	
<b>Select Macro</b>	Sets/reads the name of the program to be selected	SCPI.PROGram.SELEcted.NAMe
<b>Stop</b>	Set/reads the state of the selected program	SCPI.PROGram.SELEcted.STATe
<b>User Menu</b>		
<b>User Label 1</b>	Execute the macro assigned under the user defined softkey	SCPI.PROGram.SKEY.ITEM(1-8).IMMediate
<b>User Label 2</b>	Execute the macro assigned under the user defined softkey	SCPI.PROGram.SKEY.ITEM(1-8).IMMediate
<b>User Label 3</b>	Execute the macro assigned under the user defined softkey	SCPI.PROGram.SKEY.ITEM(1-8).IMMediate
<b>User Label 4</b>	Execute the macro assigned under the user defined softkey	SCPI.PROGram.SKEY.ITEM(1-8).IMMediate
<b>User Label 5</b>	Execute the macro assigned under the user defined softkey	SCPI.PROGram.SKEY.ITEM(1-8).IMMediate
<b>User Label 6</b>	Execute the macro assigned under the user defined softkey	SCPI.PROGram.SKEY.ITEM(1-8).IMMediate
<b>User Label 7</b>	Execute the macro assigned under the user defined softkey	SCPI.PROGram.SKEY.ITEM(1-8).IMMediate

COM Object Reference  
List by softkey

Front panel key (Operation)	Function	Corresponding COM Object
<b>User Label 8</b>	Execute the macro assigned under the user defined softkey	SCPI.PROGRAM.SKEY.ITEM(1-8).IMMEDIATE
<b>VBA Editor Menu</b>		
<b>Close Editor</b>	Close VBA editor	
<b>Load Project</b>	Loads program	SCPI.MMEMORY.LOAD.PROGRAM
<b>New Project</b>	Open new VBA project	
<b>Open Editor</b>	Open VBA editor	
<b>Save Project</b>	Save VBA project	SCPI.MMEMORY.STORE.PROGRAM
<b>Marker</b>		
<b>Clear Marker Menu</b>		
<b>All OFF</b>	Clears all the markers	
<b>Marker 1</b>	Turns on/off marker 1	SCPI.CALCULATE.SP(1-1).TRACE(1-1).MARKER(1-6).STATE
<b>Marker 2</b>	Turns on/off marker 2	SCPI.CALCULATE.SP(1-1).TRACE(1-1).MARKER(1-6).STATE
<b>Marker 3</b>	Turns on/off marker 3	SCPI.CALCULATE.SP(1-1).TRACE(1-1).MARKER(1-6).STATE
<b>Marker 4</b>	Turns on/off marker 4	SCPI.CALCULATE.SP(1-1).TRACE(1-1).MARKER(1-6).STATE
<b>Marker 5</b>	Turns on/off marker 5	SCPI.CALCULATE.SP(1-1).TRACE(1-1).MARKER(1-6).STATE
<b>Marker 6</b>	Turns on/off marker 6	SCPI.CALCULATE.SP(1-1).TRACE(1-1).MARKER(1-6).STATE
<b>Marker 1</b>	Turns on/off marker 1	SCPI.CALCULATE.SP(1-1).TRACE(1-1).MARKER(1-6).STATE
<b>Marker 2</b>	Turns on/off marker 2	SCPI.CALCULATE.SP(1-1).TRACE(1-1).MARKER(1-6).STATE
<b>Marker 3</b>	Turns on/off marker 3	SCPI.CALCULATE.SP(1-1).TRACE(1-1).MARKER(1-6).STATE
<b>Marker 4</b>	Turns on/off marker 4	SCPI.CALCULATE.SP(1-1).TRACE(1-1).MARKER(1-6).STATE
<b>Marker 5</b>	Turns on/off marker 5	SCPI.CALCULATE.SP(1-1).TRACE(1-1).MARKER(1-6).STATE
<b>Marker 6</b>	Turns on/off marker 6	SCPI.CALCULATE.SP(1-1).TRACE(1-1).MARKER(1-6).STATE
<b>Marker List</b>	Turns on/off the marker list	SCPI.DISPLAY.SP(1-1).TABLE.STATE
<b>More Functions</b>		



Front panel key (Operation)	Function	Corresponding COM Object
<b>Discrete</b>	Sets/reads marker movement (Continuous/Discrete)	SCPI.CALCulate.SP(1-1).ALLTrace.MARKer.DISCrete.STATe
<b>Ref Marker</b>	Sets/reads marker reference number	SCPI.CALCulate.SP(1-1).ALLTrace.MARKer.REFerence.NUMBer
<b>Ref Marker Mode</b>	Turns on/off delta marker mode	SCPI.CALCulate.SP(1-1).ALLTrace.MARKer.REFerence.STATe
<b>Marker Function</b>		
<b>Analysis Range (X)</b>	Sets/reads analysis/search range (X-axis)	SCPI.CALCulate.SP(1-1).TRACe(1-1).FUNCTion.DOMain.X
<b>Analysis Range (Y)</b>	Sets/reads analysis/search range (Y-axis)	SCPI.CALCulate.SP(1-1).TRACe(1-1).FUNCTion.DOMain.Y
<b>Analysis Type</b>	Sets/reads analysis type	SCPI.CALCulate.SP(1-1).TRACe(1-1).FUNCTion.TYPE
<b>Band Marker X</b>		
<b>Band Marker X</b>	Turns on/off bandmarker X	SCPI.CALCulate.SP(1-1).TRACe(1-1).BDMarker.X.STATe
<b>Center</b>	Sets/reads the center value of bandmarker X	SCPI.CALCulate.SP(1-1).TRACe(1-1).BDMarker.X.CENTer
<b>Span</b>	Sets/reads the span value of bandmarker X	SCPI.CALCulate.SP(1-1).TRACe(1-1).BDMarker.X.SPAN
<b>Start</b>	Sets/reads the start value of bandmarker X	SCPI.CALCulate.SP(1-1).TRACe(1-1).BDMarker.X.STARt
<b>Stop</b>	Sets/reads the stop value of bandmarker X	SCPI.CALCulate.SP(1-1).TRACe(1-1).BDMarker.X.STOP
<b>Band Marker Y</b>		
<b>Band Marker Y</b>	Turns on/off bandmarker Y	SCPI.CALCulate.SP(1-1).TRACe(1-1).BDMarker.Y.STATe
<b>Center</b>	Sets/reads the center value of bandmarker Y	SCPI.CALCulate.SP(1-1).TRACe(1-1).BDMarker.Y.CENTer
<b>Span</b>	Sets/reads the span value of bandmarker Y	SCPI.CALCulate.SP(1-1).TRACe(1-1).BDMarker.Y.SPAN
<b>Start</b>	Sets/reads the start value of bandmarker Y	SCPI.CALCulate.SP(1-1).TRACe(1-1).BDMarker.Y.STARt
<b>Stop</b>	Sets/reads the stop value of bandmarker Y	SCPI.CALCulate.SP(1-1).TRACe(1-1).BDMarker.Y.STOP
<b>Marker Search</b>		
<b>Band Marker X</b>		
<b>Band Marker X</b>	Turns on/off bandmarker X	SCPI.CALCulate.SP(1-1).TRACe(1-1).BDMarker.X.STATe
<b>Center</b>	Sets/reads the center value of bandmarker X	SCPI.CALCulate.SP(1-1).TRACe(1-1).BDMarker.X.CENTer

COM Object Reference  
List by softkey

Front panel key (Operation)	Function	Corresponding COM Object
<b>Span</b>	Sets/reads the span value of bandmarker X	SCPI.CALCulate.SP(1-1).TRACe(1-1).BDMarker.X.SPAN
<b>Start</b>	Sets/reads the start value of bandmarker X	SCPI.CALCulate.SP(1-1).TRACe(1-1).BDMarker.X.STARt
<b>Stop</b>	Sets/reads the stop value of bandmarker X	SCPI.CALCulate.SP(1-1).TRACe(1-1).BDMarker.X.STOP
<b>Band Marker Y</b>		
<b>Band Marker Y</b>	Turns on/off bandmarker Y	SCPI.CALCulate.SP(1-1).TRACe(1-1).BDMarker.Y.STATe
<b>Center</b>	Sets/reads the center value of bandmarker Y	SCPI.CALCulate.SP(1-1).TRACe(1-1).BDMarker.Y.CENTer
<b>Span</b>	Sets/reads the span value of bandmarker Y	SCPI.CALCulate.SP(1-1).TRACe(1-1).BDMarker.Y.SPAN
<b>Start</b>	Sets/reads the start value of bandmarker Y	SCPI.CALCulate.SP(1-1).TRACe(1-1).BDMarker.Y.STARt
<b>Stop</b>	Sets/reads the stop value of bandmarker Y	SCPI.CALCulate.SP(1-1).TRACe(1-1).BDMarker.Y.STOP
<b>Peak</b>		
<b>Peak Excursion</b>	Sets/reads the peak excursion value	SCPI.CALCulate.SP(1-1).TRACe(1-1).MARKer(1-6).SEARch.PEAK.EXCursion
<b>Peak Polarity</b>	Sets/reads the marker peak-search polarity	SCPI.CALCulate.SP(1-1).TRACe(1-1).MARKer(1-6).SEARch.PEAK.POLarity
<b>Search Left</b>	Execute marker peak search left	SCPI.CALCulate.SP(1-1).TRACe(1-1).MARKer(1-6).SEARch.EXECute.LPEak
<b>Search Peak</b>	Execute marker peak search	SCPI.CALCulate.SP(1-1).TRACe(1-1).MARKer(1-6).SEARch.EXECute.PEAK
<b>Search Peak All</b>	Execute marker search all	SCPI.CALCulate.SP(1-1).TRACe(1-1).ALLMarker.SEARch.PEAK
<b>Search Right</b>	Execute marker peak search right	SCPI.CALCulate.SP(1-1).TRACe(1-1).MARKer.(1-6).SEARch.EXECute.RPEak
<b>Search Max</b>	Execute marker search maximum	SCPI.CALCulate.SP(1-1).TRACe(1-1).MARKer(1-6).SEARch.EXECute.MAXimum
<b>Search Min</b>	Execute marker search minimum	SCPI.CALCulate.SP(1-1).TRACe(1-1).MARKer(1-6).SEARch.EXECute.MINimum
<b>Search Range (X)</b>	Sets/reads marker search range (X-axis)	SCPI.CALCulate.SP(1-1).TRACe(1-1).ALLMarker.SEARch.DOMain.X

Front panel key (Operation)	Function	Corresponding COM Object
<b>Search Range (Y)</b>	Sets/reads marker search range (Y-axis)	SCPI.CALCulate.SP(1-1).TRACe(1-1).ALLMarker.SEARCh.DOMain.Y
<b>Target</b>		
<b>Search Left</b>	Execute marker target search left	SCPI.CALCulate.SP(1-1).TRACe(1-1).MARKer(1-6).SEARCh.EXECute.LTARget
<b>Search Right</b>	Execute marker target search right	SCPI.CALCulate.SP(1-1).TRACe(1-1).MARKer(1-6).SEARCh.EXECute.RTARget
<b>Search Target</b>	Execute marker target search	SCPI.CALCulate.SP(1-1).TRACe(1-1).MARKer(1-6).SEARCh.EXECute.TARGet
<b>Target Transition</b>	Sets/reads the target transition definition	SCPI.CALCulate.SP(1-1).TRACe(1-1).MARKer(1-6).SEARCh.TARGet.TRANsition
<b>Target Value</b>	Sets/reads the marker target value	SCPI.CALCulate.SP(1-1).TRACe(1-1).MARKer(1-6).SEARCh.TARGet.Y
<b>Tracking</b>	Sets/reads the marker tracking type	SCPI.CALCulate.SP(1-1).TRACe(1-1).MARKer(1-6).SEARCh.TRACking.TYpe
<b>Marker To</b>		
<b>Marker -&gt; Center</b>	Sets/reads the center value of frequency span	SCPI.SENSE.SP(1-1).FREQUency.CENTer
<b>Marker -&gt; Start</b>	Sets/reads the start value of frequency span	SCPI.SENSE.SP(1-1).FREQUency.START
<b>Marker -&gt; Stop</b>	Sets/reads the stop value of frequency span	SCPI.SENSE.SP(1-1).FREQUency.STOP
<b>Measurement View</b>		
<b>Freq &amp; Power</b>	Selects frequency, power and DC current measurement window	SCPI.DISPlay.WINDow.ACTive
<b>Phase Noise</b>	Selects phase noise measurement window	SCPI.DISPlay.WINDow.ACTive
<b>Show Window</b>		
<b>Freq &amp; Power</b>	Turn on/off frequency, power and DC current measurement mode	SCPI.DISPlay.FP(1-1).STATe
<b>Phase Noise</b>	Turns on/off phase noise measurement mode	SCPI.DISPlay.PN(1-1).STATe
<b>Spectrum Monitor</b>	Turns on/off spectrum monitor mode	SCPI.DISPlay.SP(1-1).STATe
<b>Transient</b>	Turns on/off transient measurement mode	SCPI.DISPlay.TR(1-1).STATe
<b>User</b>	Turns on/off user defined window	SCPI.DISPlay.USER(1-1).STATe
<b>Spectrum Monitor</b>	Selects spectrum monitor mode	SCPI.DISPlay.WINDow.ACTive
<b>Transient</b>	Selects transient measurement mode	SCPI.DISPlay.WINDow.ACTive

COM Object Reference  
List by softkey

Front panel key (Operation)	Function	Corresponding COM Object
<b>User</b>	Selects user defined window	SCPI.DISPlay.WINDow.ACTive
<b>Preset</b>		
<b>Factory</b>	Preset instrument to the initial setup state	SCPI.SYSTem.PRESet
<b>User</b>	Preset instrument and recalls the Autorec.sta in the F drive	
<b>Save/Recall</b>		
<b>Explorer...</b>	Open windows explorer	
<b>Recall by filename</b>	Recalls state file by file name	SCPI.MMEMory.LOAD.STATe
<b>Recall State</b>		
<b>Autorec</b>	Recalls settings	SCPI.MMEMory.LOAD.STATe
<b>File Dialog...</b>	Open file dialog	
<b>State01</b>	Recalls state file from register 1	SCPI.MMEMory.LOAD.STATe
<b>State02</b>	Recalls state file from register 2	SCPI.MMEMory.LOAD.STATe
<b>State03</b>	Recalls state file from register 3	SCPI.MMEMory.LOAD.STATe
<b>State04</b>	Recalls state file from register 4	SCPI.MMEMory.LOAD.STATe
<b>State05</b>	Recalls state file from register 5	SCPI.MMEMory.LOAD.STATe
<b>State06</b>	Recalls state file from register 6	SCPI.MMEMory.LOAD.STATe
<b>Save Data Trace</b>	Saves trace data	SCPI.MMEMory.SP(1-1).TRACe(1-1).STORe.DATA
<b>Save Memory Trace</b>	Saves memory trace data	SCPI.MMEMory.SP(1-1).TRACe(1-1).STORe.MEMory
<b>Save State</b>		
<b>Autorec</b>	Save settings	SCPI.MMEMory.STORe.STATe
<b>File Dialog...</b>	Open file dialog	
<b>Save Type</b>	Select instrument state type (Entire or instrument state only)	SCPI.MMEMory.STORe.STYPe
<b>State01</b>	Save state file to register 1	SCPI.MMEMory.STORe.STATe
<b>State02</b>	Save state file to register 2	SCPI.MMEMory.STORe.STATe
<b>State03</b>	Save state file to register 3	SCPI.MMEMory.STORe.STATe
<b>State04</b>	Save state file to register 4	SCPI.MMEMory.STORe.STATe
<b>State05</b>	Save state file to register 5	SCPI.MMEMory.STORe.STATe
<b>State06</b>	Save state file to register 6	SCPI.MMEMory.STORe.STATe
<b>Scale</b>		
<b>Auto Scale</b>	Execute autoscale	SCPI.DISPlay.SP(1-1).TRACe(1-1).Y.SCALe.AUTO
<b>Divisions</b>	Sets/reads Y-scale divisions	SCPI.DISPlay.SP(1-1).Y.SCALe.DIVisions

Front panel key (Operation)	Function	Corresponding COM Object
<b>Marker -&gt; Reference</b>	Sets the marker value to the reference level	SCPL.DISPlay.SP(1-1).TRACe(1-1).Y.SCALe.RLEVel
<b>Reference Position</b>	Sets/reads the reference position	SCPL.DISPlay.SP(1-1).TRACe(1-1).Y.SCALe.RPOStion
<b>Reference Value</b>	Sets/reads the reference level value	SCPL.DISPlay.SP(1-1).TRACe(1-1).Y.SCALe.RLEVel
<b>Scale/Div</b>	Sets/reads scale per division	SCPL.DISPlay.SP(1-1).TRACe(1-1).Y.SCALe.PDIVision
<b>Setup</b>		
<b>Reference Level</b>	Sets/reads the reference level of frequency span	SCPL.SENSE.SP(1-1).POWer.RLEVel
<b>Start/Center</b>		
<b>Carrier To</b>		
<b>Carrier -&gt; Center</b>	Changes the center frequency to the carrier frequency.	SCPL.SENSE.SP(1-1).CARRier.SET.CENTer
<b>Carrier x 2 -&gt; Center</b>	Changes the center frequency to 2 times the carrier frequency.	SCPL.SENSE.SP(1-1).CARRier.SET.CENTer
<b>Carrier x 3 -&gt; Center</b>	Changes the center frequency to 3 times the carrier frequency.	SCPL.SENSE.SP(1-1).CARRier.SET.CENTer
<b>Carrier x # -&gt; Center</b>	Changes the center frequency to # times the carrier frequency. (The # is assigned by <b>Harmonic #</b> key.)	SCPL.SENSE.SP(1-1).CARRier.SET.CENTer
<b>Frequency Band</b>	Sets/reads the carrier frequency band.	SCPL.SENSE.SP(1-1).CARRier.FBAND
<b>Harmonic #</b>	Sets the magnification of carrier frequency when center frequency is set.	
<b>Center</b>	Sets/reads the center value of frequency span	SCPL.SENSE.SP(1-1).FREQUency.CENTer
<b>Span</b>	Sets/reads the span value of frequency span	SCPL.SENSE.SP(1-1).FREQUency.SPAN
<b>Start</b>	Sets/reads the start value of frequency span	SCPL.SENSE.SP(1-1).FREQUency.STARt
<b>Stop</b>	Sets/reads the stop value of frequency span	SCPL.SENSE.SP(1-1).FREQUency.STOP
<b>Stop/Span</b>		
<b>Carrier To</b>		
<b>Carrier -&gt; Center</b>	Changes the center frequency to the carrier frequency.	SCPL.SENSE.SP(1-1).CARRier.SET.CENTer
<b>Carrier x 2 -&gt; Center</b>	Changes the center frequency to 2 times the carrier frequency.	SCPL.SENSE.SP(1-1).CARRier.SET.CENTer
<b>Carrier x 3 -&gt; Center</b>	Changes the center frequency to 3 times the carrier frequency.	SCPL.SENSE.SP(1-1).CARRier.SET.CENTer

COM Object Reference  
List by softkey

Front panel key (Operation)	Function	Corresponding COM Object
<b>Carrier x # -&gt; Center</b>	Changes the center frequency to # times the carrier frequency. (The # is assigned by <b>Harmonic #</b> key.)	SCPI.SENSE.SP(1-1).CARRIER.SET.CENTER
<b>Frequency Band</b>	Sets/reads the carrier frequency band.	SCPI.SENSE.SP(1-1).CARRIER.FBAND
<b>Harmonic #</b>	Sets the magnification of carrier frequency when center frequency is set.	
<b>Center</b>	Sets/reads the center value of frequency span	SCPI.SENSE.SP(1-1).FREQUENCY.CENTER
<b>Span</b>	Sets/reads the span value of frequency span	SCPI.SENSE.SP(1-1).FREQUENCY.SPAN
<b>Start</b>	Sets/reads the start value of frequency span	SCPI.SENSE.SP(1-1).FREQUENCY.START
<b>Stop</b>	Sets/reads the stop value of frequency span	SCPI.SENSE.SP(1-1).FREQUENCY.STOP
<b>System</b>		
<b>Abort Printing</b>	Aborts printing	SCPI.HCOPY.ABORT
<b>Backlight</b>	Turns on/off backlight	SCPI.SYSTEM.BACKLIGHT.STATE
<b>Dump Screen Image</b>	Save screen image	SCPI.MMEMORY.STORE.IMAGE
<b>Error Log</b>		
<b>Clear Error Log</b>	Clear error log	
<b>View Error Log...</b>	Display error log	
<b>Invert Image</b>	Selects print mode	SCPI.HCOPY.IMAGE
<b>Misc Setup</b>		
<b>Beeper</b>		
<b>Beep Complete</b>	Turns on/off the beep for operation completion	SCPI.SYSTEM.BEEPER.COMPLET.E.STATE
<b>Beep Warning</b>	Turns on/off the beep for warning	SCPI.SYSTEM.BEEPER.WARNING.STATE
<b>Test Beep Complete</b>	Makes beep sound for operation completion	SCPI.SYSTEM.BEEPER.COMPLET.E.IMMEDIATE
<b>Test Beep Warning</b>	Makes beep sound for warning	SCPI.SYSTEM.BEEPER.WARNING.IMMEDIATE
<b>Clock Setup</b>		
<b>Set Date and Time</b>	Set/reads system time Set/reads system date	SCPI.SYSTEM.TIME[_Q] hour , minute , second SCPI.SYSTEM.DATE[_Q] year , month , day
<b>Show Clock</b>	Turns on/off internal clock display	SCPI.DISPLAY.CLOCK
<b>Control Panel ...</b>	Open control panel	
<b>GPIB Setup</b>		

Front panel key (Operation)	Function	Corresponding COM Object
<b>System Controller Configuration</b>	Turns on/off system controller mode	
<b>Talker/Listener Address</b>	Sets the address for controlling the analyzer from a controller via GPIB.	
<b>Key Lock</b>		
<b>Front Panel &amp; Keyboard Lock</b>	Disables from panel / keyboard operations	SCPI.SYSTem.KLOCK.KBD
<b>Touch Screen &amp; Mouse Lock</b>	Disables from touch screen / mouse operations	SCPI.SYSTem.KLOCK.MOUSe
<b>Network Setup</b>		
<b>MAC Address</b>	Sets MAC address	
<b>Network Configuration ...</b>	Enables/disables network connections	
<b>Network Identification ...</b>	Sets network ID of the instrument	
<b>SICL-LAN Address</b>	Sets SICL-LAN address	
<b>SICL-LAN Server</b>	Enables/disables SICL-LAN server	
<b>Socket Server</b>	Enables/disables Socket server	
<b>Telnet Server</b>	Enables/disables Telnet server	
<b>Print</b>	Outputs print	SCPI.HCOPy.IMMEDIATE
<b>Printer Setup ...</b>	Execute printer setup	
<b>Product Information</b>	Reads product information	
<b>Trace View</b>		
<b>Aperture</b>	Smoothing aperture	SCPI.CALCulate.SP(1-1).TRACe(1-1).SMOothing.APERture
<b>Clear Persistent Data</b>	Clears persistence mode	SCPI.DISPlay.SP(1-1).TRACe(1-1).PERSistence.CLEAr
<b>Copy to User</b>	Copies trace data to the user trace	SCPI.CALCulate.SP(1-1).TRACe(1-1).DATA.COPY
<b>Data -&gt; Mem</b>	Copy data to memory	SCPI.CALCulate.SP(1-1).TRACe(1-1).MATH.MEMorize
<b>Data Hold</b>	Data hold	SCPI.CALCulate.SP(1-1).TRACe(1-1).HOLD
<b>Data Math</b>	Sets/reads math operation type	SCPI.CALCulate.SP(1-1).TRACe(1-1).MATH.FUNCTION

COM Object Reference  
List by softkey

Front panel key (Operation)	Function	Corresponding COM Object
<b>Display Trace</b>	Shows data and/or memory trace	SCPI.DISPlay.SP(1-1).TRACe(1-1).MODE
<b>Persistence Mode</b>	Sets/reads persistence mode	SCPI.DISPlay.SP(1-1).TRACe(1-1).PERSistence.STATe
<b>Smoothing</b>	Smoothing on/off	SCPI.CALCulate.SP(1-1).TRACe(1-1).SMOothing.STATe
<b>Trace Label</b>	Edits trace title label	SCPI.DISPlay.SP(1-1).TRACe(1-1).LABel.DATA
<b>Trigger</b>		
<b>Continuous</b>	Sets/reads trigger mode to continuous mode	SCPI.INITiate.SP(1-1).CONTinuous SCPI.INITiate.SP(1-1).IMMediate
<b>Ext Trig Polarity</b>	Sets/reads external trigger polarity	SCPI.TRIGger.EXTernal.SLOPe
<b>Hold</b>	Sets trigger mode to hold	SCPI.INITiate.SP(1-1).IMMediate
<b>Manual Trigger</b>	Execute a trigger manually	SCPI.INITiate.SP(1-1).IMMediate
<b>Restart</b>	Restart trigger	SCPI.INITiate.SP(1-1).IMMediate
<b>Single</b>	Execute trigger once	SCPI.INITiate.SP(1-1).CONTinuous SCPI.INITiate.SP(1-1).IMMediate
<b>Source</b>	Selects trigger source	SCPI.TRIGger.SP(1-1).SOURce
<b>Trigger to Spectrum Monitor</b>	Sets measurement mode to spectrum monitor mode	SCPI.TRIGger.MODE



TR Menu

Front panel key (Operation)	Function	Corresponding COM Object
<b>Attenuator</b>		
<b>Input Attenuator</b>	Sets/reads Input Attenuator level at 5dB Step	SCPI.SENSE.ATTenuation.LEVel
<b>Average</b>		
<b>Averaging</b>	Turn on/off averaging function	SCPI.SENSE.TR(1-1).AVERAge.STATe
<b>Averaging Restart</b>	Restart averaging	SCPI.SENSE.TR(1-1).AVERAge.CLear
<b>Avg Factor</b>	Sets/reads averaging count	SCPI.SENSE.TR(1-1).AVERAge.COUnT
<b>DC Control Voltage</b>		
<b>Auto Freq Control</b>		
<b>AFC Status</b>	Turns on/off the auto frequency control function. Executes the auto frequency control once.	SCPI.SOURce.VOLTage.CONTRol.AFC.STATe SCPI.SOURce.VOLTage.CONTRol.AFC.IMMediate
<b>Frequency Band</b>	Sets/reads the frequency band in the auto frequency control function	SCPI.SOURce.VOLTage.CONTRol.AFC.FBANd
<b>Max Ctrl Voltage Limit</b>	Sets/reads the maximum DC control voltage limit	SCPI.SOURce.VOLTage.CONTRol.AFC.LIMit.HIGH
<b>Max Iteration</b>	Sets/reads the maximum number of iterations for the DC control voltage-setting loops	SCPI.SOURce.VOLTage.CONTRol.AFC.ITERation
<b>Min Ctrl Voltage Limit</b>	Sets/reads the minimum DC control voltage limit	SCPI.SOURce.VOLTage.CONTRol.AFC.LIMit.LOW
<b>Sensitivity</b>	Sets/reads the tuning sensitivity	SCPI.SOURce.VOLTage.CONTRol.AFC.SENSitivity
<b>Target</b>	Sets/reads the target frequency in the auto frequency control function	SCPI.SOURce.VOLTage.CONTRol.AFC.TARGet
<b>Tolerance</b>	Sets/reads the tolerance limit	SCPI.SOURce.VOLTage.CONTRol.AFC.TOLerance
<b>Control Voltage Cal</b>	Enables DC Control voltage calibration	SCPI.SOURce.VOLTage.CONTRol.CORRection.STATe
<b>DC Control Delay</b>	Sets/reads DC Control delay (sec)	SCPI.SOURce.VOLTage.CONTRol.DELay
<b>DC Control Output</b>	Turns on/off DC Control voltage	SCPI.SOURce.VOLTage.CONTRol.LEVel.STATe
<b>DC Control Voltage</b>	Sets/reads DC Control voltage	SCPI.SOURce.VOLTage.CONTRol.LEVel.AMPLitude
<b>Execute Control Voltage Cal</b>	Execute DC Control voltage calibration	SCPI.SOURce.VOLTage.CONTRol.CORRection.COLLECT.ACQUIRE

COM Object Reference  
List by softkey

Front panel key (Operation)	Function	Corresponding COM Object
<b>Max Ctrl Voltage Limit</b>	Sets/reads the maximum DC control voltage limit	SCPI.SOURce.VOLTage.CONTRol.LIMit.HIGH
<b>Min Ctrl Voltage Limit</b>	Sets/reads the minimum DC control voltage limit	SCPI.SOURce.VOLTage.CONTRol.LIMit.LOW
<b>DC Power Voltage</b>		
<b>DC Power Delay</b>	Sets/reads DC Power delay (sec)	SCPI.SOURce.VOLTage.POWer.DE Lay
<b>DC Power Output</b>	Turns on/off DC Power voltage	SCPI.SOURce.VOLTage.POWer.LE Vel.STATE
<b>DC Power Voltage</b>	Sets/reads DC Power voltage	SCPI.SOURce.VOLTage.POWer.LE Vel.AMPLitude
<b>Max Pwr Voltage Limit</b>	Sets/reads the maximum DC Power voltage limit	SCPI.SOURce.VOLTage.POWer.LIMit.HIGH
<b>Min Pwr Voltage Limit</b>	Sets/reads the minimum DC Power voltage limit	SCPI.SOURce.VOLTage.POWer.LIMit.LOW
<b>Display</b>		
<b>Edit Title Label</b>	Edits the measurement window title label	SCPI.DISPlay.TR(1-1).LABel.DAT A
<b>Limit Test</b>		
<b>Delete Lower Limit Line</b>	Clears the lower limit line	SCPI.CALCulate.TR(1-1).TRACe(1-4).LIMit.LOWer.SEGMent.CLEar
<b>Delete Upper Limit Line</b>	Clears the upper limit line	SCPI.CALCulate.TR(1-1).TRACe(1-4).LIMit.UPPer.SEGMent.CLEar
<b>Explorer</b>		
<b>Fail Sign</b>	Turns on/off the limit test judgement display	SCPI.DISPlay.TR(1-1).LIMit.FSIGN
<b>Import Lower Limit Line ...</b>	Reads the lower limit line	SCPI.MMEMory.TR(1-1).TRACe(1-4).LOAD.LIMit.LOWer
<b>Import Upper Limit Line ...</b>	Reads the upper limit line	SCPI.MMEMory.TR(1-1).TRACe(1-4).LOAD.LIMit.UPPer
<b>Limit Line</b>	Turns on/off the limit line	SCPI.DISPlay.TR(1-1).TRACe(1-4).LIMit.LINE
<b>Limit Test</b>	Turns on/off the limit test function	SCPI.CALCulate.TR(1-1).TRACe(1-4).LIMit.STATE
<b>Marker Information</b>	Sets/reads the marker information position	SCPI.DISPlay.TR(1-1).ANNotation.MARKer.POSition
<b>Meas Condition</b>	Turns on/off measurement conditions	SCPI.DISPlay.TR(1-1).ANNotation.MEASurement.STATE
<b>Relative Y-Scale</b>	Turns on/off relative Y-scale	SCPI.DISPlay.TR(1-1).GRATICule.AXIS.Y.RELative
<b>Title Label</b>	Turns on/off the measurement window title lable	SCPI.DISPlay.TR(1-1).LABel.STAT e

Front panel key (Operation)	Function	Corresponding COM Object
<b>Update</b>	Turns on/off trace updates	SCPI.DISPlay.ENABLE
<b>Y # of Digits</b>	Selects the number of digits (Y-axis)	SCPI.DISPlay.TR(1-1).GRATicule.AXIS.Y.STATE
<b>Format</b>		
<b>Frequency Format</b>	Sets/reads the frequency format	SCPI.CALCulate.TR(1-1).TRACe(1-4).FORMat.FREQuency
<b>Frequency Reference</b>	Sets/reads the reference frequency	SCPI.CALCulate.TR(1-1).TRACe(1-4).REFerence.FREQuency
<b>Phase Unit</b>	Selects phase format on transient measurement	SCPI.CALCulate.TR(1-1).TRACe(1-4).FORMat.PHASE.UNIT
<b>Wrap Phase</b>	Turns on/off wrap-phase	SCPI.CALCulate.TR(1-1).TRACe(1-4).FORMat.PHASE.WRAP
<b>Macro Setup</b>		
<b>E5052 Event</b>	Turns on/off the E5052 VBA event callback function	SCPI.PROGram.COM.EVENT
<b>Echo Window Menu</b>		
<b>Clear Echo</b>	Clears Echo window	SCPI.DISPlay.ECHO.CLEar
<b>Echo Font Size</b>	Sets/reads the font size on Echo window	SCPI.DISPlay.ECHO.FSIZE
<b>Echo Window</b>	Turns on/off the Echo window	SCPI.DISPlay.ECHO.STATE
<b>Load &amp; Run</b>	Load and execute the macro selected on file names.	
<b>Select Macro</b>	Sets/reads the name of the program to be selected	SCPI.PROGram.SELected.NAME
<b>Stop</b>	Set/reads the state of the selected program	SCPI.PROGram.SELected.STATE
<b>User Menu</b>		
<b>User Label 1</b>	Execute the macro assigned under the user defined softkey	SCPI.PROGram.SKEY.ITEM(1-8).IMMediate
<b>User Label 2</b>	Execute the macro assigned under the user defined softkey	SCPI.PROGram.SKEY.ITEM(1-8).IMMediate
<b>User Label 3</b>	Execute the macro assigned under the user defined softkey	SCPI.PROGram.SKEY.ITEM(1-8).IMMediate
<b>User Label 4</b>	Execute the macro assigned under the user defined softkey	SCPI.PROGram.SKEY.ITEM(1-8).IMMediate
<b>User Label 5</b>	Execute the macro assigned under the user defined softkey	SCPI.PROGram.SKEY.ITEM(1-8).IMMediate
<b>User Label 6</b>	Execute the macro assigned under the user defined softkey	SCPI.PROGram.SKEY.ITEM(1-8).IMMediate
<b>User Label 7</b>	Execute the macro assigned under the user defined softkey	SCPI.PROGram.SKEY.ITEM(1-8).IMMediate
<b>User Label 8</b>	Execute the macro assigned under the user defined softkey	SCPI.PROGram.SKEY.ITEM(1-8).IMMediate
<b>VBA Editor Menu</b>		

COM Object Reference  
List by softkey

Front panel key (Operation)	Function	Corresponding COM Object
<b>Close Editor</b>	Close VBA editor	
<b>Load Project</b>	Loads program	SCPI.MMEMory.LOAD.PROGRAM
<b>New Project</b>	Open new VBA project	
<b>Open Editor</b>	Open VBA editor	
<b>Save Project</b>	Save VBA project	SCPI.MMEMory.STORe.PROGRAM
<b>Marker</b>		
<b>Clear Marker Menu</b>		
<b>All OFF</b>	Clears all the markers	
<b>Marker 1</b>	Turns on/off marker 1	SCPI.CALCulate.TR(1-1).TRACe(1-4).MARKer(1-6).STATe
<b>Marker 2</b>	Turns on/off marker 2	SCPI.CALCulate.TR(1-1).TRACe(1-4).MARKer(1-6).STATe
<b>Marker 3</b>	Turns on/off marker 3	SCPI.CALCulate.TR(1-1).TRACe(1-4).MARKer(1-6).STATe
<b>Marker 4</b>	Turns on/off marker 4	SCPI.CALCulate.TR(1-1).TRACe(1-4).MARKer(1-6).STATe
<b>Marker 5</b>	Turns on/off marker 5	SCPI.CALCulate.TR(1-1).TRACe(1-4).MARKer(1-6).STATe
<b>Marker 6</b>	Turns on/off marker 6	SCPI.CALCulate.TR(1-1).TRACe(1-4).MARKer(1-6).STATe
<b>Couple</b>	Turns on/off marker coupling function	SCPI.CALCulate.TR(1-1).ALLTrace.MARKer.COUPle.STATe
<b>Marker 1</b>	Turns on/off marker 1	SCPI.CALCulate.TR(1-1).TRACe(1-4).MARKer(1-6).STATe
<b>Marker 2</b>	Turns on/off marker 2	SCPI.CALCulate.TR(1-1).TRACe(1-4).MARKer(1-6).STATe
<b>Marker 3</b>	Turns on/off marker 3	SCPI.CALCulate.TR(1-1).TRACe(1-4).MARKer(1-6).STATe
<b>Marker 4</b>	Turns on/off marker 4	SCPI.CALCulate.TR(1-1).TRACe(1-4).MARKer(1-6).STATe
<b>Marker 5</b>	Turns on/off marker 5	SCPI.CALCulate.TR(1-1).TRACe(1-4).MARKer(1-6).STATe
<b>Marker 6</b>	Turns on/off marker 6	SCPI.CALCulate.TR(1-1).TRACe(1-4).MARKer(1-6).STATe
<b>Marker List</b>	Turns on/off the marker list	SCPI.DISPLAy.TR(1-1).TABLe.STATe
<b>More Functions</b>		
<b>Discrete</b>	Sets/reads marker movement (Continuous/Discrete)	SCPI.CALCulate.TR(1-1).ALLTrace.MARKer.DISCReTe.STATe

Front panel key (Operation)	Function	Corresponding COM Object
<b>Ref Marker</b>	Sets/reads marker reference number	SCPI.CALCulate.TR(1-1).ALLTrace.MARKer.REFerence.NUMBer
<b>Ref Marker Mode</b>	Turns on/off delta marker mode	SCPI.CALCulate.TR(1-1).ALLTrace.MARKer.REFerence.STATe
<b>Marker Function</b>		
<b>Analysis Range (X)</b>	Sets/reads analysis/search range (X-axis)	SCPI.CALCulate.TR(1-1).TRACe(1-4).FUNCTion.DOMain.X
<b>Analysis Range (Y)</b>	Sets/reads analysis/search range (Y-axis)	SCPI.CALCulate.TR(1-1).TRACe(1-4).FUNCTion.DOMain.Y
<b>Analysis Type</b>	Sets/reads analysis type	SCPI.CALCulate.TR(1-1).TRACe(1-4).FUNCTion.TYPE
<b>Band Marker X</b>		
<b>Band Marker X</b>	Turn on/off bandmarker X	SCPI.CALCulate.TR(1-1).TRACe(1-4).BDMarker.X.STATe
<b>Center</b>	Sets/reads the center value of bandmarker X	SCPI.CALCulate.TR(1-1).TRACe(1-4).BDMarker.X.CENTer
<b>Span</b>	Sets/reads the span value of bandmarker X	SCPI.CALCulate.TR(1-1).TRACe(1-4).BDMarker.X.SPAN
<b>Start</b>	Sets/reads the start value of bandmarker X	SCPI.CALCulate.TR(1-1).TRACe(1-4).BDMarker.X.STARt
<b>Stop</b>	Sets/reads the stop value of bandmarker X	SCPI.CALCulate.TR(1-1).TRACe(1-4).BDMarker.X.STOP
<b>Band Marker Y</b>		
<b>Band Marker Y</b>	Turn on/off bandmarker Y	SCPI.CALCulate.TR(1-1).TRACe(1-4).BDMarker.Y.STATe
<b>Center</b>	Sets/reads the center value of bandmarker Y	SCPI.CALCulate.TR(1-1).TRACe(1-4).BDMarker.Y.CENTer
<b>Span</b>	Sets/reads the span value of bandmarker Y	SCPI.CALCulate.TR(1-1).TRACe(1-4).BDMarker.Y.SPAN
<b>Start</b>	Sets/reads the start value of bandmarker Y	SCPI.CALCulate.TR(1-1).TRACe(1-4).BDMarker.Y.STARt
<b>Stop</b>	Sets/reads the stop value of bandmarker Y	SCPI.CALCulate.TR(1-1).TRACe(1-4).BDMarker.Y.STOP
<b>Couple</b>	Turns on/off bandmarker coupling function	SCPI.CALCulate.TR(1-1).ALLTrace.BDMarker.X.COUPle.STATe
<b>Marker Search</b>		
<b>Band Marker X</b>		
<b>Band Marker X</b>	Turn on/off bandmarker X	SCPI.CALCulate.TR(1-1).TRACe(1-4).BDMarker.X.STATe
<b>Center</b>	Sets/reads the center value of bandmarker X	SCPI.CALCulate.TR(1-1).TRACe(1-4).BDMarker.X.CENTer

COM Object Reference  
List by softkey

Front panel key (Operation)	Function	Corresponding COM Object
<b>Span</b>	Sets/reads the span value of bandmarker X	SCPI.CALCulate.TR(1-1).TRACe(1-4).BDMarker.X.SPAN
<b>Start</b>	Sets/reads the start value of bandmarker X	SCPI.CALCulate.TR(1-1).TRACe(1-4).BDMarker.X.START
<b>Stop</b>	Sets/reads the stop value of bandmarker X	SCPI.CALCulate.TR(1-1).TRACe(1-4).BDMarker.X.STOP
<b>Band Marker Y</b>		
<b>Band Marker Y</b>	Turn on/off bandmarker Y	SCPI.CALCulate.TR(1-1).TRACe(1-4).BDMarker.Y.STATe
<b>Center</b>	Sets/reads the center value of bandmarker Y	SCPI.CALCulate.TR(1-1).TRACe(1-4).BDMarker.Y.CENTer
<b>Span</b>	Sets/reads the span value of bandmarker Y	SCPI.CALCulate.TR(1-1).TRACe(1-4).BDMarker.Y.SPAN
<b>Start</b>	Sets/reads the start value of bandmarker Y	SCPI.CALCulate.TR(1-1).TRACe(1-4).BDMarker.Y.START
<b>Stop</b>	Sets/reads the stop value of bandmarker Y	SCPI.CALCulate.TR(1-1).TRACe(1-4).BDMarker.Y.STOP
<b>Couple</b>	Turns on/off bandmarker coupling function	SCPI.CALCulate.TR(1-1).ALLTrace.BDMarker.X.COUPLe.STATe
<b>Peak</b>		
<b>Peak Excursion</b>	Sets/reads the peak excursion value	SCPI.CALCulate.TR(1-1).TRACe(1-4).MARKer(1-6).SEARch.PEAK.EXCursion
<b>Peak Polarity</b>	Sets/reads the marker peak-search polarity	SCPI.CALCulate.TR(1-1).TRACe(1-4).MARKer(1-6).SEARch.PEAK.POLarity
<b>Search Left</b>	Execute marker peak search left	SCPI.CALCulate.TR(1-1).TRACe(1-4).MARKer(1-6).SEARch.EXECute.LPEak
<b>Search Peak</b>	Execute marker peak search	SCPI.CALCulate.TR(1-1).TRACe(1-4).MARKer(1-6).SEARch.EXECute.PEAK
<b>Search Peak All</b>	Execute marker search all	SCPI.CALCulate.TR(1-1).TRACe(1-4).ALLMarker.SEARch.PEAK
<b>Search Right</b>	Execute marker peak search right	SCPI.CALCulate.TR(1-1).TRACe(1-4).MARKer(1-6).SEARch.EXECute.RPEak
<b>Search Max</b>	Execute marker search maximum	SCPI.CALCulate.TR(1-1).TRACe(1-4).MARKer(1-6).SEARch.EXECute.MAXimum
<b>Search Min</b>	Execute marker search minimum	SCPI.CALCulate.TR(1-1).TRACe(1-4).MARKer(1-6).SEARch.EXECute.MINimum

Front panel key (Operation)	Function	Corresponding COM Object
<b>Search Range (X)</b>	Sets/reads marker search range (X-axis)	SCPI.CALCulate.TR(1-1).TRACe(1-4).ALLMarker.SEARCh.DOMain.X
<b>Search Range (Y)</b>	Sets/reads marker search range (Y-axis)	SCPI.CALCulate.TR(1-1).TRACe(1-4).ALLMarker.SEARCh.DOMain.Y
<b>Target</b>		
<b>Search Left</b>	Execute marker target search left	SCPI.CALCulate.TR(1-1).TRACe(1-4).MARKer(1-6).SEARCh.EXECute.LTARget
<b>Search Right</b>	Execute marker target search right	SCPI.CALCulate.TR(1-1).TRACe(1-4).MARKer(1-6).SEARCh.EXECute.RTARget
<b>Search Target</b>	Execute marker target search	SCPI.CALCulate.TR(1-1).TRACe(1-4).MARKer(1-6).SEARCh.EXECute.TARGet
<b>Target Transition</b>	Sets/reads the target transition definition	SCPI.CALCulate.TR(1-1).TRACe(1-4).MARKer(1-6).SEARCh.TARGet.TRANsition
<b>Target Value</b>	Sets/reads the marker target value	SCPI.CALCulate.TR(1-1).TRACe(1-4).MARKer(1-6).SEARCh.TARGet.Y
<b>Tracking</b>	Sets/reads the marker tracking type	SCPI.CALCulate.TR(1-1).TRACe(1-4).MARKer(1-6).SEARCh.TRACKing.TYPE
<b>Marker To</b>		
<b>Marker -&gt; Phase Reference</b>	Sets phase reference frequency to the marker value in the frequency-over-time trace	SCPI.SENSE.TR(1-1).NARRow.FREQuency.PREFerence
<b>Marker -&gt; Target Freq</b>	Sets target frequency to the marker value in the frequency-over-time trace	SCPI.SENSE.TR(1-1).NARRow.FREQuency.TARGet
<b>Measurement View</b>		
<b>Freq &amp; Power</b>	Selects frequency, power and DC current measurement window	SCPI.DISPlay.WINDow.ACTive
<b>Phase Noise</b>	Selects phase noise measurement window	SCPI.DISPlay.WINDow.ACTive
<b>Show Window</b>		
<b>Freq &amp; Power</b>	Turns on/off frequency, power and DC current measurement mode	SCPI.DISPlay.FP(1-1).STATe
<b>Phase Noise</b>	Turns on/off phase noise measurement mode	SCPI.DISPlay.PN(1-1).STATe
<b>Spectrum Monitor</b>	Turns on/off spectrum monitor mode	SCPI.DISPlay.SP(1-1).STATe
<b>Transient</b>	Turns on/off transient measurement mode	SCPI.DISPlay.TR(1-1).STATe
<b>User</b>	Turns on/off user defined window	SCPI.DISPlay.USER(1-1).STATe
<b>Spectrum Monitor</b>	Selects spectrum monitor mode	SCPI.DISPlay.WINDow.ACTive
<b>Transient</b>	Selects transient measurement mode	SCPI.DISPlay.WINDow.ACTive
<b>User</b>	Selects user defined window	SCPI.DISPlay.WINDow.ACTive

COM Object Reference  
List by softkey

Front panel key (Operation)	Function	Corresponding COM Object
<b>Preset</b>		
<b>Factory</b>	Preset instrument to the initial setup state	SCPI.SYSTem.PRESet
<b>User</b>	Preset instrument and recalls the Autorec.sta in the F drive	
<b>Save/Recall</b>		
<b>Explorer...</b>	Open windows explorer	
<b>Recall by filename</b>	Recalls state file by file name	SCPI.MMEMory.LOAD.STATe
<b>Recall State</b>		
<b>Autorec</b>	Recalls settings	SCPI.MMEMory.LOAD.STATe
<b>File Dialog...</b>	Open file dialog	
<b>State01</b>	Recalls state file from register 1	SCPI.MMEMory.LOAD.STATe
<b>State02</b>	Recalls state file from register 2	SCPI.MMEMory.LOAD.STATe
<b>State03</b>	Recalls state file from register 3	SCPI.MMEMory.LOAD.STATe
<b>State04</b>	Recalls state file from register 4	SCPI.MMEMory.LOAD.STATe
<b>State05</b>	Recalls state file from register 5	SCPI.MMEMory.LOAD.STATe
<b>State06</b>	Recalls state file from register 6	SCPI.MMEMory.LOAD.STATe
<b>Save Data Trace</b>	Saves trace data	SCPI.MMEMory.TR(1-1).TRACe(1-4).STORe.DATA
<b>Save Memory Trace</b>	Saves memory trace data	SCPI.MMEMory.TR(1-1).TRACe(1-4).STORe.MEMory
<b>Save State</b>		
<b>Autorec</b>	Save settings	SCPI.MMEMory.STORe.STATe
<b>File Dialog...</b>	Open file dialog	
<b>Save Type</b>	Selects instrument state type (Entire or instrument state only)	SCPI.MMEMory.STORe.STYPe
<b>State01</b>	Save state file to register 1	SCPI.MMEMory.STORe.STATe
<b>State02</b>	Save state file to register 2	SCPI.MMEMory.STORe.STATe
<b>State03</b>	Save state file to register 3	SCPI.MMEMory.STORe.STATe
<b>State04</b>	Save state file to register 4	SCPI.MMEMory.STORe.STATe
<b>State05</b>	Save state file to register 5	SCPI.MMEMory.STORe.STATe
<b>State06</b>	Save state file to register 6	SCPI.MMEMory.STORe.STATe
<b>Scale</b>		
<b>Auto Scale</b>	Execute autoscale	SCPI.DISPlay.TR(1-1).TRACe(1-4).Y.SCALe.AUTO
<b>Auto Scale All</b>	Execute autoscale for all traces on transient measurement window	SCPI.DISPlay.TR(1-1).ALLTrace.Y.SCALe.AUTO
<b>Divisions</b>	Sets/reads Y-scale divisions	SCPI.DISPlay.TR(1-1).Y.SCALe.DIVisions



Front panel key (Operation)	Function	Corresponding COM Object
<b>Marker -&gt; Reference</b>	Sets the marker value to the reference level	SCPI.DISPlay.TR(1-1).TRACe(1-4).Y.SCALe.RLEVel
<b>Reference Position</b>	Sets/reads reference position	SCPI.DISPlay.TR(1-1).TRACe(1-4).Y.SCALe.RPOSition
<b>Reference Value</b>	Sets/reads reference level value	SCPI.DISPlay.TR(1-1).TRACe(1-4).Y.SCALe.RLEVel
<b>Scale/Div</b>	Sets/reads scale per division	SCPI.DISPlay.TR(1-1).TRACe(1-4).Y.SCALe.PDIVision
<b>Trigger Freq -&gt; Reference</b>	Sets the trigger frequency to the reference level	SCPI.DISPlay.TR(1-1).TRACe(1-4).Y.SCALe.RLEVel
<b>Setup</b>		
<b>Freq Range</b>	Sets/reads frequency transient range (Narrowband)	SCPI.SENSE.TR(1-1).NARRow.FR EQUency.RANGe
<b>Max Input Level</b>	Sets/reads maximum input level	SCPI.SENSE.TR(1-1).POWER.INPut.LEVel.MAXimum
<b>Phase Reference</b>	Sets/reads phase reference frequency	SCPI.SENSE.TR(1-1).NARRow.FR EQUency.PREFeRence
<b>Recalc Phase Reference</b>		
<b>Phase Ref. Offset</b>	Sets/reads the offset value of the phase reference frequency	SCPI.CALCulate.TR(1-1).TRACe(1-4).FORMat.PHASE.PREFeRence.OFFSet
<b>Target Freq</b>	Sets/reads target frequency	SCPI.SENSE.TR(1-1).NARRow.FR EQUency.TARGet
<b>Video Trigger</b>		
<b>Minimum Power Level</b>	Sets/reads video trigger threshold level relative to max input level	SCPI.TRIGger.TR(1-1).NARRow.VIDeo.THREShold
<b>Narrow Freq</b>	Sets/reads video trigger frequency value (Narrowband)	SCPI.TRIGger.TR(1-1).NARRow.VIDeo.FREQUency.CENTer
<b>Wide Freq</b>	Sets/reads video trigger frequency value (Wideband)	SCPI.TRIGger.TR(1-1).WIDE.VIDeo.FREQUency.CENTer
<b>Wide Freq Range</b>	Sets/reads transient frequency range (Wideband)	SCPI.SENSE.TR(1-1).WIDE.FREQUency.MAXimum
<b>Span</b>		
<b>Narrow Ref Position</b>	Sets/reads reference position for time span	SCPI.SENSE.TR(1-1).NARRow.TIME.REFeRence
<b>Narrow Settings -&gt; Wide</b>	Sets narrowband mode settings to wideband mode settings	
<b>Narrow Span</b>	Sets/reads time span (Narrowband)	SCPI.SENSE.TR(1-1).NARRow.TIME.SPAN
<b>Narrow Time Offset</b>	Sets/reads time offset(delay) relative to the reference point	SCPI.SENSE.TR(1-1).NARRow.TIME.OFFSet

COM Object Reference  
List by softkey

Front panel key (Operation)	Function	Corresponding COM Object
<b>Wide Ref Position</b>	Sets/reads reference position	SCPL.SENSE.TR(1-1).WIDE.TIME.REFERENCE
<b>Wide Settings -&gt; Narrow</b>	Sets wideband mode settings to narrowband mode settings	
<b>Wide Span</b>	Sets/reads time span (Wideband)	SCPL.SENSE.TR(1-1).WIDE.TIME.SPAN
<b>Wide Time Offset</b>	Sets/reads time offset(delay) relative to the reference point	SCPL.SENSE.TR(1-1).WIDE.TIME.OFFSet
<b>System</b>		
<b>Abort Printing</b>	Aborts printing	SCPL.HCOPy.ABORt
<b>Backlight</b>	Turns on/off backlight	SCPL.SYSTEm.BACKlight.STATe
<b>Dump Screen Image</b>	Save screen image	SCPL.MMEMory.STORe.IMAGe
<b>Error Log</b>		
<b>Clear Error Log</b>	Clear error log	
<b>View Error Log...</b>	Display error log	
<b>Invert Image</b>	Selects print mode	SCPL.HCOPy.IMAGe
<b>Misc Setup</b>		
<b>Beeper</b>		
<b>Beep Complete</b>	Turns on/off the beep for operation completion	SCPL.SYSTEm.BEEPer.COMPLete.STATe
<b>Beep Warning</b>	Turns on/off the beep for warning	SCPL.SYSTEm.BEEPer.WARNIng.STATe
<b>Test Beep Complete</b>	Makes beep sound for operation completion	SCPL.SYSTEm.BEEPer.COMPLete.IMMediate
<b>Test Beep Warning</b>	Makes beep sound for warning	SCPL.SYSTEm.BEEPer.WARNIng.IMMediate
<b>Clock Setup</b>		
<b>Set Date and Time</b>	Set/reads system time Set/reads system date	SCPL.SYSTEm.TIME[_Q] hour, minute, second SCPL.SYSTEm.DATE[_Q] year, month, day
<b>Show Clock</b>	Turns on/off internal clock display	SCPL.DISPlay.CLOCK
<b>Control Panel ...</b>	Open control panel	
<b> GPIB Setup</b>		
<b>System Controller Configuration</b>	Turns on/off system controller mode	
<b>Talker/Listener Address</b>	Sets the address for controlling the analyzer from a controller via GPIB	

Front panel key (Operation)	Function	Corresponding COM Object
<b>Key Lock</b>		
<b>Front Panel &amp; Keyboard Lock</b>	Disables from panel / keyboard operations	SCPI.SYSTem.KLOCK.KBD
<b>Touch Screen &amp; Mouse Lock</b>	Disables touch screen / mouse operations	SCPI.SYSTem.KLOCK.MOUSe
<b>Network Setup</b>		
<b>MAC Address</b>	Sets MAC address	
<b>Network Configuration</b> ...	Enables/disables network connections	
<b>Network Identification</b> ...	Sets network ID of the instrument	
<b>SICL-LAN Address</b>	Sets SICL-LAN address	
<b>SICL-LAN Server</b>	Enables/disables SICL-LAN server	
<b>Socket Server</b>	Enables/disables Socket server	
<b>Telnet Server</b>	Enables/disables Telnet server	
<b>Print</b>	Outputs print	SCPI.HCOPy.IMMEDIATE
<b>Printer Setup ...</b>	Execute printer setup	
<b>Product Information</b>	Reads product information	
<b>Time Offset</b>		
<b>Narrow Ref Position</b>	Sets/reads reference position for time span (Narrowband mode)	SCPI.SENSE.TR(1-1).NARROW.TIME.REFERENCE
<b>Narrow Settings -&gt; Wide</b>	Sets narrowband mode settings to wideband mode settings	
<b>Narrow Span</b>	Sets/reads time span (Narrowband mode)	SCPI.SENSE.TR(1-1).NARROW.TIME.SPAN
<b>Narrow Time Offset</b>	Sets/reads time offset(delay) relative to the reference point	SCPI.SENSE.TR(1-1).NARROW.TIME.OFFSet
<b>Wide Ref Position</b>	Sets/reads reference position for time span (Wideband mode)	SCPI.SENSE.TR(1-1).WIDE.TIME.REFERENCE
<b>Wide Settings -&gt; Narrow</b>	Sets wideband mode settings to narrowband mode settings	
<b>Wide Span</b>	Sets/reads time span (Wideband mode)	SCPI.SENSE.TR(1-1).WIDE.TIME.SPAN
<b>Wide Time Offset</b>	Sets/reads time offset(delay) relative to the reference point	SCPI.SENSE.TR(1-1).WIDE.TIME.OFFSet
<b>Trace View</b>		

COM Object Reference  
List by softkey

Front panel key (Operation)	Function	Corresponding COM Object
<b>Aperture</b>	Sets/reads smoothing aperture value	SCPI.CALCulate.TR(1-1).TRACe(1-4).SMOothing.APERture
<b>Clear Persistent Data</b>	Clears persistence mode	SCPI.DISPlay.TR(1-1).TRACe(1-4).PERSistence.CLEar
<b>Copy to User</b>	Copies trace data to the user trace	SCPI.CALCulate.TR(1-1).TRACe(1-4).DATA.COPY
<b>Data -&gt; Mem</b>	Copy data to memory	SCPI.CALCulate.TR(1-1).TRACe(1-4).MATH.MEMorize
<b>Data Hold</b>	Selects data hold type	SCPI.CALCulate.TR(1-1).TRACe(1-4).HOLD
<b>Data Math</b>	Sets/reads math operation type	SCPI.CALCulate.TR(1-1).TRACe(1-4).MATH.FUNcTION
<b>Display Trace</b>	Shows data and/or memory trace	SCPI.DISPlay.TR(1-1).TRACe(1-4).MODE
<b>Persistence Mode</b>	Sets/reads persistence mode	SCPI.DISPlay.TR(1-1).TRACe(1-4).PERSistence.STATe
<b>Smoothing</b>	Turns on/off smoothing function	SCPI.CALCulate.TR(1-1).TRACe(1-4).SMOothing.STATe
<b>Trace Label</b>	Edits trace title label	SCPI.DISPlay.TR(1-1).TRACe(1-4).LABel.DATA
<b>Trigger</b>		
<b>Continuous</b>	Sets/reads trigger continuous mode	SCPI.INITiate.TR(1-1).CONTinuous SCPI.INITiate.TR(1-1).IMMediate
<b>Ext Trig Polarity</b>	Sets/reads external trigger polarity	SCPI.TRIGger.EXTernal.SLOPe
<b>Hold</b>	Sets trigger mode to 'HOLD'	SCPI.INITiate.TR(1-1).IMMediate
<b>Manual Trigger</b>	Manual Trigger	SCPI.INITiate.TR(1-1).IMMediate
<b>Restart</b>	Trigger restart	SCPI.INITiate.TR(1-1).IMMediate
<b>Single</b>	Trigger once to the selected measurement mode, then set trigger mode to 'HOLD'	SCPI.INITiate.TR(1-1).CONTinuous SCPI.INITiate.TR(1-1).IMMediate
<b>Source</b>	Selects trigger source	SCPI.TRIGger.TR(1-1).SOURce
<b>Trigger to Transient</b>	Selects measurement mode to be triggered	SCPI.TRIGger.MODE

**USER Menu**

Front panel key (Operation)	Function	Corresponding COM Object
<b>Attenuator</b>		
<b>Input Attenuator</b>	Sets/reads Input Attenuator level on 5dB Step	SCPI.SENSE.ATTenuation.LEVel
<b>DC Control Voltage</b>		
<b>Auto Freq Control</b>		
<b>AFC Status</b>	Turns on/off the auto frequency control function. Executes the auto frequency control once.	SCPI.SOURce.VOLTage.CONTRol.AFC.STATe SCPI.SOURce.VOLTage.CONTRol.AFC.IMMediate
<b>Frequency Band</b>	Sets/reads the frequency band in the auto frequency control function	SCPI.SOURce.VOLTage.CONTRol.AFC.FBANd
<b>Max Ctrl Voltage Limit</b>	Sets/reads the maximum DC control voltage limit	SCPI.SOURce.VOLTage.CONTRol.AFC.LIMit.HIGH
<b>Max Iteration</b>	Sets/reads the maximum number of iterations for the DC control voltage-setting loops	SCPI.SOURce.VOLTage.CONTRol.AFC.ITERation
<b>Min Ctrl Voltage Limit</b>	Sets/reads the minimum DC control voltage limit	SCPI.SOURce.VOLTage.CONTRol.AFC.LIMit.LOW
<b>Sensitivity</b>	Sets/reads the tuning sensitivity	SCPI.SOURce.VOLTage.CONTRol.AFC.SENSitivity
<b>Target</b>	Sets/reads the target frequency in the auto frequency control function	SCPI.SOURce.VOLTage.CONTRol.AFC.TARGet
<b>Tolerance</b>	Sets/reads the tolerance limit	SCPI.SOURce.VOLTage.CONTRol.AFC.TOLerance
<b>Control Voltage Cal</b>	Enables DC Control voltage calibration	SCPI.SOURce.VOLTage.CONTRol.CORRection.STATe
<b>DC Control Delay</b>	Sets/reads DC Control delay (sec)	SCPI.SOURce.VOLTage.CONTRol.DELay
<b>DC Control Output</b>	Turns on/off DC Control voltage	SCPI.SOURce.VOLTage.CONTRol.LEVel.STATe
<b>DC Control Voltage</b>	Sets/reads DC Control voltage	SCPI.SOURce.VOLTage.CONTRol.LEVel.AMPLitude
<b>Execute Control Voltage Cal</b>	Execute DC Control voltage calibration	SCPI.SOURce.VOLTage.CONTRol.CORRection.COLlect.ACQuire
<b>Max Ctrl Voltage Limit</b>	Sets/reads the maximum DC Control voltage limit	SCPI.SOURce.VOLTage.CONTRol.LIMit.HIGH
<b>Min Ctrl Voltage Limit</b>	Sets/reads the minimum DC Control voltage limit	SCPI.SOURce.VOLTage.CONTRol.LIMit.LOW
<b>DC Power Voltage</b>		
<b>DC Power Delay</b>	Sets/reads DC Power delay (sec)	SCPI.SOURce.VOLTage.POWer.DELay

COM Object Reference  
List by softkey

Front panel key (Operation)	Function	Corresponding COM Object
<b>DC Power Output</b>	Turns on/off DC Power voltage	SCPI.SOURce.VOLTage.POWer.LEVel.STATe
<b>DC Power Voltage</b>	Sets/reads DC Power voltage	SCPI.SOURce.VOLTage.POWer.LEVel.AMPLitude
<b>Max Pwr Voltage Limit</b>	Sets/reads the maximum DC Power voltage limit	SCPI.SOURce.VOLTage.POWer.LIMit.HIGH
<b>Min Pwr Voltage Limit</b>	Sets/reads the minimum DC Power voltage limit	SCPI.SOURce.VOLTage.POWer.LIMit.LOW
<b>Display</b>		
<b>Edit Title Label</b>	Edit the measurement window title label	SCPI.DISPlay.USER(1-1).LABel.DATA
<b>Limit Test</b>		
<b>Delete Lower Limit Line</b>	Clears the lower limit line	SCPI.CALCulate.USER(1-1).TRACE(1-8).LIMit.LOWer.SEGMent.CLEAR
<b>Delete Upper Limit Line</b>	Clears the upper limit line	SCPI.CALCulate.USER(1-1).TRACE(1-8).LIMit.UPPer.SEGMent.CLEAR
<b>Explorer</b>		
<b>Fail Sign</b>	Turns on/off the limit test judgement display	SCPI.DISPlay.USER(1-1).LIMit.FSIGN
<b>Import Lower Limit Line ...</b>	Reads the lower limit line	SCPI.MMEMory.USER(1-1).TRACE(1-8).LOAD.LIMit.LOWer
<b>Import Upper Limit Line ...</b>	Reads the upper limit line	SCPI.MMEMory.USER(1-1).TRACE(1-8).LOAD.LIMit.UPPer
<b>Limit Line</b>	Turns on/off the limit line	SCPI.DISPlay.USER(1-1).TRACE(1-8).LIMit.LINE
<b>Limit Test</b>	Turns on/off the limit test function	SCPI.CALCulate.USER(1-1).TRACE(1-8).LIMit.STATe
<b>Marker Information</b>	Sets/reads the marker information position	SCPI.DISPlay.USER(1-1).ANNotation.MARKer.POSition
<b>Meas Condition</b>	Turns on/off measurement conditions	SCPI.DISPlay.USER(1-1).ANNotation.MEASurement.STATe
<b>Relative Y-Scale</b>	Turns on/off relative Y-scale	SCPI.DISPlay.USER(1-1).GRATICule.AXIS.Y.RELative
<b>Title Label</b>	Turns on/off the measurement window title label	SCPI.DISPlay.USER(1-1).LABel.STATe
<b>Update</b>	Turns on/off the trace updates	SCPI.DISPlay.ENABLE
<b>Y # of Digits</b>	Selects the number of digits (Y-axis)	SCPI.DISPlay.USER(1-1).GRATICule.AXIS.Y.STATe
<b>Macro Setup</b>		
<b>E5052 Event</b>	Turns on/off the E5052 VBA event callback function	SCPI.PROGram.COM.EVENT

Front panel key (Operation)	Function	Corresponding COM Object
<b>Echo Window Menu</b>		
<b>Clear Echo</b>	Clears Echo window	SCPI.DISPlay.ECHO.CLEAr
<b>Echo Font Size</b>	Sets/reads the font size on Echo window	SCPI.DISPlay.ECHO.FSIZE
<b>Echo Window</b>	Turn on/off the Echo window	SCPI.DISPlay.ECHO.STATe
<b>Load &amp; Run</b>	Load and execute the macro selected on file names.	
<b>Select Macro</b>	Sets/reads the name of the program to be selected	SCPI.PROGAm.SELected.NAME
<b>Stop</b>	Sets/reads the state of the selected program	SCPI.PROGAm.SELected.STATe
<b>User Menu</b>		
<b>User Label 1</b>	Execute the macro assigned under the user defined softkey	SCPI.PROGAm.SKEY.ITEM(1-8).I MMediate
<b>User Label 2</b>	Execute the macro assigned under the user defined softkey	SCPI.PROGAm.SKEY.ITEM(1-8).I MMediate
<b>User Label 3</b>	Execute the macro assigned under the user defined softkey	SCPI.PROGAm.SKEY.ITEM(1-8).I MMediate
<b>User Label 4</b>	Execute the macro assigned under the user defined softkey	SCPI.PROGAm.SKEY.ITEM(1-8).I MMediate
<b>User Label 5</b>	Execute the macro assigned under the user defined softkey	SCPI.PROGAm.SKEY.ITEM(1-8).I MMediate
<b>User Label 6</b>	Execute the macro assigned under the user defined softkey	SCPI.PROGAm.SKEY.ITEM(1-8).I MMediate
<b>User Label 7</b>	Execute the macro assigned under the user defined softkey	SCPI.PROGAm.SKEY.ITEM(1-8).I MMediate
<b>User Label 8</b>	Execute the macro assigned under the user defined softkey	SCPI.PROGAm.SKEY.ITEM(1-8).I MMediate
<b>VBA Editor Menu</b>		
<b>Close Editor</b>	Close VBA editor	
<b>Load Project</b>	Loads program	SCPI.MMEMory.LOAD.PROGAm
<b>New Project</b>	Open new VBA project	
<b>Open Editor</b>	Open VBA editor	
<b>Save Project</b>	Save VBA project	SCPI.MMEMory.STORe.PROGAm
<b>Marker</b>		
<b>Clear Marker Menu</b>		
<b>All OFF</b>	Clears all the markers	
<b>Marker 1</b>	Turns on/off marker 1	SCPI.CALCulate.USER(1-1).TRAC e(1-8).MARKer(1-6).STATe
<b>Marker 2</b>	Turns on/off marker 2	SCPI.CALCulate.USER(1-1).TRAC e(1-8).MARKer(1-6).STATe

COM Object Reference  
List by softkey

Front panel key (Operation)	Function	Corresponding COM Object
<b>Marker 3</b>	Turns on/off marker 3	SCPI.CALCulate.USER(1-1).TRACe(1-8).MARKer(1-6).STATe
<b>Marker 4</b>	Turns on/off marker 4	SCPI.CALCulate.USER(1-1).TRACe(1-8).MARKer(1-6).STATe
<b>Marker 5</b>	Turns on/off marker 5	SCPI.CALCulate.USER(1-1).TRACe(1-8).MARKer(1-6).STATe
<b>Marker 6</b>	Turns on/off marker 6	SCPI.CALCulate.USER(1-1).TRACe(1-8).MARKer(1-6).STATe
<b>Couple</b>	Turns on/off marker coupling function	SCPI.CALCulate.USER(1-1).ALLTrace.MARKer.COUPle.STATe
<b>Marker 1</b>	Turns on/off marker 1	SCPI.CALCulate.USER(1-1).TRACe(1-8).MARKer(1-6).STATe
<b>Marker 2</b>	Turns on/off marker 2	SCPI.CALCulate.USER(1-1).TRACe(1-8).MARKer(1-6).STATe
<b>Marker 3</b>	Turns on/off marker 3	SCPI.CALCulate.USER(1-1).TRACe(1-8).MARKer(1-6).STATe
<b>Marker 4</b>	Turns on/off marker 4	SCPI.CALCulate.USER(1-1).TRACe(1-8).MARKer(1-6).STATe
<b>Marker 5</b>	Turns on/off marker 5	SCPI.CALCulate.USER(1-1).TRACe(1-8).MARKer(1-6).STATe
<b>Marker 6</b>	Turns on/off marker 6	SCPI.CALCulate.USER(1-1).TRACe(1-8).MARKer(1-6).STATe
<b>Marker List</b>	Turns on/off the marker list	SCPI.DISPlay.USER(1-1).TABLe.STATe
<b>More Functions</b>		
<b>Discrete</b>	Sets/reads marker movement (Continuous/Discrete)	SCPI.CALCulate.USER(1-1).ALLTrace.MARKer.DISCrete.STATe
<b>Ref Marker</b>	Sets/reads marker reference number	SCPI.CALCulate.USER(1-1).ALLTrace.MARKer.REFerence.NUMBer
<b>Ref Marker Mode</b>	Turns on/off delta marker mode	SCPI.CALCulate.USER(1-1).ALLTrace.MARKer.REFerence.STATe
<b>Marker Function</b>		
<b>Analysis Range (X)</b>	Sets/reads analysis/search range (X-axis)	SCPI.CALCulate.USER(1-1).TRACe(1-8).FUNCTion.DOMain.X
<b>Analysis Range (Y)</b>	Sets/reads analysis/search range (Y-axis)	SCPI.CALCulate.USER(1-1).TRACe(1-8).FUNCTion.DOMain.Y
<b>Analysis Type</b>	Sets/reads analysis type	SCPI.CALCulate.USER(1-1).TRACe(1-8).FUNCTion.TYPE
<b>Band Marker X</b>		
<b>Band Marker X</b>	Turns on/off bandmarker X	SCPI.CALCulate.USER(1-1).TRACe(1-8).BDMarker.X.STATe



Front panel key (Operation)	Function	Corresponding COM Object
<b>Center</b>	Sets/reads the center value of bandmarker X	SCPI.CALCulate.USER(1-1).TRACE(1-8).BDMarker.X.CENTer
<b>Span</b>	Sets/reads the span value of bandmarker X	SCPI.CALCulate.USER(1-1).TRACE(1-8).BDMarker.X.SPAN
<b>Start</b>	Sets/reads the start value of bandmarker X	SCPI.CALCulate.USER(1-1).TRACE(1-8).BDMarker.X.STARt
<b>Stop</b>	Sets/reads the stop value of bandmarker X	SCPI.CALCulate.USER(1-1).TRACE(1-8).BDMarker.X.STOP
<b>Band Marker Y</b>		
<b>Band Marker Y</b>	Turns on/off bandmarker Y	SCPI.CALCulate.USER(1-1).TRACE(1-8).BDMarker.Y.STATe
<b>Center</b>	Sets/reads the center value of bandmarker Y	SCPI.CALCulate.USER(1-1).TRACE(1-8).BDMarker.Y.CENTer
<b>Span</b>	Sets/reads the span value of bandmarker Y	SCPI.CALCulate.USER(1-1).TRACE(1-8).BDMarker.Y.SPAN
<b>Start</b>	Sets/reads the start value of bandmarker Y	SCPI.CALCulate.USER(1-1).TRACE(1-8).BDMarker.Y.STARt
<b>Stop</b>	Sets/reads the stop value of bandmarker Y	SCPI.CALCulate.USER(1-1).TRACE(1-8).BDMarker.Y.STOP
<b>Couple</b>	Turns on/off bandmarker coupling function	SCPI.CALCulate.USER(1-1).ALLTrace.BDMarker.X.COUPle.STATe
<b>Marker Search</b>		
<b>Band Marker X</b>		
<b>Band Marker X</b>	Turns on/off bandmarker X	SCPI.CALCulate.USER(1-1).TRACE(1-8).BDMarker.X.STATe
<b>Center</b>	Sets/reads the center value of bandmarker X	SCPI.CALCulate.USER(1-1).TRACE(1-8).BDMarker.X.CENTer
<b>Span</b>	Sets/reads the span value of bandmarker X	SCPI.CALCulate.USER(1-1).TRACE(1-8).BDMarker.X.SPAN
<b>Start</b>	Sets/reads the start value of bandmarker X	SCPI.CALCulate.USER(1-1).TRACE(1-8).BDMarker.X.STARt
<b>Stop</b>	Sets/reads the stop value of bandmarker X	SCPI.CALCulate.USER(1-1).TRACE(1-8).BDMarker.X.STOP
<b>Band Marker Y</b>		
<b>Band Marker Y</b>	Turns on/off bandmarker Y	SCPI.CALCulate.USER(1-1).TRACE(1-8).BDMarker.Y.STATe
<b>Center</b>	Sets/reads the center value of bandmarker Y	SCPI.CALCulate.USER(1-1).TRACE(1-8).BDMarker.Y.CENTer
<b>Span</b>	Sets/reads the span value of bandmarker Y	SCPI.CALCulate.USER(1-1).TRACE(1-8).BDMarker.Y.SPAN
<b>Start</b>	Sets/reads the start value of bandmarker Y	SCPI.CALCulate.USER(1-1).TRACE(1-8).BDMarker.Y.STARt

COM Object Reference  
List by softkey

Front panel key (Operation)	Function	Corresponding COM Object
<b>Stop</b>	Sets/reads the stop value of bandmarker Y	SCPI.CALCulate.USER(1-1).TRACE(1-8).BDMarker.Y.STOP
<b>Couple</b>	Turns on/off bandmarker coupling function	SCPI.CALCulate.USER(1-1).ALLTrace.BDMarker.X.COUPLE.STATE
<b>Peak</b>		
<b>Peak Excursion</b>	Sets/reads the peak excursion value	SCPI.CALCulate.USER(1-1).TRACE(1-8).MARKer(1-6).SEARCH.PEAK.EXCursion
<b>Peak Polarity</b>	Sets/reads the marker peak-search polarity	SCPI.CALCulate.USER(1-1).TRACE(1-8).MARKer(1-6).SEARCH.PEAK.POLarity
<b>Search Left</b>	Execute marker peak search left	SCPI.CALCulate.USER(1-1).TRACE(1-8).MARKer(1-6).SEARCH.EXECute.LPEak
<b>Search Peak</b>	Execute marker peak search	SCPI.CALCulate.USER(1-1).TRACE(1-8).MARKer(1-6).SEARCH.EXECute.PEAK
<b>Search Peak All</b>	Execute marker search all	SCPI.CALCulate.USER(1-1).TRACE(1-8).ALLMarker.SEARCH.PEAK
<b>Search Right</b>	Execute marker peak search right	SCPI.CALCulate.USER(1-1).TRACE(1-8).MARKer(1-6).SEARCH.EXECute.RPEak
<b>Search Max</b>	Execute marker search maximum	SCPI.CALCulate.USER(1-1).TRACE(1-8).MARKer(1-6).SEARCH.EXECute.MAXimum
<b>Search Min</b>	Execute marker search minimum	SCPI.CALCulate.USER(1-1).TRACE(1-8).MARKer(1-6).SEARCH.EXECute.MINimum
<b>Search Range (X)</b>	Sets/reads marker search range (X-axis)	SCPI.CALCulate.USER(1-1).TRACE(1-8).ALLMarker.SEARCH.DOMain.X
<b>Search Range (Y)</b>	Sets/reads marker search range (Y-axis)	SCPI.CALCulate.USER(1-1).TRACE(1-8).ALLMarker.SEARCH.DOMain.Y
<b>Target</b>		
<b>Search Left</b>	Execute marker target search left	SCPI.CALCulate.USER(1-1).TRACE(1-8).MARKer(1-6).SEARCH.EXECute.LTARGET
<b>Search Right</b>	Execute marker target search right	SCPI.CALCulate.USER(1-1).TRACE(1-8).MARKer(1-6).SEARCH.EXECute.RTARGET
<b>Search Target</b>	Execute marker target search	SCPI.CALCulate.USER(1-1).TRACE(1-8).MARKer(1-6).SEARCH.EXECute.TARGET

Front panel key (Operation)	Function	Corresponding COM Object
<b>Target Transition</b>	Sets/reads the target transition definition	SCPI.CALCulate.USER(1-1).TRACE(1-8).MARKer(1-6).SEARCH.TARGET.TRANSition
<b>Target Value</b>	Sets/reads the marker target value	SCPI.CALCulate.USER(1-1).TRACE(1-8).MARKer(1-6).SEARCH.TARGET.Y
<b>Tracking</b>	Sets/reads the marker tracking type	SCPI.CALCulate.USER(1-1).TRACE(1-8).MARKer(1-6).SEARCH.TRACKing.TYPE
<b>Measurement View</b>		
<b>Freq &amp; Power</b>	Selects frequency, power and DC current measurement window	SCPI.DISPlay.WINDow.ACTive
<b>Phase Noise</b>	Selects phase noise measurement window	SCPI.DISPlay.WINDow.ACTive
<b>Show Window</b>		
<b>Freq &amp; Power</b>	Turns on/off frequency, power and DC current measurement mode	SCPI.DISPlay.FP(1-1).STATE
<b>Phase Noise</b>	Turns on/off phase noise measurement mode	SCPI.DISPlay.PN(1-1).STATE
<b>Spectrum Monitor</b>	Turns on/off spectrum monitor mode	SCPI.DISPlay.SP(1-1).STATE
<b>Transient</b>	Turns on/off transient measurement mode	SCPI.DISPlay.TR(1-1).STATE
<b>User</b>	Turns on/off user defined window	SCPI.DISPlay.USER(1-1).STATE
<b>Spectrum Monitor</b>	Selects spectrum monitor mode	SCPI.DISPlay.WINDow.ACTive
<b>Transient</b>	Selects transient measurement mode	SCPI.DISPlay.WINDow.ACTive
<b>User</b>	Selects user defined window	SCPI.DISPlay.WINDow.ACTive
<b>Preset</b>		
<b>Factory</b>	Preset instrument to the initial setup state	SCPI.SYSTem.PRESet
<b>User</b>	Preset instrument and recalls the Autorec.sta in the F drive	
<b>Save/Recall</b>		
<b>Explorer...</b>	Open windows explorer	
<b>Recall by filename</b>	Recalls state file by file name	SCPI.MMEMory.LOAD.STATE
<b>Recall State</b>		
<b>Autorec</b>	Recalls settings	SCPI.MMEMory.LOAD.STATE
<b>File Dialog...</b>	Open file dialog	
<b>State01</b>	Recalls state file from register 1	SCPI.MMEMory.LOAD.STATE
<b>State02</b>	Recalls state file from register 2	SCPI.MMEMory.LOAD.STATE
<b>State03</b>	Recalls state file from register 3	SCPI.MMEMory.LOAD.STATE
<b>State04</b>	Recalls state file from register 4	SCPI.MMEMory.LOAD.STATE
<b>State05</b>	Recalls state file from register 5	SCPI.MMEMory.LOAD.STATE

COM Object Reference  
List by softkey

Front panel key (Operation)	Function	Corresponding COM Object
<b>State06</b>	Recalls state file from register 6	SCPI.MMEMory.LOAD.STATE
<b>Save Data Trace</b>	Saves trace data	SCPI.MMEMory.USER(1-1).TRACe(1-8).STORE.DATA
<b>Save Memory Trace</b>	Saves memory trace data	SCPI.MMEMory.USER(1-1).TRACe(1-8).STORE.MEMory
<b>Save State</b>		
<b>Autorec</b>	Save settings	SCPI.MMEMory.STORE.STATE
<b>File Dialog...</b>	Open file dialog	
<b>Save Type</b>	Selects instrument state type (Entire or instrument state only)	SCPI.MMEMory.STORE.STYPE
<b>State01</b>	Save state file to register 1	SCPI.MMEMory.STORE.STATE
<b>State02</b>	Save state file to register 2	SCPI.MMEMory.STORE.STATE
<b>State03</b>	Save state file to register 3	SCPI.MMEMory.STORE.STATE
<b>State04</b>	Save state file to register 4	SCPI.MMEMory.STORE.STATE
<b>State05</b>	Save state file to register 5	SCPI.MMEMory.STORE.STATE
<b>State06</b>	Save state file to register 6	SCPI.MMEMory.STORE.STATE
<b>Scale</b>		
<b>Auto Scale</b>	Execute autoscale	SCPI.DISPlay.USER(1-1).TRACe(1-8).Y.SCALe.AUTO
<b>Auto Scale All</b>	Execute autoscale for all traces on user defined window	SCPI.DISPlay.USER(1-1).ALLTrace.Y.SCALe.AUTO
<b>Divisions</b>	Sets/reads Y-scale divisions	SCPI.DISPlay.USER(1-1).Y.SCALe.DIVisions
<b>Marker -&gt; Reference</b>	Sets the marker value to the reference level	SCPI.DISPlay.USER(1-1).TRACe(1-8).Y.SCALe.RLEVel
<b>Reference Position</b>	Sets/reads reference position	SCPI.DISPlay.USER(1-1).TRACe(1-8).Y.SCALe.RPOSITION
<b>Reference Value</b>	Sets/reads the reference level value	SCPI.DISPlay.USER(1-1).TRACe(1-8).Y.SCALe.RLEVel
<b>Scale/Div</b>	Sets/reads scale per division	SCPI.DISPlay.USER(1-1).TRACe(1-8).Y.SCALe.PDIVision
<b>X Axis Type</b>	Sets/reads the display type of the x axis.	SCPI.DISPlay.USER(1-1).TRACe(1-8).X.TYPE
<b>X Unit</b>	Sets/reads X-axis unit	SCPI.DISPlay.USER(1-1).TRACe(1-8).X.UNIT
<b>Y Unit</b>	Sets/reads Y-axis unit	SCPI.DISPlay.USER(1-1).TRACe(1-8).Y.UNIT
<b>System</b>		
<b>Abort Printing</b>	Aborts printing	SCPI.HCOPy.ABORt
<b>Backlight</b>	Turns on/off backlight	SCPI.SYSTem.BACKlight.STATE

Front panel key (Operation)	Function	Corresponding COM Object
<b>Dump Screen Image</b>	Save screen image	SCPI.MMEMory.STORe.IMAGe
<b>Error Log</b>		
<b>Clear Error Log</b>	Clear error log	
<b>View Error Log...</b>	Display error log	
<b>Invert Image</b>	Selects print mode	SCPI.HCOPy.IMAGe
<b>Misc Setup</b>		
<b>Beeper</b>		
<b>Beep Complete</b>	Turns on/off the beep for operation completion	SCPI.SYSTem.BEEPer.COMPLete.S TATe
<b>Beep Warning</b>	Turns on/off the beep for warning	SCPI.SYSTem.BEEPer.WARNIng.S TATe
<b>Test Beep Complete</b>	Makes beep sound for operation completion	SCPI.SYSTem.BEEPer.COMPLete.I MMediate
<b>Test Beep Warning</b>	Makes beep sound for warning	SCPI.SYSTem.BEEPer.WARNIng.I MMediate
<b>Clock Setup</b>		
<b>Set Date and Time</b>	Set/reads system time Set/reads system date	SCPI.SYSTem.TIME[_Q] hour, minute, second SCPI.SYSTem.DATE[_Q] year, month, day
<b>Show Clock</b>	Turns on/off internal clock display	SCPI.DISPlay.CLOCK
<b>Control Panel ...</b>	Open control panel	
<b>GPIB Setup</b>		
<b>System Controller Configuration</b>	Turns on/off system controller mode	
<b>Talker/Listener Address</b>	Sets the address for controlling the analyzer from a controller via GPIB	
<b>Key Lock</b>		
<b>Front Panel &amp; Keyboard Lock</b>	Disables from panel / keyboard operations	SCPI.SYSTem.KLOCK.KBD
<b>Touch Screen &amp; Mouse Lock</b>	Disables touch screen / mouse operations	SCPI.SYSTem.KLOCK.MOUSe
<b>Network Setup</b>		
<b>MAC Address</b>	Sets MAC address	
<b>Network Configuration</b>	Enables/disables network connections	

COM Object Reference  
List by softkey

Front panel key (Operation)	Function	Corresponding COM Object
<b>Network Identification</b>	Sets network ID of the instrument	
<b>SICL-LAN Address</b>	Sets SICL-LAN address	
<b>SICL-LAN Server</b>	Enables/disables SICL-LAN server	
<b>Socket Server</b>	Enables/disables Socket server	
<b>Telnet Server</b>	Enables/disables Telnet server	
<b>Print</b>	Outputs print	SCPI.HCOpy.IMMediate
<b>Printer Setup ...</b>	Execute printer setup	
<b>Product Information</b>	Reads product information	
<b>Trace View</b>		
<b>Aperture</b>	Smoothing aperture	SCPI.CALCulate.USER(1-1).TRACe(1-8).SMOothing.APERture
<b>Clear All Persistent Data</b>	clear all persistence mode	SCPI.DISPlay.USER(1-1).ALLTrace.PERSistence.CLEAr
<b>Copy to User</b>	Copies trace data to the user trace	SCPI.CALCulate.USER(1-1).TRACe(1-8).DATA.COpy
<b>Data -&gt; Mem</b>	Copy data to memory	SCPI.CALCulate.USER(1-1).TRACe(1-8).MATH.MEMorize
<b>Data Hold</b>	Data hold	SCPI.CALCulate.USER(1-1).TRACe(1-8).HOLD
<b>Data Math</b>	Sets/reads math operation type	SCPI.CALCulate.USER(1-1).TRACe(1-8).MATH.FUNcTION
<b>Display Trace</b>	Shows data and/or memory trace	SCPI.DISPlay.USER(1-1).TRACe(1-8).MODE
<b>Enable Trace</b>		
<b>Trace 1</b>	Enables/disables data trace 1	SCPI.DISPlay.USER(1-1).TRACe(1-8).STATe
<b>Trace 2</b>	Enables/disables data trace 2	SCPI.DISPlay.USER(1-1).TRACe(1-8).STATe
<b>Trace 3</b>	Enables/disables data trace 3	SCPI.DISPlay.USER(1-1).TRACe(1-8).STATe
<b>Trace 4</b>	Enables/disables data trace 4	SCPI.DISPlay.USER(1-1).TRACe(1-8).STATe
<b>Trace 5</b>	Enables/disables data trace 5	SCPI.DISPlay.USER(1-1).TRACe(1-8).STATe
<b>Trace 6</b>	Enables/disables data trace 6	SCPI.DISPlay.USER(1-1).TRACe(1-8).STATe

Front panel key (Operation)	Function	Corresponding COM Object
<b>Trace 7</b>	Enables/disables data trace 7	SCPI.DISPlay.USER(1-1).TRACe(1-8).STATe
<b>Trace 8</b>	Enables/disables data trace 8	SCPI.DISPlay.USER(1-1).TRACe(1-8).STATe
<b>Persistence Mode</b>	Sets/reads persistence mode	SCPI.DISPlay.USER(1-1).TRACe(1-8).PERStence.STATe
<b>Smoothing</b>	Smoothing on/off	SCPI.CALCulate.USER(1-1).TRACe(1-8).SMOothing.STATe
<b>Trace Label</b>	Edits trace title label	SCPI.DISPlay.USER(1-1).TRACe(1-8).LABel.DATA

COM Object Reference  
**List by softkey**



---

## **A** **Manual Changes**

This appendix contains the information required to adapt this manual to the versions or configurations of the Agilent E5052A which were manufactured earlier than the printing date of this manual.

---

## Manual Changes

The information in this manual applies directly to your Agilent E5052A model that has the applicable firmware version and serial number prefix listed on the title page of this manual. If your model is not listed there, this manual is not applicable to it as is written. To adapt this manual to your E5052A, refer to Table A-1 and Table A-2.

**Table A-1 Manual Changes by Serial Number**

Serial Prefix or Number	Make Manual Changes

**Table A-2 Manual Changes by Firmware Version**

Version	Make Manual Changes
1.10 or later	Change 1
1.50 or later	Change 2

Agilent Technologies uses a two-part, ten-character serial number that is stamped on the serial number plate (Figure A-1). The first five characters are the serial prefix and the last five digits are the suffix.

**Figure A-1 Serial Number Plate (Example)**



e5052apj029

## Change 2

The following functions are integrated newly into the firmware version 1.50 onward. They are not supported by the firmware version 1.10 or earlier.

- Limit test function
- Auto frequency control function
- X-axis divisions
- Selectable preset
- Copy function of measurement result to user window
- Recall function of state file from softkey
- Selectable trace layout in frequency/power measurement mode.
- Integral phase noise, jitter and residual FM measurement in phase noise measurement
- Selectable quality level during phase noise measurement
- Display the progress of phase noise measurement
- Display spurious power value in phase noise measurement
- Moving function of harmonics to the center during spectrum monitor measurement
- Supporting  $\Delta$ Hz,% and ppm data formats in frequency measurement
- Supporting 200kHz frequency range in transient measurement
- Offset adding function to phase reference frequency in transient measurement

## Change 1

The functions listed below are limited when option 011 is installed.

**Table A-3 Limited functions when option 011 is installed**

Functions	Limitations
[PN] Start frequency	Minimum value is 10 Hz
[PN] Correlation	Not Available (The value is fixed as 1)
[PN] IF Gain	Not Available (The value is fixed as 10 dB)
[FP] Trigger Mode	Tester mode only

The SCPI commands that related the limited functions above have also the limitations on the initial values and the range of parameters.

Manual Changes  
**Manual Changes**

**A**

application object, 104  
 autoload.vba, 49

**B**

Boolean, 103  
 boolean type, 103  
 break, 54  
 break point, 59

**C**

character string type, 103  
 class module, 37  
 Clear Echo, 64  
 Close and Return to E5052A, 36  
 Close Editor, 36  
 code window, 38, 42  
 coding, 37  
 COM interface, 94  
 COM object, 31, 100, 102  
 COM OBJECT  
   SCPI.ABORT, 106  
   SCPI.CALCulate.FP(1-1).ALLTrace.ACTive, 106  
   SCPI.CALCulate.FP(1-1).ALLTrace.BDMarker.X.COUPLe.STATe, 106  
   SCPI.CALCulate.FP(1-1).ALLTrace.LIMit.FAIL, 107  
   SCPI.CALCulate.FP(1-1).ALLTrace.MARKer.COUPLe.STATe, 107  
   SCPI.CALCulate.FP(1-1).ALLTrace.MARKer.DISCrete.STATe, 108  
   SCPI.CALCulate.FP(1-1).ALLTrace.MARKer.REFerence.NUMBer, 108  
   SCPI.CALCulate.FP(1-1).ALLTrace.MARKer.REFerence.STATe, 108  
   SCPI.CALCulate.FP(1-1).DATA.RDATa, 109  
   SCPI.CALCulate.FP(1-1).DATA.TDATa, 109  
   SCPI.CALCulate.FP(1-1).DATA.XDATa, 110  
   SCPI.CALCulate.FP(1-1).TRACe(1-4).ALLMarker.ACTive, 110  
   SCPI.CALCulate.FP(1-1).TRACe(1-4).ALLMarker.SEARch.DOMain.X, 110  
   SCPI.CALCulate.FP(1-1).TRACe(1-4).ALLMarker.SEARch.DOMain.Y, 111  
   SCPI.CALCulate.FP(1-1).TRACe(1-4).ALLMarker.SEARch.PEAK, 111  
   SCPI.CALCulate.FP(1-1).TRACe(1-4).BDMarker.X.CENTer, 111  
   SCPI.CALCulate.FP(1-1).TRACe(1-4).BDMarker.X.SPAN, 112  
   SCPI.CALCulate.FP(1-1).TRACe(1-4).BDMarker.X.STARt, 112  
   SCPI.CALCulate.FP(1-1).TRACe(1-4).BDMarker.X.STATe, 112  
   SCPI.CALCulate.FP(1-1).TRACe(1-4).BDMarker.X.STOP, 113

SCPI.CALCulate.FP(1-1).TRACe(1-4).BDMarker.Y.CENTer, 113  
 SCPI.CALCulate.FP(1-1).TRACe(1-4).BDMarker.Y.SPAN, 114  
 SCPI.CALCulate.FP(1-1).TRACe(1-4).BDMarker.Y.STARt, 114  
 SCPI.CALCulate.FP(1-1).TRACe(1-4).BDMarker.Y.STATe, 115  
 SCPI.CALCulate.FP(1-1).TRACe(1-4).BDMarker.Y.STOP, 115  
 SCPI.CALCulate.FP(1-1).TRACe(1-4).DATA.COPY, 115  
 SCPI.CALCulate.FP(1-1).TRACe(1-4).DATA.FDATa, 116  
 SCPI.CALCulate.FP(1-1).TRACe(1-4).DATA.FMEMory, 116  
 SCPI.CALCulate.FP(1-1).TRACe(1-4).DATA.UDATa, 117  
 SCPI.CALCulate.FP(1-1).TRACe(1-4).DATA.UMEMory, 117  
 SCPI.CALCulate.FP(1-1).TRACe(1-4).FORMat.FREQuency, 118  
 SCPI.CALCulate.FP(1-1).TRACe(1-4).FUNCTion.DOMain.X, 118  
 SCPI.CALCulate.FP(1-1).TRACe(1-4).FUNCTion.DOMain.Y, 119  
 SCPI.CALCulate.FP(1-1).TRACe(1-4).FUNCTion.STATistics.DATA\_Q mean, std\_dev, peak\_to\_peak, 119  
 SCPI.CALCulate.FP(1-1).TRACe(1-4).FUNCTion.STATistics.MEMory\_Q mean, std\_dev, peak\_to\_peak, 119  
 SCPI.CALCulate.FP(1-1).TRACe(1-4).FUNCTion.TYPE, 120  
 SCPI.CALCulate.FP(1-1).TRACe(1-4).HOLD, 120  
 SCPI.CALCulate.FP(1-1).TRACe(1-4).LIMit.FAIL, 120  
 SCPI.CALCulate.FP(1-1).TRACe(1-4).LIMit.LOWer.LDATa, 121  
 SCPI.CALCulate.FP(1-1).TRACe(1-4).LIMit.LOWer.SEGMent.CLEAr, 121  
 SCPI.CALCulate.FP(1-1).TRACe(1-4).LIMit.LOWer.SEGMent.COUNT, 121  
 SCPI.CALCulate.FP(1-1).TRACe(1-4).LIMit.LOWer.SEGMent.DATA, 122  
 SCPI.CALCulate.FP(1-1).TRACe(1-4).LIMit.REPort.DATa, 122  
 SCPI.CALCulate.FP(1-1).TRACe(1-4).LIMit.STATe, 122  
 SCPI.CALCulate.FP(1-1).TRACe(1-4).LIMit.UPPer.LDATa, 123  
 SCPI.CALCulate.FP(1-1).TRACe(1-4).LIMit.UPPer.SEGMent.CLEAr, 123  
 SCPI.CALCulate.FP(1-1).TRACe(1-4).LIMit.UPPer.SEGMent.COUNT, 123  
 SCPI.CALCulate.FP(1-1).TRACe(1-4).LIMit.UPPer.SEGMent.DATA, 124  
 SCPI.CALCulate.FP(1-1).TRACe(1-4).MARKer(1-6).SEARch.EXECute.LPEak, 124  
 SCPI.CALCulate.FP(1-1).TRACe(1-4).MARKer(1-6).SEARch.EXECute.LTARget, 124  
 SCPI.CALCulate.FP(1-1).TRACe(1-4).MARKer(1-6).SEARch.EXECute.MAXimum, 125

---

SCPI.CALCulate.FP(1-1).TRACe(1-4).MARKer(1-6).SEARch.EXECute.MINimum, 125  
SCPI.CALCulate.FP(1-1).TRACe(1-4).MARKer(1-6).SEARch.EXECute.PEAK, 125  
SCPI.CALCulate.FP(1-1).TRACe(1-4).MARKer(1-6).SEARch.EXECute.RPEak, 125  
SCPI.CALCulate.FP(1-1).TRACe(1-4).MARKer(1-6).SEARch.EXECute.RTARget, 125  
SCPI.CALCulate.FP(1-1).TRACe(1-4).MARKer(1-6).SEARch.EXECute.TARGet, 126  
SCPI.CALCulate.FP(1-1).TRACe(1-4).MARKer(1-6).SEARch.PEAK.EXCursion, 126  
SCPI.CALCulate.FP(1-1).TRACe(1-4).MARKer(1-6).SEARch.PEAK.POLarity, 126  
SCPI.CALCulate.FP(1-1).TRACe(1-4).MARKer(1-6).SEARch.TARGet.TRANsition, 127  
SCPI.CALCulate.FP(1-1).TRACe(1-4).MARKer(1-6).SEARch.TARGet.Y, 127  
SCPI.CALCulate.FP(1-1).TRACe(1-4).MARKer(1-6).SEARch.TRACKing.TYPE, 128  
SCPI.CALCulate.FP(1-1).TRACe(1-4).MARKer(1-6).STATe, 128  
SCPI.CALCulate.FP(1-1).TRACe(1-4).MARKer(1-6).X, 128  
SCPI.CALCulate.FP(1-1).TRACe(1-4).MARKer(1-6).Y, 129  
SCPI.CALCulate.FP(1-1).TRACe(1-4).MATH.FUNcTion, 129  
SCPI.CALCulate.FP(1-1).TRACe(1-4).MATH.MEMorize, 129  
SCPI.CALCulate.FP(1-1).TRACe(1-4).PARAmeter, 130  
SCPI.CALCulate.FP(1-1).TRACe(1-4).REFerence.FREQuency, 130  
SCPI.CALCulate.FP(1-1).TRACe(1-4).SAPerture, 130  
SCPI.CALCulate.FP(1-1).TRACe(1-4).SMOothing.APERTure, 131  
SCPI.CALCulate.FP(1-1).TRACe(1-4).SMOothing.STATe, 131  
SCPI.CALCulate.PN(1-1).ALLTrace.LIMit.FAIL, 131  
SCPI.CALCulate.PN(1-1).ALLTrace.MARKer.COUPle.STATe, 132  
SCPI.CALCulate.PN(1-1).ALLTrace.MARKer.DISCrete.STATe, 132  
SCPI.CALCulate.PN(1-1).ALLTrace.MARKer.REFerence.NUMBer, 133  
SCPI.CALCulate.PN(1-1).ALLTrace.MARKer.REFerence.STATe, 133  
SCPI.CALCulate.PN(1-1).DATA.CARRier, 133  
SCPI.CALCulate.PN(1-1).DATA.PDATA, 134  
SCPI.CALCulate.PN(1-1).DATA.RDATA, 134  
SCPI.CALCulate.PN(1-1).DATA.XDATA, 135  
SCPI.CALCulate.PN(1-1).TRACe(1-1).ALLMarker.ACTive, 135  
SCPI.CALCulate.PN(1-1).TRACe(1-1).ALLMarker.SEARch.DOMain.X, 135  
SCPI.CALCulate.PN(1-1).TRACe(1-1).ALLMarker.SEARch.DOMain.Y, 136  
SCPI.CALCulate.PN(1-1).TRACe(1-1).ALLMarker.SEARch.PEAK, 136  
SCPI.CALCulate.PN(1-1).TRACe(1-1).BDMarker.X.CENTer, 136  
SCPI.CALCulate.PN(1-1).TRACe(1-1).BDMarker.X.SPAN, 137  
SCPI.CALCulate.PN(1-1).TRACe(1-1).BDMarker.X.STARt, 137  
SCPI.CALCulate.PN(1-1).TRACe(1-1).BDMarker.X.STATe, 138  
SCPI.CALCulate.PN(1-1).TRACe(1-1).BDMarker.X.STOP, 138  
SCPI.CALCulate.PN(1-1).TRACe(1-1).BDMarker.Y.CENTer, 138  
SCPI.CALCulate.PN(1-1).TRACe(1-1).BDMarker.Y.SPAN, 139  
SCPI.CALCulate.PN(1-1).TRACe(1-1).BDMarker.Y.STARt, 139  
SCPI.CALCulate.PN(1-1).TRACe(1-1).BDMarker.Y.STATe, 140  
SCPI.CALCulate.PN(1-1).TRACe(1-1).BDMarker.Y.STOP, 140  
SCPI.CALCulate.PN(1-1).TRACe(1-1).DATA.COPY, 141  
SCPI.CALCulate.PN(1-1).TRACe(1-1).DATA.FDATA, 141  
SCPI.CALCulate.PN(1-1).TRACe(1-1).DATA.FMEMORY, 142  
SCPI.CALCulate.PN(1-1).TRACe(1-1).DATA.PDATA, 142  
SCPI.CALCulate.PN(1-1).TRACe(1-1).DATA.PMEMORY, 143  
SCPI.CALCulate.PN(1-1).TRACe(1-1).DATA.SDATA, 143  
SCPI.CALCulate.PN(1-1).TRACe(1-1).DATA.SMEMORY, 143  
SCPI.CALCulate.PN(1-1).TRACe(1-1).DATA.UDATA, 143  
SCPI.CALCulate.PN(1-1).TRACe(1-1).DATA.UMEMory, 144  
SCPI.CALCulate.PN(1-1).TRACe(1-1).FUNcTion.DOMain.X, 144  
SCPI.CALCulate.PN(1-1).TRACe(1-1).FUNcTion.DOMain.Y, 145  
SCPI.CALCulate.PN(1-1).TRACe(1-1).FUNcTion.INTegrAl.DATA\_Q integ\_noise, freq\_range, rms\_rad, rms\_deg, jitter, residual\_fm, 145  
SCPI.CALCulate.PN(1-1).TRACe(1-1).FUNcTion.INTegrAl.MEMory\_Q integ\_noise, freq\_range, rms\_rad, rms\_deg, jitter, residual\_fm, 145  
SCPI.CALCulate.PN(1-1).TRACe(1-1).FUNcTion.STATistics.DATA\_Q mean, std\_dev, peak\_to\_peak, 145  
SCPI.CALCulate.PN(1-1).TRACe(1-1).FUNcTion.STATistics.MEMory\_Q mean, std\_dev, peak\_to\_peak, 146  
SCPI.CALCulate.PN(1-1).TRACe(1-1).FUNcTion.TYPE, 146  
SCPI.CALCulate.PN(1-1).TRACe(1-1).HOLD, 146  
SCPI.CALCulate.PN(1-1).TRACe(1-1).LIMit.FAIL, 147

- SCPI.CALCulate.PN(1-1).TRACe(1-1).LIMit.LOWer.LD  
ATa, 147
- SCPI.CALCulate.PN(1-1).TRACe(1-1).LIMit.LOWer.SE  
GMent.CLEar, 148
- SCPI.CALCulate.PN(1-1).TRACe(1-1).LIMit.LOWer.SE  
GMent.COUNT, 148
- SCPI.CALCulate.PN(1-1).TRACe(1-1).LIMit.LOWer.SE  
GMent.DATA, 148
- SCPI.CALCulate.PN(1-1).TRACe(1-1).LIMit.REPort.DA  
TA, 149
- SCPI.CALCulate.PN(1-1).TRACe(1-1).LIMit.STATe, 149
- SCPI.CALCulate.PN(1-1).TRACe(1-1).LIMit.UPPer.LDA  
Ta, 149
- SCPI.CALCulate.PN(1-1).TRACe(1-1).LIMit.UPPer.SEG  
Ment.CLEar, 150
- SCPI.CALCulate.PN(1-1).TRACe(1-1).LIMit.UPPer.SEG  
Ment.COUNT, 150
- SCPI.CALCulate.PN(1-1).TRACe(1-1).LIMit.UPPer.SEG  
Ment.DATA, 150
- SCPI.CALCulate.PN(1-1).TRACe(1-1).MARKer(1-6).SE  
ARch.EXECute.LPEak, 151
- SCPI.CALCulate.PN(1-1).TRACe(1-1).MARKer(1-6).SE  
ARch.EXECute.LTARget, 151
- SCPI.CALCulate.PN(1-1).TRACe(1-1).MARKer(1-6).SE  
ARch.EXECute.MAXimum, 151
- SCPI.CALCulate.PN(1-1).TRACe(1-1).MARKer(1-6).SE  
ARch.EXECute.MINimum, 151
- SCPI.CALCulate.PN(1-1).TRACe(1-1).MARKer(1-6).SE  
ARch.EXECute.PEAK, 152
- SCPI.CALCulate.PN(1-1).TRACe(1-1).MARKer(1-6).SE  
ARch.EXECute.RPEak, 152
- SCPI.CALCulate.PN(1-1).TRACe(1-1).MARKer(1-6).SE  
ARch.EXECute.RTARget, 152
- SCPI.CALCulate.PN(1-1).TRACe(1-1).MARKer(1-6).SE  
ARch.EXECute.TARGet, 152
- SCPI.CALCulate.PN(1-1).TRACe(1-1).MARKer(1-6).SE  
ARch.PEAK.EXCursion, 152
- SCPI.CALCulate.PN(1-1).TRACe(1-1).MARKer(1-6).SE  
ARch.PEAK.POLarity, 153
- SCPI.CALCulate.PN(1-1).TRACe(1-1).MARKer(1-6).SE  
ARch.TARGet.TRANsition, 153
- SCPI.CALCulate.PN(1-1).TRACe(1-1).MARKer(1-6).SE  
ARch.TARGet.Y, 154
- SCPI.CALCulate.PN(1-1).TRACe(1-1).MARKer(1-6).SE  
ARch.TRACKing.TYPE, 154
- SCPI.CALCulate.PN(1-1).TRACe(1-1).MARKer(1-6).ST  
ATe, 155
- SCPI.CALCulate.PN(1-1).TRACe(1-1).MARKer(1-6).X,  
155
- SCPI.CALCulate.PN(1-1).TRACe(1-1).MARKer(1-6).Y,  
156
- SCPI.CALCulate.PN(1-1).TRACe(1-1).MATH.FUNcTion,  
156
- SCPI.CALCulate.PN(1-1).TRACe(1-1).MATH.MEMorize  
, 156
- SCPI.CALCulate.PN(1-1).TRACe(1-1).SMOothing.APER  
ture, 156
- SCPI.CALCulate.PN(1-1).TRACe(1-1).SMOothing.STAT  
e, 157
- SCPI.CALCulate.PN(1-1).TRACe(1-1).SPURious.OMISsi  
on, 157
- SCPI.CALCulate.PN(1-1).TRACe(1-1).SPURious.POWer,  
158
- SCPI.CALCulate.PN(1-1).TRACe(1-1).SPURious.THRes  
hold.TABLE.CLEar, 158
- SCPI.CALCulate.PN(1-1).TRACe(1-1).SPURious.THRes  
hold.TABLE.COUNT, 158
- SCPI.CALCulate.PN(1-1).TRACe(1-1).SPURious.THRes  
hold.TABLE.DATA, 159
- SCPI.CALCulate.SP(1-1).ALLTrace.LIMit.FAIL, 159
- SCPI.CALCulate.SP(1-1).ALLTrace.MARKer.COUPle.ST  
ATe, 159
- SCPI.CALCulate.SP(1-1).ALLTrace.MARKer.DISCrete.S  
TATe, 160
- SCPI.CALCulate.SP(1-1).ALLTrace.MARKer.REFerence.  
NUMBer, 160
- SCPI.CALCulate.SP(1-1).ALLTrace.MARKer.REFerence.  
STATe, 161
- SCPI.CALCulate.SP(1-1).DATA.RDATa, 161
- SCPI.CALCulate.SP(1-1).DATA.XDATa, 161
- SCPI.CALCulate.SP(1-1).TRACe(1-1).ALLMarker.ACTi  
ve, 162
- SCPI.CALCulate.SP(1-1).TRACe(1-1).ALLMarker.SEAR  
ch.DOMain.X, 162
- SCPI.CALCulate.SP(1-1).TRACe(1-1).ALLMarker.SEAR  
ch.DOMain.Y, 162
- SCPI.CALCulate.SP(1-1).TRACe(1-1).ALLMarker.SEAR  
ch.PEAK, 163
- SCPI.CALCulate.SP(1-1).TRACe(1-1).BDMarker.X.CEN  
Ter, 163
- SCPI.CALCulate.SP(1-1).TRACe(1-1).BDMarker.X.SPA  
N, 163
- SCPI.CALCulate.SP(1-1).TRACe(1-1).BDMarker.X.STA  
Rt, 164
- SCPI.CALCulate.SP(1-1).TRACe(1-1).BDMarker.X.STAT  
e, 164
- SCPI.CALCulate.SP(1-1).TRACe(1-1).BDMarker.X.STO  
P, 165
- SCPI.CALCulate.SP(1-1).TRACe(1-1).BDMarker.Y.CEN  
Ter, 165
- SCPI.CALCulate.SP(1-1).TRACe(1-1).BDMarker.Y.SPA  
N, 166
- SCPI.CALCulate.SP(1-1).TRACe(1-1).BDMarker.Y.STA  
Rt, 166
- SCPI.CALCulate.SP(1-1).TRACe(1-1).BDMarker.Y.STAT  
e, 167
- SCPI.CALCulate.SP(1-1).TRACe(1-1).BDMarker.Y.STOP  
, 167
- SCPI.CALCulate.SP(1-1).TRACe(1-1).DATA.COPY, 167
- SCPI.CALCulate.SP(1-1).TRACe(1-1).DATA.FDATa, 168
- SCPI.CALCulate.SP(1-1).TRACe(1-1).DATA.FMEMory,  
168
- SCPI.CALCulate.SP(1-1).TRACe(1-1).DATA.UDATa,  
169

---

SCPI.CALCulate.SP(1-1).TRACe(1-1).DATA.UMEMory, 169  
SCPI.CALCulate.SP(1-1).TRACe(1-1).FORMat, 170  
SCPI.CALCulate.SP(1-1).TRACe(1-1).FUNction.DOMain.X, 170  
SCPI.CALCulate.SP(1-1).TRACe(1-1).FUNction.DOMain.Y, 171  
SCPI.CALCulate.SP(1-1).TRACe(1-1).FUNction.STATistics.DATA\_Q mean, std\_dev, peak\_to\_peak, 171  
SCPI.CALCulate.SP(1-1).TRACe(1-1).FUNction.STATistics.MEMory\_Q mean, std\_dev, peak\_to\_peak, 171  
SCPI.CALCulate.SP(1-1).TRACe(1-1).FUNction.TYPE, 172  
SCPI.CALCulate.SP(1-1).TRACe(1-1).HOLD, 172  
SCPI.CALCulate.SP(1-1).TRACe(1-1).LIMit.FAIL, 172  
SCPI.CALCulate.SP(1-1).TRACe(1-1).LIMit.LOWer.LDAta, 173  
SCPI.CALCulate.SP(1-1).TRACe(1-1).LIMit.LOWer.SEGMent.CLEar, 173  
SCPI.CALCulate.SP(1-1).TRACe(1-1).LIMit.LOWer.SEGMent.COUNT, 173  
SCPI.CALCulate.SP(1-1).TRACe(1-1).LIMit.LOWer.SEGMent.DATA, 174  
SCPI.CALCulate.SP(1-1).TRACe(1-1).LIMit.REPort.DATa, 174  
SCPI.CALCulate.SP(1-1).TRACe(1-1).LIMit.STATe, 174  
SCPI.CALCulate.SP(1-1).TRACe(1-1).LIMit.UPPer.LDAta, 175  
SCPI.CALCulate.SP(1-1).TRACe(1-1).LIMit.UPPer.SEGMent.CLEar, 175  
SCPI.CALCulate.SP(1-1).TRACe(1-1).LIMit.UPPer.SEGMent.COUNT, 175  
SCPI.CALCulate.SP(1-1).TRACe(1-1).LIMit.UPPer.SEGMent.DATA, 176  
SCPI.CALCulate.SP(1-1).TRACe(1-1).MARKer(1-6).SEARch.EXECute.LPEak, 176  
SCPI.CALCulate.SP(1-1).TRACe(1-1).MARKer(1-6).SEARch.EXECute.LTARget, 176  
SCPI.CALCulate.SP(1-1).TRACe(1-1).MARKer(1-6).SEARch.EXECute.MAXimum, 177  
SCPI.CALCulate.SP(1-1).TRACe(1-1).MARKer(1-6).SEARch.EXECute.MINimum, 177  
SCPI.CALCulate.SP(1-1).TRACe(1-1).MARKer(1-6).SEARch.EXECute.PEAK, 177  
SCPI.CALCulate.SP(1-1).TRACe(1-1).MARKer(1-6).SEARch.EXECute.RPEak, 177  
SCPI.CALCulate.SP(1-1).TRACe(1-1).MARKer(1-6).SEARch.EXECute.RTARget, 177  
SCPI.CALCulate.SP(1-1).TRACe(1-1).MARKer(1-6).SEARch.EXECute.TARGet, 178  
SCPI.CALCulate.SP(1-1).TRACe(1-1).MARKer(1-6).SEARch.PEAK.EXCursion, 178  
SCPI.CALCulate.SP(1-1).TRACe(1-1).MARKer(1-6).SEARch.PEAK.POLarity, 178  
SCPI.CALCulate.SP(1-1).TRACe(1-1).MARKer(1-6).SEARch.TARGet.TRANsition, 179  
SCPI.CALCulate.SP(1-1).TRACe(1-1).MARKer(1-6).SEARch.TARGet.Y, 179  
SCPI.CALCulate.SP(1-1).TRACe(1-1).MARKer(1-6).SEARch.TRACKing.TYPE, 180  
SCPI.CALCulate.SP(1-1).TRACe(1-1).MARKer(1-6).STATe, 180  
SCPI.CALCulate.SP(1-1).TRACe(1-1).MARKer(1-6).X, 180  
SCPI.CALCulate.SP(1-1).TRACe(1-1).MARKer(1-6).Y, 181  
SCPI.CALCulate.SP(1-1).TRACe(1-1).MATH.FUNction, 181  
SCPI.CALCulate.SP(1-1).TRACe(1-1).MATH.MEMorize, 181  
SCPI.CALCulate.SP(1-1).TRACe(1-1).SMOothing.APERTure, 182  
SCPI.CALCulate.SP(1-1).TRACe(1-1).SMOothing.STATe, 182  
SCPI.CALCulate.TR(1-1).ALLTrace.ACTive, 182  
SCPI.CALCulate.TR(1-1).ALLTrace.BDMarker.X.COUPle.STATe, 183  
SCPI.CALCulate.TR(1-1).ALLTrace.LIMit.FAIL, 183  
SCPI.CALCulate.TR(1-1).ALLTrace.MARKer.COUPle.STATe, 184  
SCPI.CALCulate.TR(1-1).ALLTrace.MARKer.DISCrete.STATe, 184  
SCPI.CALCulate.TR(1-1).ALLTrace.MARKer.REFerence.NUMBer, 184  
SCPI.CALCulate.TR(1-1).ALLTrace.MARKer.REFerence.STATe, 185  
SCPI.CALCulate.TR(1-1).NARRow.DATA.RDATa, 185  
SCPI.CALCulate.TR(1-1).NARRow.DATA.XDATa, 186  
SCPI.CALCulate.TR(1-1).TRACe(1-4).ALLMarker.ACTive, 186  
SCPI.CALCulate.TR(1-1).TRACe(1-4).ALLMarker.SEARch.DOMain.X, 186  
SCPI.CALCulate.TR(1-1).TRACe(1-4).ALLMarker.SEARch.DOMain.Y, 187  
SCPI.CALCulate.TR(1-1).TRACe(1-4).ALLMarker.SEARch.PEAK, 187  
SCPI.CALCulate.TR(1-1).TRACe(1-4).BDMarker.X.CENTer, 187  
SCPI.CALCulate.TR(1-1).TRACe(1-4).BDMarker.X.SPAN, 188  
SCPI.CALCulate.TR(1-1).TRACe(1-4).BDMarker.X.STARt, 188  
SCPI.CALCulate.TR(1-1).TRACe(1-4).BDMarker.X.STATe, 188  
SCPI.CALCulate.TR(1-1).TRACe(1-4).BDMarker.X.STOP, 189  
SCPI.CALCulate.TR(1-1).TRACe(1-4).BDMarker.Y.CENTer, 189  
SCPI.CALCulate.TR(1-1).TRACe(1-4).BDMarker.Y.SPAN, 190  
SCPI.CALCulate.TR(1-1).TRACe(1-4).BDMarker.Y.STARt, 190



- SCPI.CALCulate.TR(1-1).TRACe(1-4).BDMarker.Y.STA  
Te, 191
- SCPI.CALCulate.TR(1-1).TRACe(1-4).BDMarker.Y.STO  
P, 191
- SCPI.CALCulate.TR(1-1).TRACe(1-4).DATA.COPY, 191
- SCPI.CALCulate.TR(1-1).TRACe(1-4).DATA.FDATA,  
192
- SCPI.CALCulate.TR(1-1).TRACe(1-4).DATA.FMEMory,  
192
- SCPI.CALCulate.TR(1-1).TRACe(1-4).DATA.UDATa,  
193
- SCPI.CALCulate.TR(1-1).TRACe(1-4).DATA.UMEMory,  
193
- SCPI.CALCulate.TR(1-1).TRACe(1-4).FORMat.FREQue  
ncy, 194
- SCPI.CALCulate.TR(1-1).TRACe(1-4).FORMat.PHASE.P  
REFerence.OFFSet, 194
- SCPI.CALCulate.TR(1-1).TRACe(1-4).FORMat.PHASE.  
UNIT, 195
- SCPI.CALCulate.TR(1-1).TRACe(1-4).FORMat.PHASE.  
WRAP, 195
- SCPI.CALCulate.TR(1-1).TRACe(1-4).FUNctioN.DOMai  
n.X, 195
- SCPI.CALCulate.TR(1-1).TRACe(1-4).FUNctioN.DOMai  
n.Y, 196
- SCPI.CALCulate.TR(1-1).TRACe(1-4).FUNctioN.STATis  
tics.DATA\_Q mean, std\_dev, peak\_to\_peak, 196
- SCPI.CALCulate.TR(1-1).TRACe(1-4).FUNctioN.STATis  
tics.MEMory\_Q mean, std\_dev, peak\_to\_peak, 196
- SCPI.CALCulate.TR(1-1).TRACe(1-4).FUNctioN.TYPE,  
197
- SCPI.CALCulate.TR(1-1).TRACe(1-4).HOLD, 197
- SCPI.CALCulate.TR(1-1).TRACe(1-4).LIMit.FAIL, 198
- SCPI.CALCulate.TR(1-1).TRACe(1-4).LIMit.LOWer.LD  
ATa, 198
- SCPI.CALCulate.TR(1-1).TRACe(1-4).LIMit.LOWer.SE  
GMent.CLEar, 198
- SCPI.CALCulate.TR(1-1).TRACe(1-4).LIMit.LOWer.SE  
GMent.COUNT, 199
- SCPI.CALCulate.TR(1-1).TRACe(1-4).LIMit.LOWer.SE  
GMent.DATA, 199
- SCPI.CALCulate.TR(1-1).TRACe(1-4).LIMit.REPort.DA  
TA, 199
- SCPI.CALCulate.TR(1-1).TRACe(1-4).LIMit.STATe, 200
- SCPI.CALCulate.TR(1-1).TRACe(1-4).LIMit.UPPer.LDA  
Ta, 200
- SCPI.CALCulate.TR(1-1).TRACe(1-4).LIMit.UPPer.SEG  
Ment.CLEar, 200
- SCPI.CALCulate.TR(1-1).TRACe(1-4).LIMit.UPPer.SEG  
Ment.COUNT, 201
- SCPI.CALCulate.TR(1-1).TRACe(1-4).LIMit.UPPer.SEG  
Ment.DATA, 201
- SCPI.CALCulate.TR(1-1).TRACe(1-4).MARKer(1-6).SE  
ARch.EXECute.LPEak, 201
- SCPI.CALCulate.TR(1-1).TRACe(1-4).MARKer(1-6).SE  
ARch.EXECute.LTARget, 202
- SCPI.CALCulate.TR(1-1).TRACe(1-4).MARKer(1-6).SE  
ARch.EXECute.MAXimum, 202
- SCPI.CALCulate.TR(1-1).TRACe(1-4).MARKer(1-6).SE  
ARch.EXECute.MINimum, 202
- SCPI.CALCulate.TR(1-1).TRACe(1-4).MARKer(1-6).SE  
ARch.EXECute.PEAK, 202
- SCPI.CALCulate.TR(1-1).TRACe(1-4).MARKer(1-6).SE  
ARch.EXECute.RPEak, 202
- SCPI.CALCulate.TR(1-1).TRACe(1-4).MARKer(1-6).SE  
ARch.EXECute.RTARget, 203
- SCPI.CALCulate.TR(1-1).TRACe(1-4).MARKer(1-6).SE  
ARch.EXECute.TARGet, 203
- SCPI.CALCulate.TR(1-1).TRACe(1-4).MARKer(1-6).SE  
ARch.PEAK.EXCursion, 203
- SCPI.CALCulate.TR(1-1).TRACe(1-4).MARKer(1-6).SE  
ARch.PEAK.POLarity, 203
- SCPI.CALCulate.TR(1-1).TRACe(1-4).MARKer(1-6).SE  
ARch.TARGet.TRANsition, 204
- SCPI.CALCulate.TR(1-1).TRACe(1-4).MARKer(1-6).SE  
ARch.TARGet.Y, 204
- SCPI.CALCulate.TR(1-1).TRACe(1-4).MARKer(1-6).SE  
ARch.TRACKing.TYPE, 205
- SCPI.CALCulate.TR(1-1).TRACe(1-4).MARKer(1-6).ST  
ATe, 205
- SCPI.CALCulate.TR(1-1).TRACe(1-4).MARKer(1-6).X,  
206
- SCPI.CALCulate.TR(1-1).TRACe(1-4).MARKer(1-6).Y,  
206
- SCPI.CALCulate.TR(1-1).TRACe(1-4).MATH.FUNctioN,  
206
- SCPI.CALCulate.TR(1-1).TRACe(1-4).MATH.MEMorize  
, 207
- SCPI.CALCulate.TR(1-1).TRACe(1-4).PARAmeter, 207
- SCPI.CALCulate.TR(1-1).TRACe(1-4).REFerence.FREQ  
uency, 207
- SCPI.CALCulate.TR(1-1).TRACe(1-4).SMOothing.APER  
ture, 208
- SCPI.CALCulate.TR(1-1).TRACe(1-4).SMOothing.STAT  
e, 208
- SCPI.CALCulate.TR(1-1).WIDE.DATA.RDATa, 208
- SCPI.CALCulate.TR(1-1).WIDE.DATA.XDATa, 209
- SCPI.CALCulate.USER(1-1).ALLTrace.ACTive, 209
- SCPI.CALCulate.USER(1-1).ALLTrace.BDMarker.X.CO  
Uple.STATe, 209
- SCPI.CALCulate.USER(1-1).ALLTrace.LIMit.FAIL, 210
- SCPI.CALCulate.USER(1-1).ALLTrace.MARKer.COUPLE  
.STATe, 210
- SCPI.CALCulate.USER(1-1).ALLTrace.MARKer.DISCRet  
e.STATe, 211
- SCPI.CALCulate.USER(1-1).ALLTrace.MARKer.REFere  
nce.NUMBer, 211
- SCPI.CALCulate.USER(1-1).ALLTrace.MARKer.REFere  
nce.STATe, 211
- SCPI.CALCulate.USER(1-1).TRACe(1-8).ALLMarker.A  
CTive, 212
- SCPI.CALCulate.USER(1-1).TRACe(1-8).ALLMarker.SE  
ARch.DOMain.X, 212

---

SCPI.CALCulate.USER(1-1).TRACe(1-8).ALLMarker.SEARch.DOMain.Y, 213  
SCPI.CALCulate.USER(1-1).TRACe(1-8).ALLMarker.SEARch.PEAK, 213  
SCPI.CALCulate.USER(1-1).TRACe(1-8).BDMarker.XCENTer, 213  
SCPI.CALCulate.USER(1-1).TRACe(1-8).BDMarker.XSPAN, 214  
SCPI.CALCulate.USER(1-1).TRACe(1-8).BDMarker.XSTART, 214  
SCPI.CALCulate.USER(1-1).TRACe(1-8).BDMarker.XSTATe, 215  
SCPI.CALCulate.USER(1-1).TRACe(1-8).BDMarker.XSTOP, 215  
SCPI.CALCulate.USER(1-1).TRACe(1-8).BDMarker.YCENTer, 216  
SCPI.CALCulate.USER(1-1).TRACe(1-8).BDMarker.YSPAN, 216  
SCPI.CALCulate.USER(1-1).TRACe(1-8).BDMarker.YSTART, 217  
SCPI.CALCulate.USER(1-1).TRACe(1-8).BDMarker.YSTATe, 217  
SCPI.CALCulate.USER(1-1).TRACe(1-8).BDMarker.YSTOP, 217  
SCPI.CALCulate.USER(1-1).TRACe(1-8).DATA.COPY, 218  
SCPI.CALCulate.USER(1-1).TRACe(1-8).DATA.FDATA, 218  
SCPI.CALCulate.USER(1-1).TRACe(1-8).DATA.FMEMORY, 219  
SCPI.CALCulate.USER(1-1).TRACe(1-8).DATA.POINTs, 219  
SCPI.CALCulate.USER(1-1).TRACe(1-8).DATA.RDATA, 219  
SCPI.CALCulate.USER(1-1).TRACe(1-8).DATA.START, 220  
SCPI.CALCulate.USER(1-1).TRACe(1-8).DATA.STOP, 220  
SCPI.CALCulate.USER(1-1).TRACe(1-8).DATA.UDATA, 220  
SCPI.CALCulate.USER(1-1).TRACe(1-8).DATA.UMEMory, 221  
SCPI.CALCulate.USER(1-1).TRACe(1-8).DATA.XDATA, 221  
SCPI.CALCulate.USER(1-1).TRACe(1-8).FUNCTION.DOMain.X, 221  
SCPI.CALCulate.USER(1-1).TRACe(1-8).FUNCTION.DOMain.Y, 222  
SCPI.CALCulate.USER(1-1).TRACe(1-8).FUNCTION.STATistics.DATA\_Q mean, std\_dev, peak\_to\_peak, 222  
SCPI.CALCulate.USER(1-1).TRACe(1-8).FUNCTION.STATistics.MEMory\_Q mean, std\_dev, peak\_to\_peak, 223  
SCPI.CALCulate.USER(1-1).TRACe(1-8).FUNCTION.TYPE, 223  
SCPI.CALCulate.USER(1-1).TRACe(1-8).HOLD, 223  
SCPI.CALCulate.USER(1-1).TRACe(1-8).LIMit.FAIL, 224  
SCPI.CALCulate.USER(1-1).TRACe(1-8).LIMit.LOWER.LDATA, 224  
SCPI.CALCulate.USER(1-1).TRACe(1-8).LIMit.LOWER.SEGMent.CLEAR, 224  
SCPI.CALCulate.USER(1-1).TRACe(1-8).LIMit.LOWER.SEGMent.COUNT, 225  
SCPI.CALCulate.USER(1-1).TRACe(1-8).LIMit.LOWER.SEGMent.DATA, 225  
SCPI.CALCulate.USER(1-1).TRACe(1-8).LIMit.REPORT.DATA, 225  
SCPI.CALCulate.USER(1-1).TRACe(1-8).LIMit.STATe, 226  
SCPI.CALCulate.USER(1-1).TRACe(1-8).LIMit.UPPER.LDATA, 226  
SCPI.CALCulate.USER(1-1).TRACe(1-8).LIMit.UPPER.SEGMent.CLEAR, 226  
SCPI.CALCulate.USER(1-1).TRACe(1-8).LIMit.UPPER.SEGMent.COUNT, 227  
SCPI.CALCulate.USER(1-1).TRACe(1-8).LIMit.UPPER.SEGMent.DATA, 227  
SCPI.CALCulate.USER(1-1).TRACe(1-8).MARKer(1-6).SEARch.EXECute.LPEak, 227  
SCPI.CALCulate.USER(1-1).TRACe(1-8).MARKer(1-6).SEARch.EXECute.LTARget, 228  
SCPI.CALCulate.USER(1-1).TRACe(1-8).MARKer(1-6).SEARch.EXECute.MAXimum, 228  
SCPI.CALCulate.USER(1-1).TRACe(1-8).MARKer(1-6).SEARch.EXECute.MINimum, 228  
SCPI.CALCulate.USER(1-1).TRACe(1-8).MARKer(1-6).SEARch.EXECute.PEAK, 228  
SCPI.CALCulate.USER(1-1).TRACe(1-8).MARKer(1-6).SEARch.EXECute.RPEak, 228  
SCPI.CALCulate.USER(1-1).TRACe(1-8).MARKer(1-6).SEARch.EXECute.RTARget, 229  
SCPI.CALCulate.USER(1-1).TRACe(1-8).MARKer(1-6).SEARch.EXECute.TARGet, 229  
SCPI.CALCulate.USER(1-1).TRACe(1-8).MARKer(1-6).SEARch.PEAK.EXCursion, 229  
SCPI.CALCulate.USER(1-1).TRACe(1-8).MARKer(1-6).SEARch.PEAK.POLarity, 229  
SCPI.CALCulate.USER(1-1).TRACe(1-8).MARKer(1-6).SEARch.TARGet.TRANSition, 230  
SCPI.CALCulate.USER(1-1).TRACe(1-8).MARKer(1-6).SEARch.TARGet.Y, 230  
SCPI.CALCulate.USER(1-1).TRACe(1-8).MARKer(1-6).SEARch.TRACKing.TYPE, 231  
SCPI.CALCulate.USER(1-1).TRACe(1-8).MARKer(1-6).STATe, 231  
SCPI.CALCulate.USER(1-1).TRACe(1-8).MARKer(1-6).X, 232  
SCPI.CALCulate.USER(1-1).TRACe(1-8).MARKer(1-6).Y, 232  
SCPI.CALCulate.USER(1-1).TRACe(1-8).MATH.FUNCTion, 232  
SCPI.CALCulate.USER(1-1).TRACe(1-8).MATH.MEMorize, 233

- SCPI.CALCulate.USER(1-1).TRACe(1-8).SMOothing.AP  
ERture, 233
- SCPI.CALCulate.USER(1-1).TRACe(1-8).SMOothing.ST  
ATe, 234
- SCPI.CONTRol.HANDler.A.DATA, 234
- SCPI.CONTRol.HANDler.B.DATA, 234
- SCPI.CONTRol.HANDler.C.DATA, 235
- SCPI.CONTRol.HANDler.C.MODE, 235
- SCPI.CONTRol.HANDler.D.DATA, 236
- SCPI.CONTRol.HANDler.D.MODE, 236
- SCPI.CONTRol.HANDler.E.DATA, 236
- SCPI.CONTRol.HANDler.F.DATA, 237
- SCPI.CONTRol.HANDler.OUTPut(1-2).DATA, 237
- SCPI.DISPlay.CLOCK, 238
- SCPI.DISPlay.ECHO.ADD, 238
- SCPI.DISPlay.ECHO.CLEAr, 238
- SCPI.DISPlay.ECHO.DATA, 239
- SCPI.DISPlay.ECHO.FSIZe, 239
- SCPI.DISPlay.ECHO.STATe, 240
- SCPI.DISPlay.ENABLE, 240
- SCPI.DISPlay.FP(1-1).ALLTrace.PERSistence.CLEAr, 241
- SCPI.DISPlay.FP(1-1).ALLTrace.Y.SCALe.AUTO, 241
- SCPI.DISPlay.FP(1-1).ANNotation.MARKer.POSition,  
241
- SCPI.DISPlay.FP(1-1).ANNotation.MEASurement.STATe,  
241
- SCPI.DISPlay.FP(1-1).GRATicule.AXIS.Y.RELative, 242
- SCPI.DISPlay.FP(1-1).GRATicule.AXIS.Y.STATe, 242
- SCPI.DISPlay.FP(1-1).LABel.DATA, 242
- SCPI.DISPlay.FP(1-1).LABel.STATe, 243
- SCPI.DISPlay.FP(1-1).LIMit.FSIGn, 243
- SCPI.DISPlay.FP(1-1).MAXimize, 244
- SCPI.DISPlay.FP(1-1).SPLit, 244
- SCPI.DISPlay.FP(1-1).STATe, 244
- SCPI.DISPlay.FP(1-1).TABLe.STATe, 245
- SCPI.DISPlay.FP(1-1).TRACe(1-4).LABel.DATA, 245
- SCPI.DISPlay.FP(1-1).TRACe(1-4).LIMit.LINE, 246
- SCPI.DISPlay.FP(1-1).TRACe(1-4).MODE, 246
- SCPI.DISPlay.FP(1-1).TRACe(1-4).PERSistence.CLEAr,  
246
- SCPI.DISPlay.FP(1-1).TRACe(1-4).PERSistence.STATe,  
247
- SCPI.DISPlay.FP(1-1).TRACe(1-4).Y.SCALe.AUTO, 247
- SCPI.DISPlay.FP(1-1).TRACe(1-4).Y.SCALe.PDIVision,  
247
- SCPI.DISPlay.FP(1-1).TRACe(1-4).Y.SCALe.RLEVel,  
247
- SCPI.DISPlay.FP(1-1).TRACe(1-4).Y.SCALe.RPOSITION,  
248
- SCPI.DISPlay.FP(1-1).Y.SCALe.DIVisions, 248
- SCPI.DISPlay.MAXimize, 249
- SCPI.DISPlay.MESSage.CLEAr, 249
- SCPI.DISPlay.PN(1-1).ALLTrace.PERSistence.CLEAr,  
249
- SCPI.DISPlay.PN(1-1).ANNotation.MARKer.POSition,  
250
- SCPI.DISPlay.PN(1-1).ANNotation.MEASurement.STATe  
, 250
- SCPI.DISPlay.PN(1-1).GRATicule.AXIS.Y.RELative, 250
- SCPI.DISPlay.PN(1-1).GRATicule.AXIS.Y.STATe, 251
- SCPI.DISPlay.PN(1-1).LABel.DATA, 251
- SCPI.DISPlay.PN(1-1).LABel.STATe, 252
- SCPI.DISPlay.PN(1-1).LIMit.FSIGn, 252
- SCPI.DISPlay.PN(1-1).MAXimize, 252
- SCPI.DISPlay.PN(1-1).STATe, 253
- SCPI.DISPlay.PN(1-1).TABLe.STATe, 253
- SCPI.DISPlay.PN(1-1).TRACe(1-1).LABel.DATA, 254
- SCPI.DISPlay.PN(1-1).TRACe(1-1).LIMit.LINE, 254
- SCPI.DISPlay.PN(1-1).TRACe(1-1).MODE, 254
- SCPI.DISPlay.PN(1-1).TRACe(1-1).PERSistence.CLEAr,  
255
- SCPI.DISPlay.PN(1-1).TRACe(1-1).PERSistence.STATe,  
255
- SCPI.DISPlay.PN(1-1).TRACe(1-1).Y.SCALe.AUTO, 255
- SCPI.DISPlay.PN(1-1).TRACe(1-1).Y.SCALe.PDIVision,  
256
- SCPI.DISPlay.PN(1-1).TRACe(1-1).Y.SCALe.RLEVel,  
256
- SCPI.DISPlay.PN(1-1).TRACe(1-1).Y.SCALe.RPOSITION,  
256
- SCPI.DISPlay.PN(1-1).Y.SCALe.DIVisions, 257
- SCPI.DISPlay.SKEY.STATe, 257
- SCPI.DISPlay.SP(1-1).ALLTrace.PERSistence.CLEAr, 258
- SCPI.DISPlay.SP(1-1).ANNotation.MARKer.POSition,  
258
- SCPI.DISPlay.SP(1-1).ANNotation.MEASurement.STATe,  
258
- SCPI.DISPlay.SP(1-1).GRATicule.AXIS.Y.RELative, 258
- SCPI.DISPlay.SP(1-1).GRATicule.AXIS.Y.STATe, 259
- SCPI.DISPlay.SP(1-1).LABel.DATA, 259
- SCPI.DISPlay.SP(1-1).LABel.STATe, 260
- SCPI.DISPlay.SP(1-1).LIMit.FSIGn, 260
- SCPI.DISPlay.SP(1-1).MAXimize, 260
- SCPI.DISPlay.SP(1-1).STATe, 261
- SCPI.DISPlay.SP(1-1).TABLe.STATe, 261
- SCPI.DISPlay.SP(1-1).TRACe(1-1).LABel.DATA, 262
- SCPI.DISPlay.SP(1-1).TRACe(1-1).LIMit.LINE, 262
- SCPI.DISPlay.SP(1-1).TRACe(1-1).MODE, 262
- SCPI.DISPlay.SP(1-1).TRACe(1-1).PERSistence.CLEAr,  
263
- SCPI.DISPlay.SP(1-1).TRACe(1-1).PERSistence.STATe,  
263
- SCPI.DISPlay.SP(1-1).TRACe(1-1).Y.SCALe.AUTO, 263
- SCPI.DISPlay.SP(1-1).TRACe(1-1).Y.SCALe.PDIVision,  
264
- SCPI.DISPlay.SP(1-1).TRACe(1-1).Y.SCALe.RLEVel,  
264
- SCPI.DISPlay.SP(1-1).TRACe(1-1).Y.SCALe.RPOSITION,  
264
- SCPI.DISPlay.SP(1-1).Y.SCALe.DIVisions, 265
- SCPI.DISPlay.TR(1-1).ALLTrace.PERSistence.CLEAr,  
265
- SCPI.DISPlay.TR(1-1).ALLTrace.Y.SCALe.AUTO, 265

- SCPI.DISPlay.TR(1-1).ANNOtation.MARKer.POSition, 266
- SCPI.DISPlay.TR(1-1).ANNOtation.MEASurement.STATe, 266
- SCPI.DISPlay.TR(1-1).GRATicule.AXIS.Y.RELative, 266
- SCPI.DISPlay.TR(1-1).GRATicule.AXIS.Y.STATe, 267
- SCPI.DISPlay.TR(1-1).LABel.DATA, 267
- SCPI.DISPlay.TR(1-1).LABel.STATe, 268
- SCPI.DISPlay.TR(1-1).LIMit.FSIGN, 268
- SCPI.DISPlay.TR(1-1).MAXimize, 268
- SCPI.DISPlay.TR(1-1).STATe, 269
- SCPI.DISPlay.TR(1-1).TABLe.STATe, 269
- SCPI.DISPlay.TR(1-1).TRACe(1-4).LABel.DATA, 270
- SCPI.DISPlay.TR(1-1).TRACe(1-4).LIMit.LINE, 270
- SCPI.DISPlay.TR(1-1).TRACe(1-4).MODE, 270
- SCPI.DISPlay.TR(1-1).TRACe(1-4).PERSistence.CLEAr, 271
- SCPI.DISPlay.TR(1-1).TRACe(1-4).PERSistence.STATe, 271
- SCPI.DISPlay.TR(1-1).TRACe(1-4).Y.SCALe.AUTO, 271
- SCPI.DISPlay.TR(1-1).TRACe(1-4).Y.SCALe.PDIVision, 272
- SCPI.DISPlay.TR(1-1).TRACe(1-4).Y.SCALe.RLEVel, 272
- SCPI.DISPlay.TR(1-1).TRACe(1-4).Y.SCALe.RPOSITION, 272
- SCPI.DISPlay.TR(1-1).Y.SCALe.DIVisions, 273
- SCPI.DISPlay.UPDate.IMMEDIATE, 273
- SCPI.DISPlay.USER(1-1).ALLTrace.PERSistence.CLEAr, 273
- SCPI.DISPlay.USER(1-1).ALLTrace.Y.SCALe.AUTO, 274
- SCPI.DISPlay.USER(1-1).ANNOtation.MARKer.POSition, 274
- SCPI.DISPlay.USER(1-1).ANNOtation.MEASurement.STATe, 274
- SCPI.DISPlay.USER(1-1).GRATicule.AXIS.Y.RELative, 274
- SCPI.DISPlay.USER(1-1).GRATicule.AXIS.Y.STATe, 275
- SCPI.DISPlay.USER(1-1).LABel.DATA, 275
- SCPI.DISPlay.USER(1-1).LABel.STATe, 276
- SCPI.DISPlay.USER(1-1).LIMit.FSIGN, 276
- SCPI.DISPlay.USER(1-1).MAXimize, 276
- SCPI.DISPlay.USER(1-1).STATe, 277
- SCPI.DISPlay.USER(1-1).TABLe.STATe, 277
- SCPI.DISPlay.USER(1-1).TRACe(1-8).LABel.DATA, 278
- SCPI.DISPlay.USER(1-1).TRACe(1-8).LIMit.LINE, 278
- SCPI.DISPlay.USER(1-1).TRACe(1-8).MODE, 278
- SCPI.DISPlay.USER(1-1).TRACe(1-8).PERSistence.STATe, 279
- SCPI.DISPlay.USER(1-1).TRACe(1-8).STATe, 279
- SCPI.DISPlay.USER(1-1).TRACe(1-8).X.TYPE, 280
- SCPI.DISPlay.USER(1-1).TRACe(1-8).X.UNIT, 280
- SCPI.DISPlay.USER(1-1).TRACe(1-8).Y.SCALe.AUTO, 280
- SCPI.DISPlay.USER(1-1).TRACe(1-8).Y.SCALe.PDIVision, 280
- SCPI.DISPlay.USER(1-1).TRACe(1-8).Y.SCALe.RLEVel, 281
- SCPI.DISPlay.USER(1-1).TRACe(1-8).Y.SCALe.RPOSITION, 281
- SCPI.DISPlay.USER(1-1).TRACe(1-8).Y.UNIT, 282
- SCPI.DISPlay.USER(1-1).Y.SCALe.DIVisions, 282
- SCPI.DISPlay.WINDOW.ACTive, 283
- SCPI.FORMat.BORDER, 283
- SCPI.FORMat.DATA, 284
- SCPI.HCOPy.ABORt, 284
- SCPI.HCOPy.IMAGe, 284
- SCPI.HCOPy.IMMEDIATE, 285
- SCPI.IEEE4882.CLS, 285
- SCPI.IEEE4882.ESE, 285
- SCPI.IEEE4882.ESR, 286
- SCPI.IEEE4882.IDN, 286
- SCPI.IEEE4882.OPC, 286
- SCPI.IEEE4882.OPT, 286
- SCPI.IEEE4882.RST, 287
- SCPI.IEEE4882.SRE, 287
- SCPI.IEEE4882.STB, 287
- SCPI.IEEE4882.TRG, 287
- SCPI.INITiate.FP(1-1).CONTInuous, 287
- SCPI.INITiate.FP(1-1).IMMEDIATE, 288
- SCPI.INITiate.PN(1-1).CONTInuous, 288
- SCPI.INITiate.PN(1-1).IMMEDIATE, 288
- SCPI.INITiate.SP(1-1).CONTInuous, 288
- SCPI.INITiate.SP(1-1).IMMEDIATE, 289
- SCPI.INITiate.TR(1-1).CONTInuous, 289
- SCPI.INITiate.TR(1-1).IMMEDIATE, 289
- SCPI.MMEMory.CATalog\_Q dir, list, 290
- SCPI.MMEMory.COPY src, dst, 290
- SCPI.MMEMory.DATA[\_Q] file, data, 290
- SCPI.MMEMory.DELete, 291
- SCPI.MMEMory.FP(1-1).TRACe(1-4).LOAD.LIMit.LOWER, 291
- SCPI.MMEMory.FP(1-1).TRACe(1-4).LOAD.LIMit.UPPER, 292
- SCPI.MMEMory.FP(1-1).TRACe(1-4).STORE.DATA, 292
- SCPI.MMEMory.FP(1-1).TRACe(1-4).STORE.MEMory, 293
- SCPI.MMEMory.LOAD.PROGRAM, 293
- SCPI.MMEMory.LOAD.STATe, 293
- SCPI.MMEMory.MDIRectory, 294
- SCPI.MMEMory.PN(1-1).TRACe(1-1).LOAD.LIMit.LOWER, 294
- SCPI.MMEMory.PN(1-1).TRACe(1-1).LOAD.LIMit.UPPER, 295
- SCPI.MMEMory.PN(1-1).TRACe(1-1).LOAD.SPURious.THReshold, 295
- SCPI.MMEMory.PN(1-1).TRACe(1-1).STORE.DATA, 295
- SCPI.MMEMory.PN(1-1).TRACe(1-1).STORE.MEMory, 296
- SCPI.MMEMory.SP(1-1).TRACe(1-1).LOAD.LIMit.LOWER, 296

- SCPI.MMEMory.SP(1-1).TRACe(1-1).LOAD.LIMit.UPPer, 297  
 SCPI.MMEMory.SP(1-1).TRACe(1-1).STORE.DATA, 297  
 SCPI.MMEMory.SP(1-1).TRACe(1-1).STORE.MEMory, 297  
 SCPI.MMEMory.STORE.IMAGe, 298  
 SCPI.MMEMory.STORE.PROGram, 298  
 SCPI.MMEMory.STORE.STATe, 299  
 SCPI.MMEMory.STORE.STYPE, 299  
 SCPI.MMEMory.TR(1-1).TRACe(1-4).LOAD.LIMit.LOWer, 299  
 SCPI.MMEMory.TR(1-1).TRACe(1-4).LOAD.LIMit.UPPer, 300  
 SCPI.MMEMory.TR(1-1).TRACe(1-4).STORE.DATA, 300  
 SCPI.MMEMory.TR(1-1).TRACe(1-4).STORE.MEMory, 301  
 SCPI.MMEMory.USER(1-1).TRACe(1-8).LOAD.LIMit.LOWer, 301  
 SCPI.MMEMory.USER(1-1).TRACe(1-8).LOAD.LIMit.UPPer, 301  
 SCPI.MMEMory.USER(1-1).TRACe(1-8).STORE.DATA, 302  
 SCPI.MMEMory.USER(1-1).TRACe(1-8).STORE.MEMory, 302  
 SCPI.PROGram.CATalog, 303  
 SCPI.PROGram.COM.EVENT, 303  
 SCPI.PROGram.SELected.NAME, 303  
 SCPI.PROGram.SELected.STATe, 304  
 SCPI.PROGram.SKEY.ITEM(1-8).ENABLE, 304  
 SCPI.PROGram.SKEY.ITEM(1-8).IMMediate, 304  
 SCPI.PROGram.SKEY.ITEM(1-8).LABel, 305  
 SCPI.PROGram.VARiable.ARRay(1-10).DATA, 305  
 SCPI.PROGram.VARiable.ARRay(1-10).POINts, 305  
 SCPI.PROGram.VARiable.DOUBle(1-10), 306  
 SCPI.PROGram.VARiable.INTeger(1-10), 306  
 SCPI.PROGram.VARiable.STRing(1-10), 307  
 SCPI.SENSE.ATTenuation.LEVel, 307  
 SCPI.SENSE.FP(1-1).AVERAge.CLEAr, 308  
 SCPI.SENSE.FP(1-1).AVERAge.COUNt, 308  
 SCPI.SENSE.FP(1-1).AVERAge.STATe, 308  
 SCPI.SENSE.FP(1-1).FBAND, 309  
 SCPI.SENSE.FP(1-1).FREQuency.RESolution, 309  
 SCPI.SENSE.FP(1-1).SWEep.DWELl, 309  
 SCPI.SENSE.FP(1-1).SWEep.TIME.DATA, 310  
 SCPI.SENSE.PN(1-1).AVERAge.CLEAr, 310  
 SCPI.SENSE.PN(1-1).AVERAge.COUNt, 310  
 SCPI.SENSE.PN(1-1).AVERAge.STATe, 311  
 SCPI.SENSE.PN(1-1).CORRelation.COUNt, 311  
 SCPI.SENSE.PN(1-1).FBAND, 311  
 SCPI.SENSE.PN(1-1).FREQuency.STARt, 312  
 SCPI.SENSE.PN(1-1).FREQuency.STOP, 312  
 SCPI.SENSE.PN(1-1).IFGain, 313  
 SCPI.SENSE.PN(1-1).LOBandwidth, 313  
 SCPI.SENSE.PN(1-1).SEGTable.MEASurement.QUALity, 314  
 SCPI.SENSE.PN(1-1).SWEep.POINts, 314  
 SCPI.SENSE.ROSCillator.SOURce, 314  
 SCPI.SENSE.SP(1-1).AVERAge.CLEAr, 314  
 SCPI.SENSE.SP(1-1).AVERAge.COUNt, 315  
 SCPI.SENSE.SP(1-1).AVERAge.STATe, 315  
 SCPI.SENSE.SP(1-1).AVERAge.TYPE, 315  
 SCPI.SENSE.SP(1-1).BANDwidth.RESolution, 316  
 SCPI.SENSE.SP(1-1).CARRier.FBAND, 316  
 SCPI.SENSE.SP(1-1).CARRier.SET.CENTer, 317  
 SCPI.SENSE.SP(1-1).DETEctor.FUNCTion, 317  
 SCPI.SENSE.SP(1-1).FREQuency.CENTer, 317  
 SCPI.SENSE.SP(1-1).FREQuency.SPAN, 318  
 SCPI.SENSE.SP(1-1).FREQuency.STARt, 318  
 SCPI.SENSE.SP(1-1).FREQuency.STOP, 319  
 SCPI.SENSE.SP(1-1).POWER.RLEVel, 319  
 SCPI.SENSE.SP(1-1).SWEep.POINts, 320  
 SCPI.SENSE.TR(1-1).AVERAge.CLEAr, 320  
 SCPI.SENSE.TR(1-1).AVERAge.COUNt, 320  
 SCPI.SENSE.TR(1-1).AVERAge.STATe, 321  
 SCPI.SENSE.TR(1-1).NARRow.FREQuency.PREference, 321  
 SCPI.SENSE.TR(1-1).NARRow.FREQuency.RANGE, 321  
 SCPI.SENSE.TR(1-1).NARRow.FREQuency.TARGet, 322  
 SCPI.SENSE.TR(1-1).NARRow.SWEep.POINts, 322  
 SCPI.SENSE.TR(1-1).NARRow.TIME.OFFSet, 322  
 SCPI.SENSE.TR(1-1).NARRow.TIME.REFerence, 323  
 SCPI.SENSE.TR(1-1).NARRow.TIME.SPAN, 323  
 SCPI.SENSE.TR(1-1).POWER.INPut.LEVel.MAXimum, 324  
 SCPI.SENSE.TR(1-1).WIDE.FREQuency.MAXimum, 324  
 SCPI.SENSE.TR(1-1).WIDE.SWEep.POINts, 325  
 SCPI.SENSE.TR(1-1).WIDE.TIME.OFFSet, 325  
 SCPI.SENSE.TR(1-1).WIDE.TIME.REFerence, 325  
 SCPI.SENSE.TR(1-1).WIDE.TIME.SPAN, 326  
 SCPI.SOURce.FP(1-1).SWEep.PARAmeter, 326  
 SCPI.SOURce.FP(1-1).SWEep.POINts, 326  
 SCPI.SOURce.FP(1-1).VOLTage.CONTRol.CENTer, 327  
 SCPI.SOURce.FP(1-1).VOLTage.CONTRol.SPAN, 327  
 SCPI.SOURce.FP(1-1).VOLTage.CONTRol.STARt, 328  
 SCPI.SOURce.FP(1-1).VOLTage.CONTRol.STOP, 328  
 SCPI.SOURce.FP(1-1).VOLTage.POWER.CENTer, 329  
 SCPI.SOURce.FP(1-1).VOLTage.POWER.SPAN, 329  
 SCPI.SOURce.FP(1-1).VOLTage.POWER.STARt, 329  
 SCPI.SOURce.FP(1-1).VOLTage.POWER.STOP, 330  
 SCPI.SOURce.VOLTage.CONTRol.AFC.FBAND, 330  
 SCPI.SOURce.VOLTage.CONTRol.AFC.IMMediate, 331  
 SCPI.SOURce.VOLTage.CONTRol.AFC.ITERation, 331  
 SCPI.SOURce.VOLTage.CONTRol.AFC.LIMit.HIGH, 332  
 SCPI.SOURce.VOLTage.CONTRol.AFC.LIMit.LOW, 332  
 SCPI.SOURce.VOLTage.CONTRol.AFC.SENSitivity, 333  
 SCPI.SOURce.VOLTage.CONTRol.AFC.STATe, 333  
 SCPI.SOURce.VOLTage.CONTRol.AFC.TARGet, 334  
 SCPI.SOURce.VOLTage.CONTRol.AFC.TOLerance, 334  
 SCPI.SOURce.VOLTage.CONTRol.CORRection.COLlect.ACQuire, 335  
 SCPI.SOURce.VOLTage.CONTRol.CORRection.STATe, 335  
 SCPI.SOURce.VOLTage.CONTRol.DELay, 335

- SCPI.SOURce.VOLTage.CONTRol.LEVel.AMPLitude, 336
- SCPI.SOURce.VOLTage.CONTRol.LEVel.STATe, 336
- SCPI.SOURce.VOLTage.CONTRol.LIMit.HIGH, 337
- SCPI.SOURce.VOLTage.CONTRol.LIMit.LOW, 337
- SCPI.SOURce.VOLTage.POWer.DELay, 338
- SCPI.SOURce.VOLTage.POWer.LEVel.AMPLitude, 338
- SCPI.SOURce.VOLTage.POWer.LEVel.STATe, 339
- SCPI.SOURce.VOLTage.POWer.LIMit.HIGH, 339
- SCPI.SOURce.VOLTage.POWer.LIMit.LOW, 340
- SCPI.STATus.OPERation.BIT12.CLEAr, 341
- SCPI.STATus.OPERation.BIT12.CONDition, 341
- SCPI.STATus.OPERation.BIT12.ENABle, 341
- SCPI.STATus.OPERation.BIT12.EVENT, 342
- SCPI.STATus.OPERation.BIT12.NTRAnsition, 342
- SCPI.STATus.OPERation.BIT12.PTRAnsition, 342
- SCPI.STATus.OPERation.BIT12.SET, 343
- SCPI.STATus.OPERation.CONDition, 343
- SCPI.STATus.OPERation.ENABle, 343
- SCPI.STATus.OPERation.EVENT, 344
- SCPI.STATus.OPERation.NTRAnsition, 344
- SCPI.STATus.OPERation.PTRAnsition, 344
- SCPI.STATus.PRESet, 345
- SCPI.STATus.QUEStionable.CONDition, 345
- SCPI.STATus.QUEStionable.CURRent.ENABle, 345
- SCPI.STATus.QUEStionable.CURRent.EVENT, 345
- SCPI.STATus.QUEStionable.ENABle, 345
- SCPI.STATus.QUEStionable.EVENT, 346
- SCPI.STATus.QUEStionable.LIMit.CONDition, 346
- SCPI.STATus.QUEStionable.LIMit.ENABle, 346
- SCPI.STATus.QUEStionable.LIMit.EVENT, 347
- SCPI.STATus.QUEStionable.LIMit.FP(1-1).CONDition, 347
- SCPI.STATus.QUEStionable.LIMit.FP(1-1).ENABle, 347
- SCPI.STATus.QUEStionable.LIMit.FP(1-1).EVENT, 347
- SCPI.STATus.QUEStionable.LIMit.FP(1-1).NTRAnsition, 347
- SCPI.STATus.QUEStionable.LIMit.FP(1-1).PTRAnsition, 348
- SCPI.STATus.QUEStionable.LIMit.NTRAnsition, 348
- SCPI.STATus.QUEStionable.LIMit.PN(1-1).CONDition, 349
- SCPI.STATus.QUEStionable.LIMit.PN(1-1).ENABle, 349
- SCPI.STATus.QUEStionable.LIMit.PN(1-1).EVENT, 349
- SCPI.STATus.QUEStionable.LIMit.PN(1-1).NTRAnsition, 349
- SCPI.STATus.QUEStionable.LIMit.PN(1-1).PTRAnsition, 350
- SCPI.STATus.QUEStionable.LIMit.PTRAnsition, 350
- SCPI.STATus.QUEStionable.LIMit.SP(1-1).CONDition, 351
- SCPI.STATus.QUEStionable.LIMit.SP(1-1).ENABle, 351
- SCPI.STATus.QUEStionable.LIMit.SP(1-1).EVENT, 351
- SCPI.STATus.QUEStionable.LIMit.SP(1-1).NTRAnsition, 351
- SCPI.STATus.QUEStionable.LIMit.SP(1-1).PTRAnsition, 352
- SCPI.STATus.QUEStionable.LIMit.TR(1-1).CONDition, 352
- SCPI.STATus.QUEStionable.LIMit.TR(1-1).ENABle, 352
- SCPI.STATus.QUEStionable.LIMit.TR(1-1).EVENT, 353
- SCPI.STATus.QUEStionable.LIMit.TR(1-1).NTRAnsition, 353
- SCPI.STATus.QUEStionable.LIMit.TR(1-1).PTRAnsition, 353
- SCPI.STATus.QUEStionable.LIMit.USER(1-1).CONDition, 354
- SCPI.STATus.QUEStionable.LIMit.USER(1-1).ENABle, 354
- SCPI.STATus.QUEStionable.LIMit.USER(1-1).EVENT, 354
- SCPI.STATus.QUEStionable.LIMit.USER(1-1).NTRAnsition, 355
- SCPI.STATus.QUEStionable.LIMit.USER(1-1).PTRAnsition, 355
- SCPI.STATus.QUEStionable.MISC.ENABle, 355
- SCPI.STATus.QUEStionable.MISC.EVENT, 356
- SCPI.STATus.QUEStionable.NTRAnsition, 356
- SCPI.STATus.QUEStionable.PHASE.ENABle, 356
- SCPI.STATus.QUEStionable.PHASE.EVENT, 357
- SCPI.STATus.QUEStionable.POWer.ENABle, 357
- SCPI.STATus.QUEStionable.POWer.EVENT, 357
- SCPI.STATus.QUEStionable.PTRAnsition, 358
- SCPI.STATus.QUEStionable.REFerence.ENABle, 358
- SCPI.STATus.QUEStionable.REFerence.EVENT, 358
- SCPI.SYSTem.BACKlight.STATe, 359
- SCPI.SYSTem.BEEPer.COMPLete.IMMEDIATE, 359
- SCPI.SYSTem.BEEPer.COMPLete.STATe, 359
- SCPI.SYSTem.BEEPer.WARNing.IMMEDIATE, 360
- SCPI.SYSTem.BEEPer.WARNing.STATe, 360
- SCPI.SYSTem.DATE[\_Q] year, month, day, 361
- SCPI.SYSTem.ERRor.NEXT\_Q err\_no, err\_desc, 361
- SCPI.SYSTem.KLOCK.KBD, 362
- SCPI.SYSTem.KLOCK.MOUSE, 362
- SCPI.SYSTem.POFF, 362
- SCPI.SYSTem.PRESet, 363
- SCPI.SYSTem.TIME[\_Q] hour, minute, second, 363
- SCPI.TRIGger.EXTernal.SLOPe, 364
- SCPI.TRIGger.FP(1-1).MODE, 364
- SCPI.TRIGger.FP(1-1).SOURce, 365
- SCPI.TRIGger.MODE, 365
- SCPI.TRIGger.PN(1-1).SOURce, 365
- SCPI.TRIGger.SP(1-1).SOURce, 366
- SCPI.TRIGger.TR(1-1).NARRow.VIDeo.FREQUency.CENTer, 366
- SCPI.TRIGger.TR(1-1).NARRow.VIDeo.THREShold, 367
- SCPI.TRIGger.TR(1-1).SOURce, 367
- SCPI.TRIGger.TR(1-1).WIDE.VIDeo.FREQUency.CENTer, 368
- control system, 29
- Controlling VBA Externally, 81

## D

- data hint, 60

debug, 56  
 debug tool, 58  
 description, 102  
 DoEvents, 79  
 Double, 103  
 double precision floating point type, 103

**E**

E5052 Event, 71, 77  
 E5052Lib, 67  
 Echo Font Size, 64  
 Echo Window, 64  
 echo window, 64  
 editor, 34  
 equivalent key, 103  
 error, 56  
 event, 31  
 event interruption, 71  
 event occurrence, 80  
 examples, 103  
 export, 46

**F**

formatted data array, 72  
 formatted memory array, 72

**H**

help, 65

**I**

immediate window, 61  
 import, 49  
 index tab, 66  
 internal data, 72

**L**

label name, 76  
 Limit Test, 74  
 load, 48  
 Load & Run, 53  
 Load Project, 48  
 local window, 60  
 Long, 103  
 long integer type, 103

**M**

Macro Break, 54  
 Macro dialog box, 53  
 macro function, 28  
 Macro Name, 52, 53  
 measurement window, 26  
 menu bar, 34  
 method, 31  
 module, 37

**N**

New Project, 38

**O**

object browser, 67  
 OnEvent, 80  
 Open Editor, 34  
 operation status condition register, 70  
 operation status event register, 70

**P**

part number, 2  
 peripheral, 30  
 project, 37  
 project explorer, 35  
 property, 31  
 property window, 35

**Q**

quick watch, 63

**R**

raw data array, 72  
 Reset, 55  
 Run Macro, 51

**S**

save, 45  
 Save Project, 46  
 SCPI object, 101  
 Select Macro, 53  
 serial number, 458  
 softkey  
   executing a VBA program in the VBA folder, 53  
 SRQ, 70  
 standard module, 37  
 status register, 70  
 stop, 54  
 String, 103  
 syntax, 102

**T**

toolbar, 34  
 trigger, 70  
 trigger source, 70  
 trigger system, 70  
 typeface, 3

**U**

unformatted data arrays, 72  
 unformatted memory array, 72  
 USB/GPIB interface, 29  
 user form, 37  
 User Label, 76

---

User Label No., 77  
user menu, 76  
using peripherals, 30

## V

Variant, 103  
Variant type, 103  
variant variable, 73  
VBA, 28  
version, 458  
viClose, 98  
viOpen, 96  
viOpenDefaultRM, 96  
VISA, 29, 30, 94, 95  
visa32.bas, 94  
viVPrintf, 97  
viVScanf, 97  
vpptype.bas, 94

## W

watch window, 62

## X

X-axis data array, 72